



Rettungsdatenblätter Volkswagen

Modellübersicht

Modell- bezeichnung

Modell- zyklus

Modell- bezeichnung

Modell- zyklus

A

- **Amarok** (2-Türer) ab 2011
Amarok (4-Türer) ab 2010
- **Arteon** (4-Türer) ab 2017

B

- **Beetle** ab 1998
Beetle ab 2011
Beetle (Cabrio) ab 2003
Beetle (Cabrio) ab 2013
- **Bora** (Limousine) ab 1998
Bora (Variant) ab 1999

C

- **Caddy** (Kombi) ab 1996
Caddy (Pickup) ab 1997
Caddy (Kombi) ab 2004
Caddy (Kombi EcoFuel) ab 2006
Caddy ab 2010
Caddy (EcoFuel) ab 2010
Caddy (Bifuel) ab 2010
Caddy ab 2015
Caddy (EcoFuel) ab 2015
Caddy Maxi ab 2007
Caddy Maxi (EcoFuel) ab 2007
Caddy Maxi ab 2010
Caddy Maxi (EcoFuel) ab 2010
Caddy Maxi (Bifuel) ab 2010
Caddy Maxi ab 2015
Caddy Maxi (EcoFuel) ab 2015
- **Corrado** ab 1988
- **Crafter** ab 2006
Crafter Fahrgest. (2-Türer) ab 2006
Crafter Fahrgest. (4-Türer) ab 2006
Crafter ab 2017
Crafter Fahrgest. (2-Türer) ab 2017
Crafter Fahrgest. (4-Türer) ab 2017
e-Crafter ab 2018

E

- **Eos** ab 2006

F

- **Fox** ab 2005

G

- **Golf 3** (3-Türer) ab 1991
Golf 3 (5-Türer) ab 1991
Golf 3 (Variant) ab 1993
Golf 3 (Cabrio) ab 1993
- **Golf 4** (3-Türer) ab 1997
Golf 4 (5-Türer) ab 1997
Golf 4 (Variant) ab 1999
Golf 4 (Cabrio) ab 1998
Golf 4 (Variant BiFuel) ab 2003
- **Golf 5** (3-Türer) ab 2003
Golf 5 (5-Türer) ab 2003
Golf 5 Plus ab 2005
Golf 5 (Variant) ab 2006
- **Golf 6** (3-Türer) ab 2008
Golf 6 (5-Türer) ab 2008
Golf 6 (3-Türer BiFuel) ab 2009
Golf 6 (5-Türer BiFuel) ab 2009
Golf 6 (Variant) ab 2009
Golf 6 Plus ab 2009
Golf 6 Plus (BiFuel) ab 2009
Golf 6 (Cabrio) ab 2011
- **Golf 7** (3-Türer) ab 2012
Golf 7 (5-Türer) ab 2012
Golf 7 (Variant) ab 2013
Golf 7 TGI (5-Türer) ab 2013
Golf 7 TGI (Variant) ab 2014
Golf 7 (Sportsvan) ab 2014
e-Golf 7 ab 2014
Golf 7 GTE ab 2014

J

- **Jetta** ab 2005
Jetta ab 2010
Jetta Hybrid ab 2012



Rettungsdatenblätter Volkswagen

Modellübersicht (Fortsetzung)

Modell- bezeichnung

Modell- zyklus

L

- **Lupo** ab 1998

P

- **Passat B4** (Limousine) ab 1993
Passat B4 (Variant) ab 1993
- **Passat B5** (Limousine) ab 1996
Passat B5 (Variant) ab 1997
- **Passat B6** (Limousine) ab 2005
Passat B6 (Variant) ab 2005
Passat B6 (Lim. EcoFuel) ab 2009
Passat B6 (Var. EcoFuel) ab 2009
- **Passat B7** (Limousine) ab 2010
Passat B7 (Variant) ab 2010
Passat B7 (Lim. EcoFuel) ab 2010
Passat B7 (Var. EcoFuel) ab 2010
- **Passat B8** (Limousine) ab 2014
Passat B8 (Variant) ab 2014
Passat B8 GTE (Limousine) ab 2015
Passat B8 GTE (Variant) ab 2015
- **Passat CC** ab 2008
- **Phaeton** ab 2002
- **Polo A03** (3-Türer) ab 1994
Polo A03 (5-Türer) ab 1994
Polo A03 (Variant) ab 1994
Polo A03 (Stufenheck) ab 1994
- **Polo A04** (3-Türer) ab 2001
Polo A04 (5-Türer) ab 2001
Polo A04 (Stufenheck) ab 2001
- **Polo A05** (3-Türer) ab 2009
Polo A05 (5-Türer) ab 2009
Polo A05 (3-Türer BiFuel) ab 2009
Polo A05 (5-Türer BiFuel) ab 2009
- **Polo A06** (5-Türer) ab 2017

Modell- bezeichnung

Modell- zyklus

S

- **Scirocco** ab 2008
- **Sharan** ab 1995
Sharan (BiFuel) ab 2006
Sharan ab 2010

T

- **T-Roc** ab 2017
- **Tiguan** ab 2007
Tiguan ab 2016
- **Touareg** ab 2002
Touareg ab 2010
Touareg Hybrid ab 2010
Touareg ab 2018
- **Touran** ab 2003
Touran (EcoFuel) ab 2005
Touran ab 2006
Touran (EcoFuel) ab 2006
Touran 5-Sitzer ab 2010
Touran 7-Sitzer ab 2010
Touran 5-Sitzer (EcoFuel) ab 2010
Touran 7-Sitzer (EcoFuel) ab 2010
Touran 7-Sitzer ab 2015
- **Transporter LT2** ab 1996
Tr. LT2 Fahrgest. 2-Türer ab 1996
Tr. LT2 Fahrgest. 4-Türer ab 1996
- **Transporter T4** ab 1991
Tr. T4 Fahrgest. 2-Türer ab 1991
Tr. T4 Fahrgest. 4-Türer ab 1991
- **Transporter T5** ab 2003
Tr. T5 Fahrgest. 2-Türer ab 2003
Tr. T5 Fahrgest. 4-Türer ab 2003
Tr. T5 California ab 2003
- **Transporter T5** ab 2010
Tr. T5 Fahrgest. 2-Türer ab 2010
Tr. T5 Fahrgest. 4-Türer ab 2010
Tr. T5 California ab 2010



Modell-
bezeichnung

Modell-
zyklus

Modell-
bezeichnung

Modell-
zyklus

T

- **Transporter T6**
Tr. T6 Fahrgest. 2-Türer
Tr. T6 Fahrgest. 4-Türer
Tr. T6 California

ab 2015
ab 2015
ab 2015
ab 2015

U

- **up!**
up! (3-Türer)
up! (5-Türer)
up! Ecofuel (3-Türer)
up! Ecofuel (5-Türer)
e-up!

ab 2011
ab 2011
ab 2013
ab 2013
ab 2013

V

- **Vento**

ab 1992

X

- **XL1**

ab 2014



Hinweis

In den Rettungsdatenblättern ist immer die maximal mögliche Ausstattung eines Fahrzeuges gemäß der von Volkswagen vorgesehenen Ausstattungsvarianten eines Modells abgebildet.

Rechtlicher Hinweis:

Diese Rettungsdatenblätter wurden ausschließlich für Rettungskräfte erstellt, die über eine spezielle Ausbildung auf dem Gebiet der technischen Hilfeleistung nach Verkehrsunfällen verfügen und damit die in diesen Datenblättern beschriebenen Tätigkeiten ausführen können. Ferner enthalten die Rettungsdatenblätter Informationen über Fahrzeuge, die zum Verkauf in der Europäischen Union bestimmt sind. Die Rettungsdatenblätter enthalten hingegen keine Informationen über Fahrzeuge, die zum Verkauf außerhalb der Europäischen Union bestimmt sind. Spezifikationen und Sonderausstattungen der Volkswagen Fahrzeuge sowie das Fahrzeugangebot der Volkswagen Aktiengesellschaft unterliegen stetig etwaigen Änderungen. Daher behält sich Volkswagen inhaltliche Anpassungen bzw. Änderungen an den Rettungsdatenblättern jederzeit ausdrücklich vor.

Beachten Sie bitte:

Die in den Rettungsdatenblättern enthaltenen Informationen sind nicht für Endkunden und ebenfalls nicht für Werkstätten und Händler bestimmt. Endkunden können den Bordbüchern ihres jeweiligen Fahrzeuges der Volkswagen AG Informationen zu den Funktionen ihres Fahrzeuges sowie wichtige Sicherheitshinweise zur Fahrzeug- und Insassensicherheit entnehmen. Werkstätten und Händler erhalten Service- und Reparaturinformationen über die ihnen bekannten Bezugsquellen.

Einen allgemeinen Teil mit Hinweisen zur technischen Hilfeleistung finden Sie in den Rettungsleitfäden „Hinweise zur Unfallrettung aus verunfallten Fahrzeugen der Volkswagen AG mit Sicherheitssystemen“ (Artikel-Nr. 001.2200.50.00) und „Hinweise zur Unfallrettung aus verunfallten Fahrzeugen der Volkswagen AG mit alternativen Antrieben“ (Artikel-Nr. 000.2200.56.00). Die Rettungsdatenblätter sind in interaktiver Form auch in der Datenbank „Crash Recovery System“ enthalten. Weitere Informationen zu dieser Datenbank erhalten Sie unter **www.moditech.com**.

(Stand: November 2011)

Artikelnummer: 002.2200.51.00



Rettungsdatenblätter Volkswagen

Typbezeichnungen in numerischer Reihenfolge

Typ- bezeichnung

Modell- bezeichnung

1

- **13** Scirocco
- **1E** Golf 3 (Cabrio)
- **1F** Eos
- **1G** Jetta
- **1H** Golf 3
- **1J** Golf 4
Golf 4 (Variant)
Bora
Bora (Variant)
- **1K** Golf 5
Golf 6
- **1KM** Golf 6 (Variant)
- **1KP** Golf 5 Plus
Golf 6 Plus
- **1T** Touran
- **1T0** Touran (ab 2010)
- **1Y** Beetle (Cabrio)

2

- **2DM** Transporter LT2
- **2EC** Crafter
- **2K** Caddy

3

- **35** Passat B5 (Limousine)
Passat B5 (Variant)
- **3A** Passat B4 (Limousine)
Passat B4 (Variant)
- **3C** Passat B6 (Limousine)
Passat B6 (Variant)
- **3CC** Passat CC
- **3D** Phaeton

Typ- bezeichnung

Modell- bezeichnung

5

- **53** Corrado
- **5N** Tiguan
- **5Z** Fox

6

- **6E(S)** Lupo (3l)
- **6N** Polo A03
Polo A03 (Variant)
Polo A03 (Stufenheck)
- **6R** Polo A05
- **6X** Lupo GTI

7

- **7D** Transporter T4
- **7H** Transporter T5
- **7J** Transporter T5 (Pritsche)
- **7L** Touareg
- **7M** Sharan
- **7P** Touareg (ab 2010)

9

- **9C** Beetle
- **9N** Polo A04
- **9U** Caddy Pickup







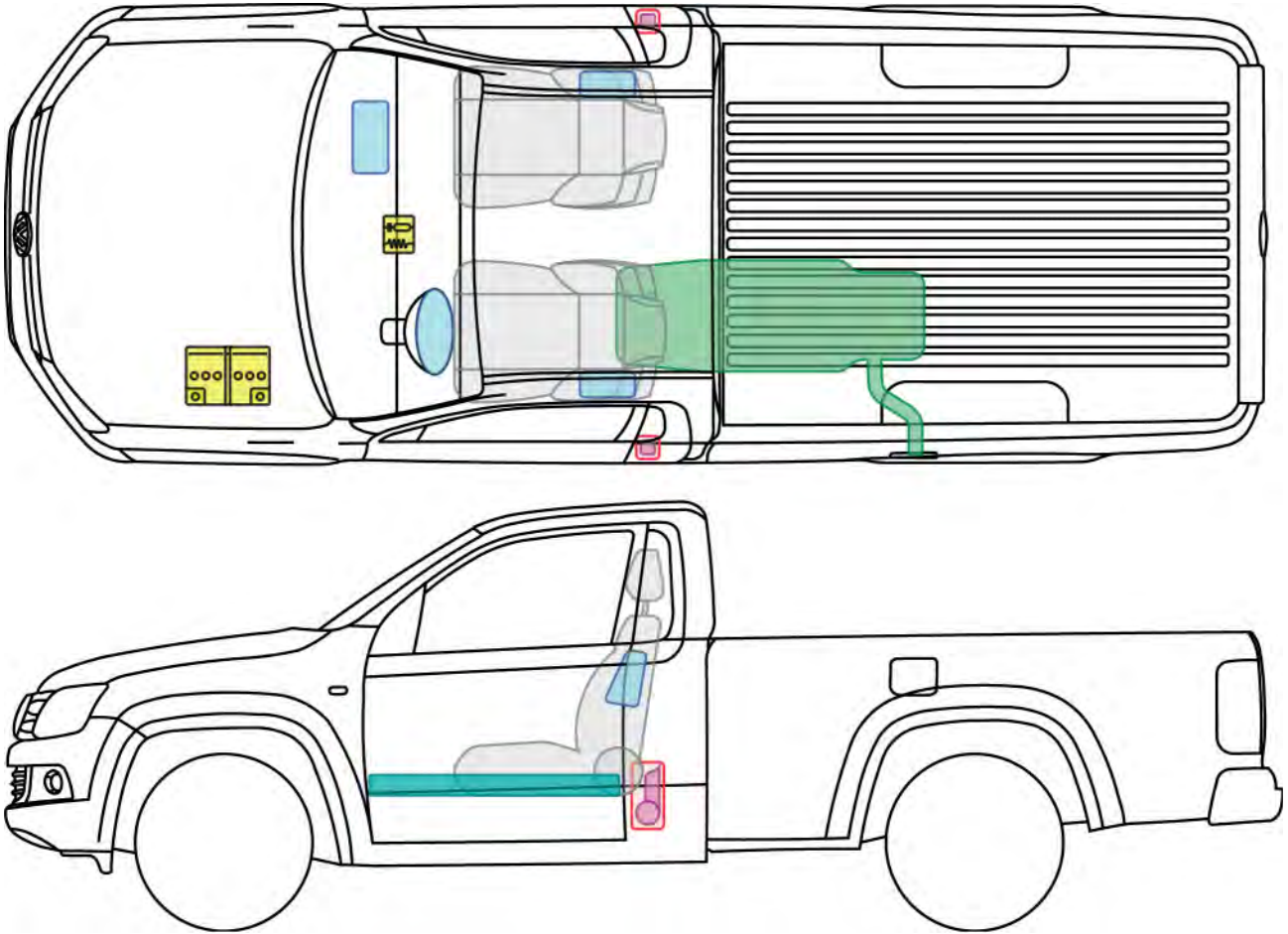

Amarok

(2-Türer, ab 2011)



Legende

	Airbag		Karosserie-Verstärkung		Steuergerät
					12V-Batterie
	Gurtstraffer				Kraftstoff-tank

A

Amarok (2-Türer, ab 2011)







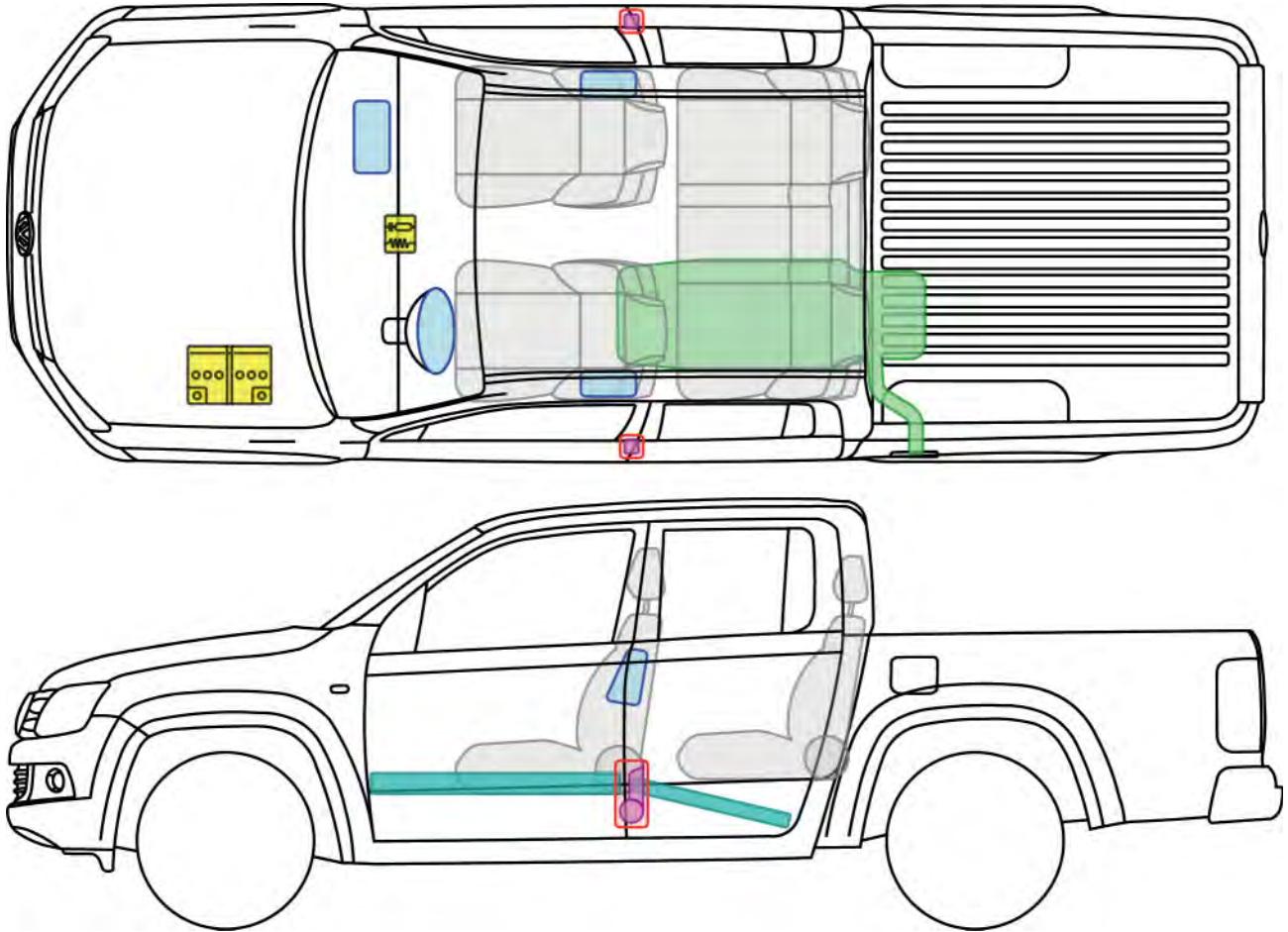

Amarok

(4-Türer, ab 2010)



Legende

	Airbag		Karosserie-Verstärkung		Steuergerät	
					12V-Batterie	
	Gurtstraffer				Kraftstoff-tank	







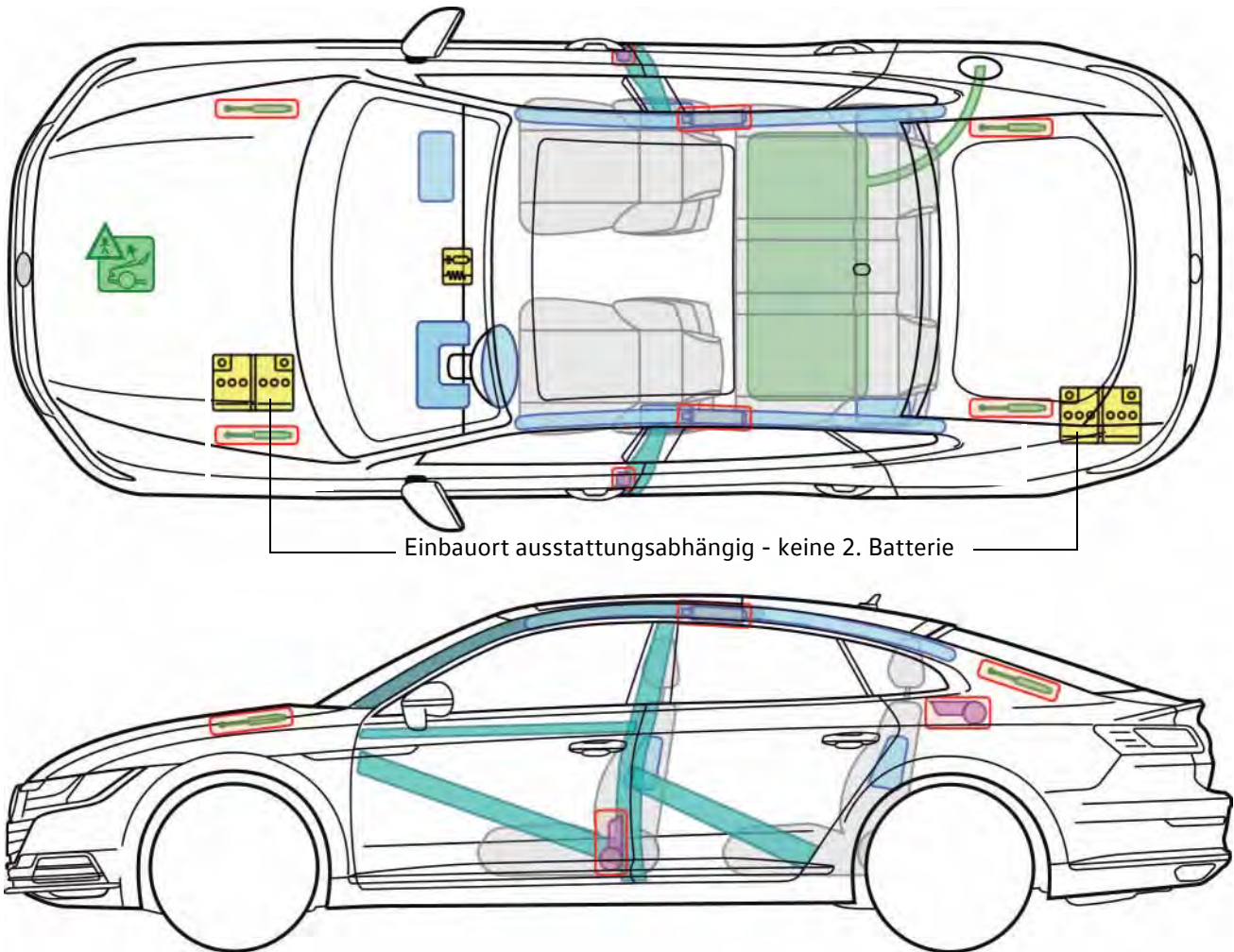



Arteon

(ab 2017)



Legende

	Airbag		Karosserie-Verstärkung		Steuergerät	
	Gas-generator				12V-Batterie	
	Gurtstraffer		Gasdruck-dämpfer		Kraftstoff-tank	 aktive Frontklappe



Arteon
(ab 2017)



Fahrzeug deaktivieren

Batterie abklemmen (bei Einbauort Kofferraum)

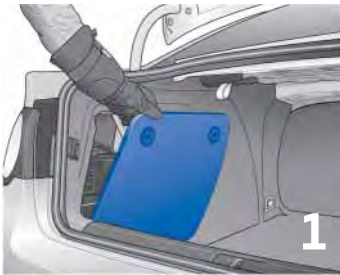

1. Batterieabdeckung im Kofferraum entfernen

- Batterieabdeckung im Kofferraum auf der linken Fahrzeugseite lokalisieren
- Befestigungsschrauben lösen und Abdeckung abnehmen

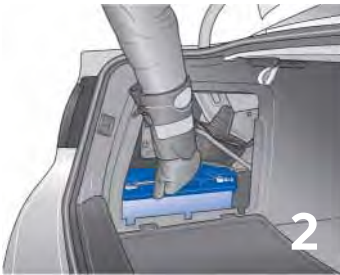

2. Masseanschluss (-) an der Batterie abklemmen

A

Arteon (ab 2017)







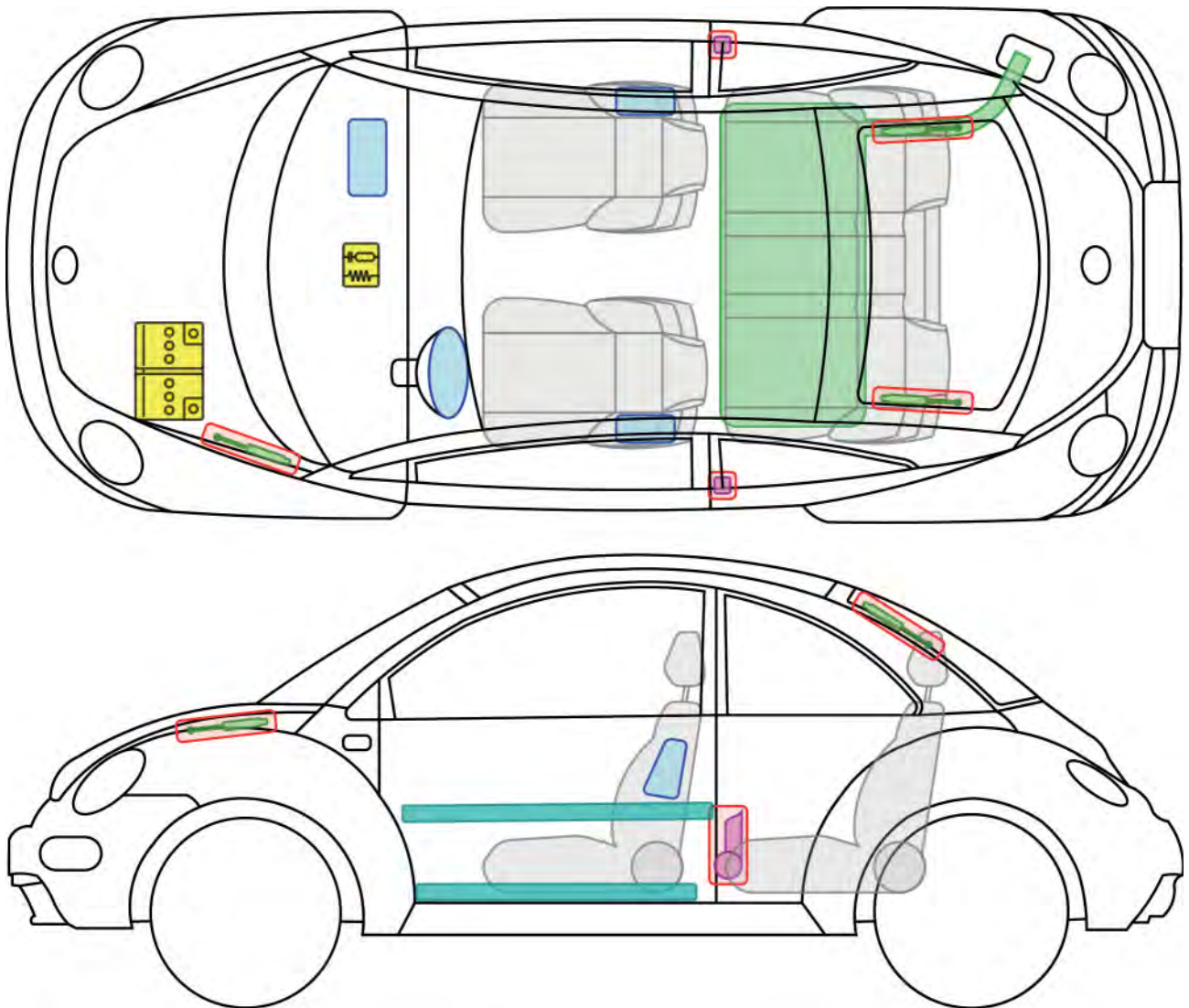

Beetle

(ab 1998)



Legende

	Airbag		Karosserie-Verstärkung		Steuergerät
					12V-Batterie
	Gurtstraffer		Gasdruck-dämpfer		Kraftstoff-tank

B

Beetle (ab 1998)







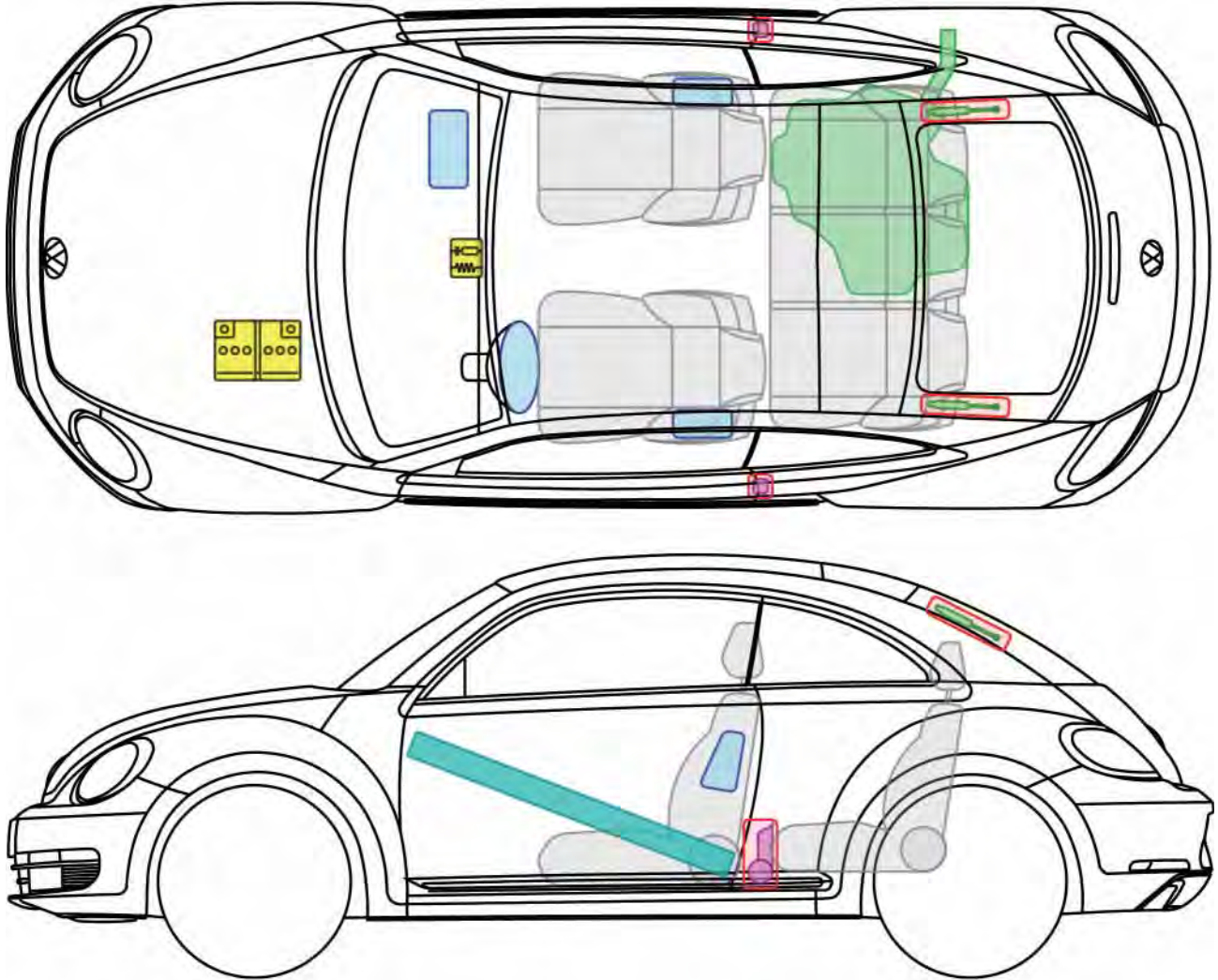

Beetle

(ab 2011)



Legende

	Airbag		Karosserie-Verstärkung		Steuergerät
					12V-Batterie
	Gurtstraffer		Gasdruck-dämpfer		Kraftstoff-tank

B

Beetle (ab 2011)







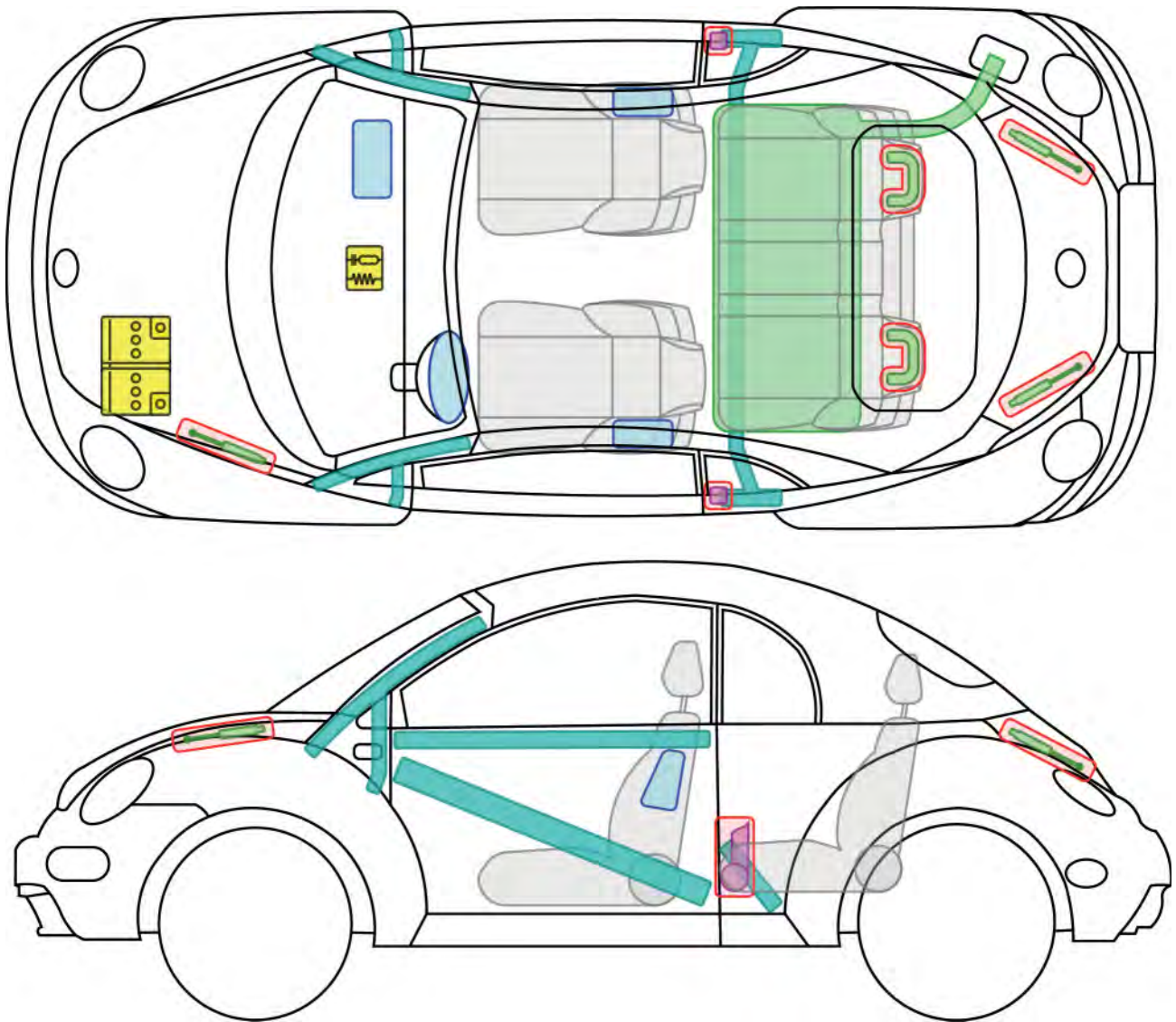



Beetle

(Cabrio, ab 2003)



Legende

	Airbag		Karosserie-Verstärkung		Steuergerät
			Überrollschutz		12V-Batterie
	Gurtstraffer		Gasdruckdämpfer		Kraftstoff-tank

B

Beetle (Cabrio, ab 2003)







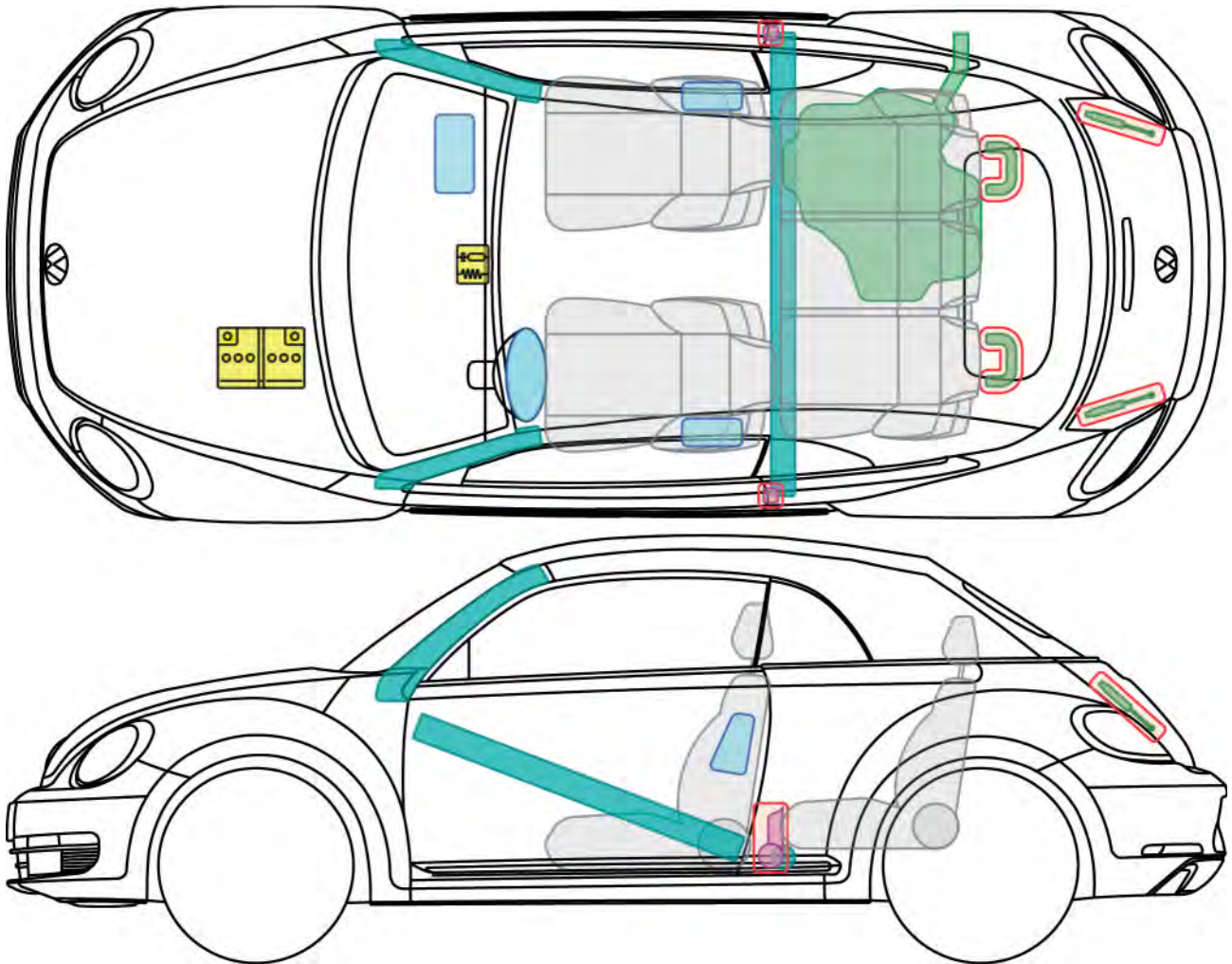



Beetle

(Cabrio, ab 2013)



Legende

	Airbag		Karosserie-Verstärkung		Steuergerät	
			Überrollschutz		12V-Batterie	
	Gurtstraffer		Gasdruckdämpfer		Kraftstoff-tank	

B

Beetle (Cabrio, ab 2013)







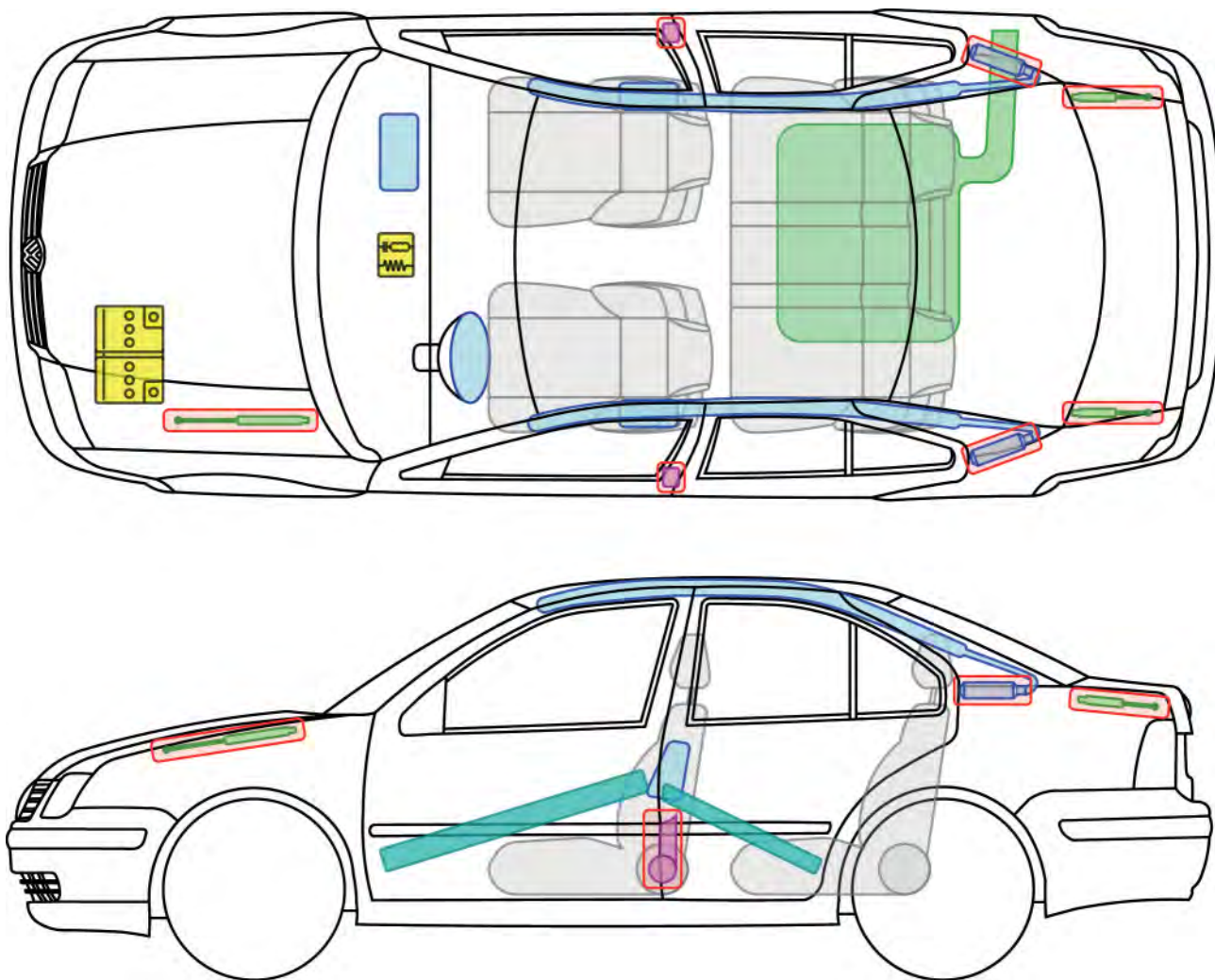



Bora

(Limousine, ab 1998)



Legende

	Airbag		Karosserie-Verstärkung		Steuergerät
	Gas-generator				12V-Batterie
	Gurtstraffer		Gasdruck-dämpfer		Kraftstoff-tank

B

Bora (Limousine, ab 1998)







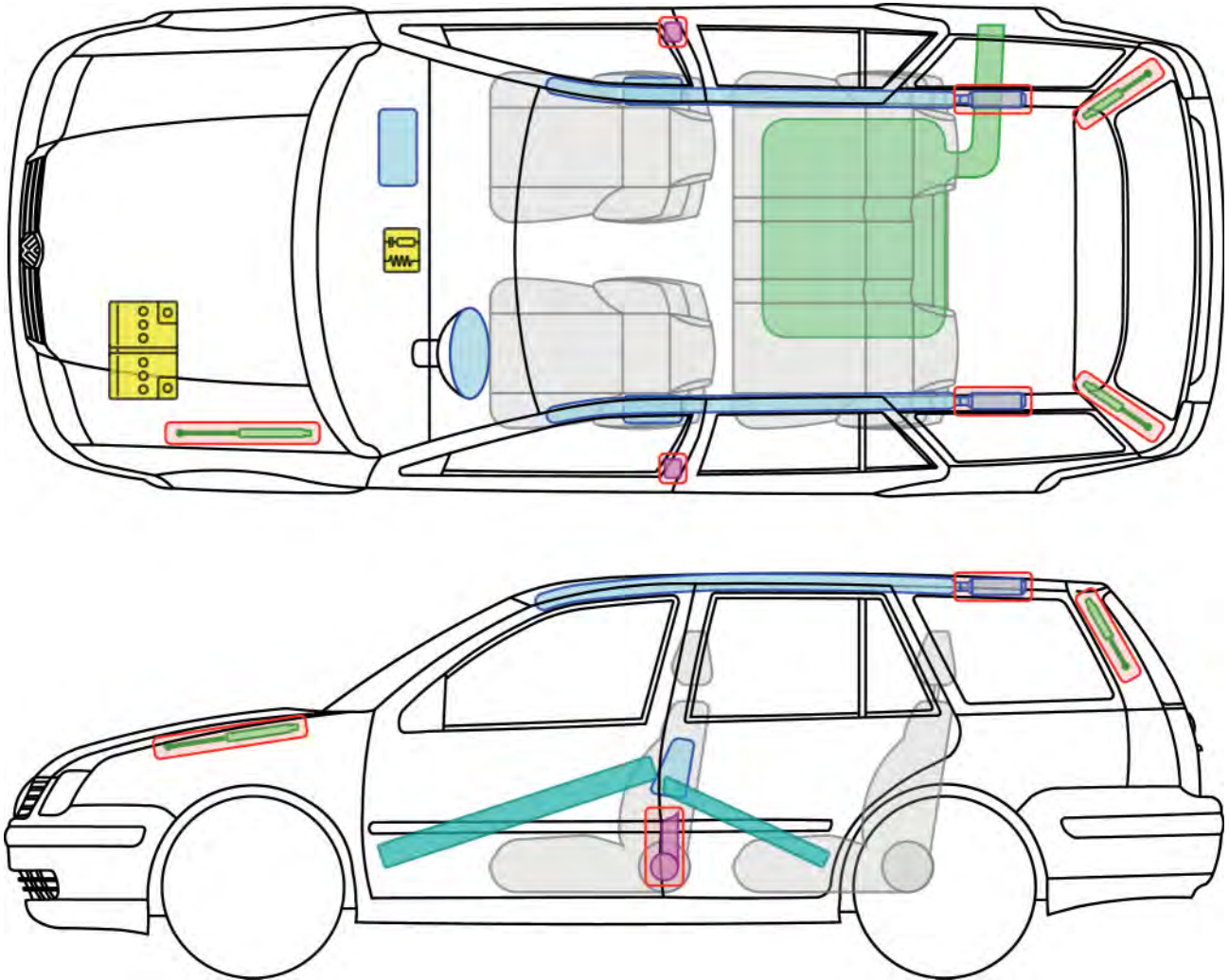



Bora

(Variant, ab 1999)



Legende

	Airbag		Karosserie-Verstärkung		Steuergerät
	Gas-generator				12V-Batterie
	Gurtstraffer		Gasdruck-dämpfer		Kraftstoff-tank







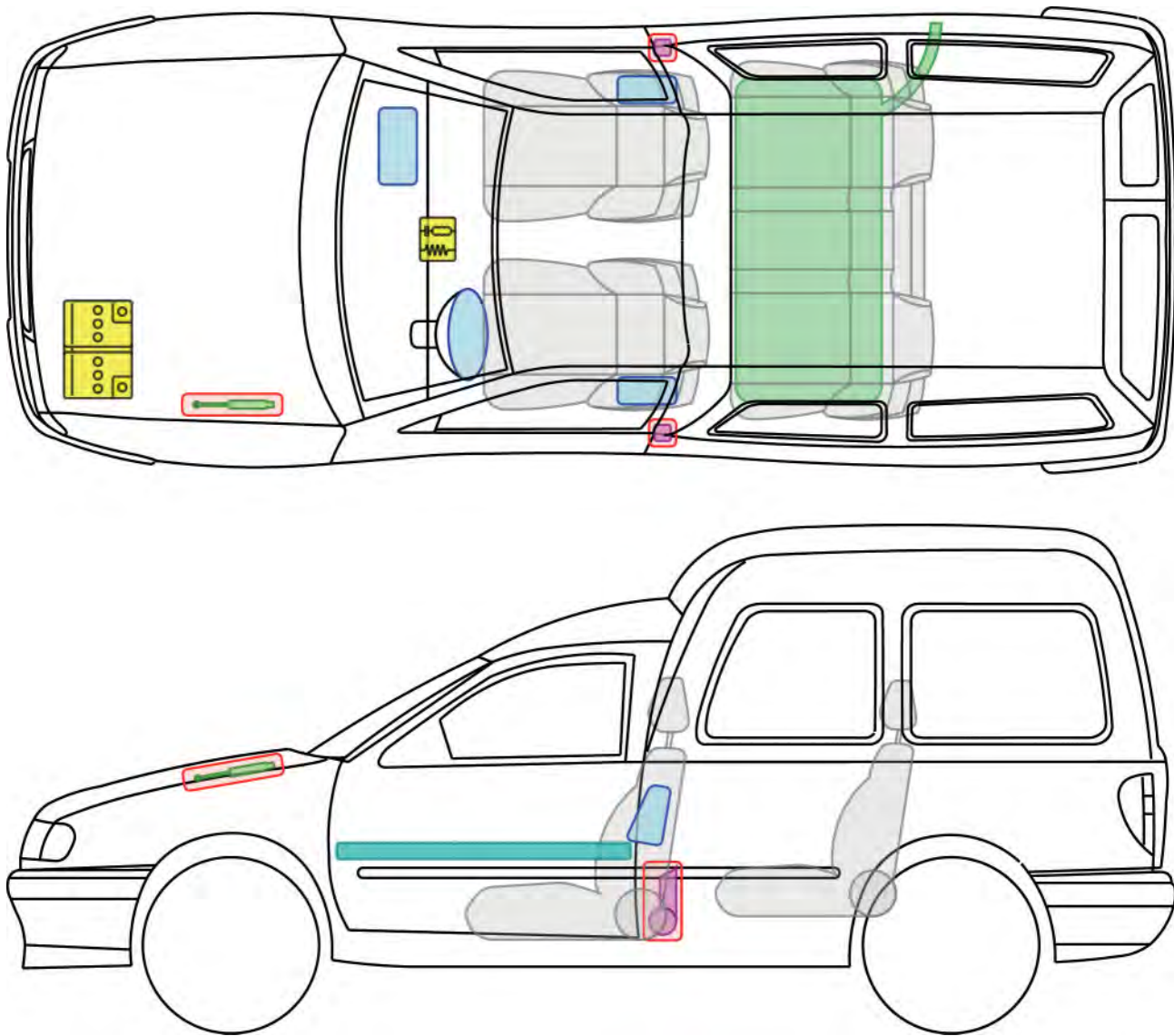

Caddy

(Kombi, ab 1996)

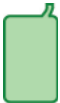

Legende

	Airbag		Karosserie-Verstärkung		Steuergerät
					12V-Batterie
	Gurtstraffer		Gasdruck-dämpfer		Kraftstoff-tank







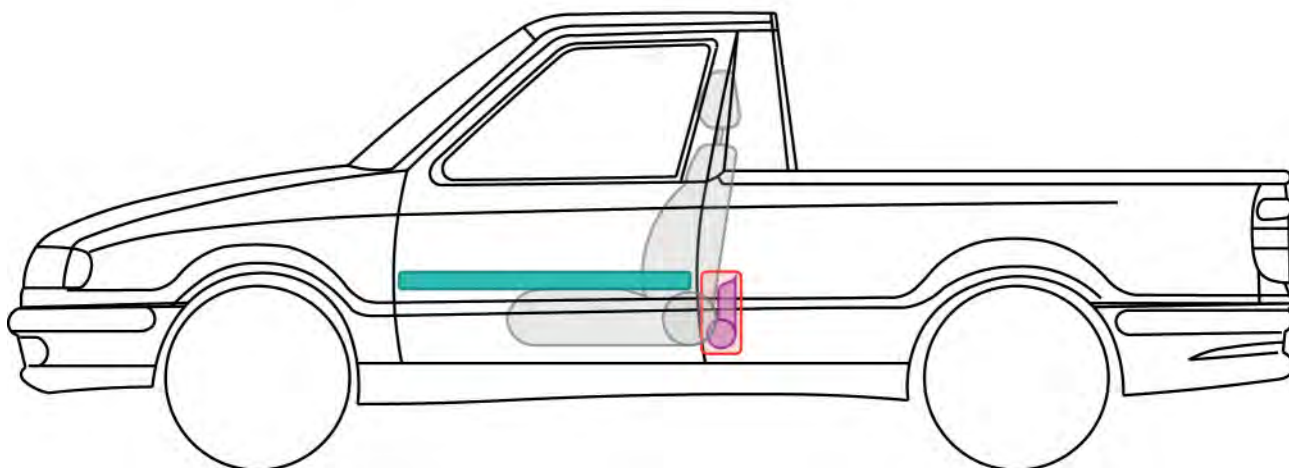
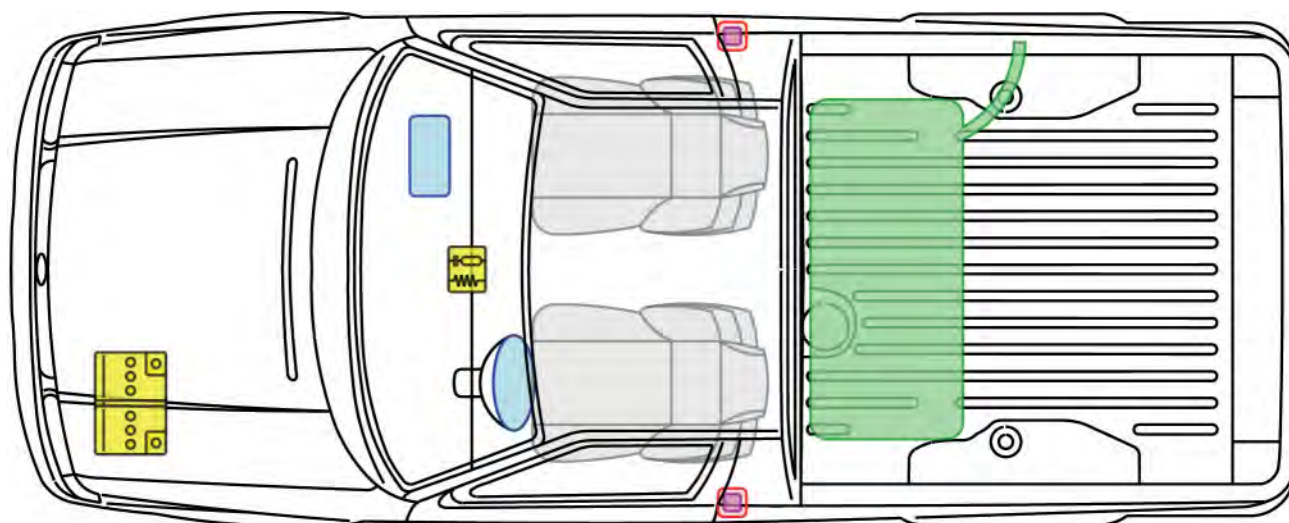

Caddy

(Pickup, ab 1997)



Legende

	Airbag		Karosserie-Verstärkung		Steuergerät
					12V-Batterie
	Gurtstraffer				Kraftstoff-tank



Caddy

(Kombi, ab 2004)

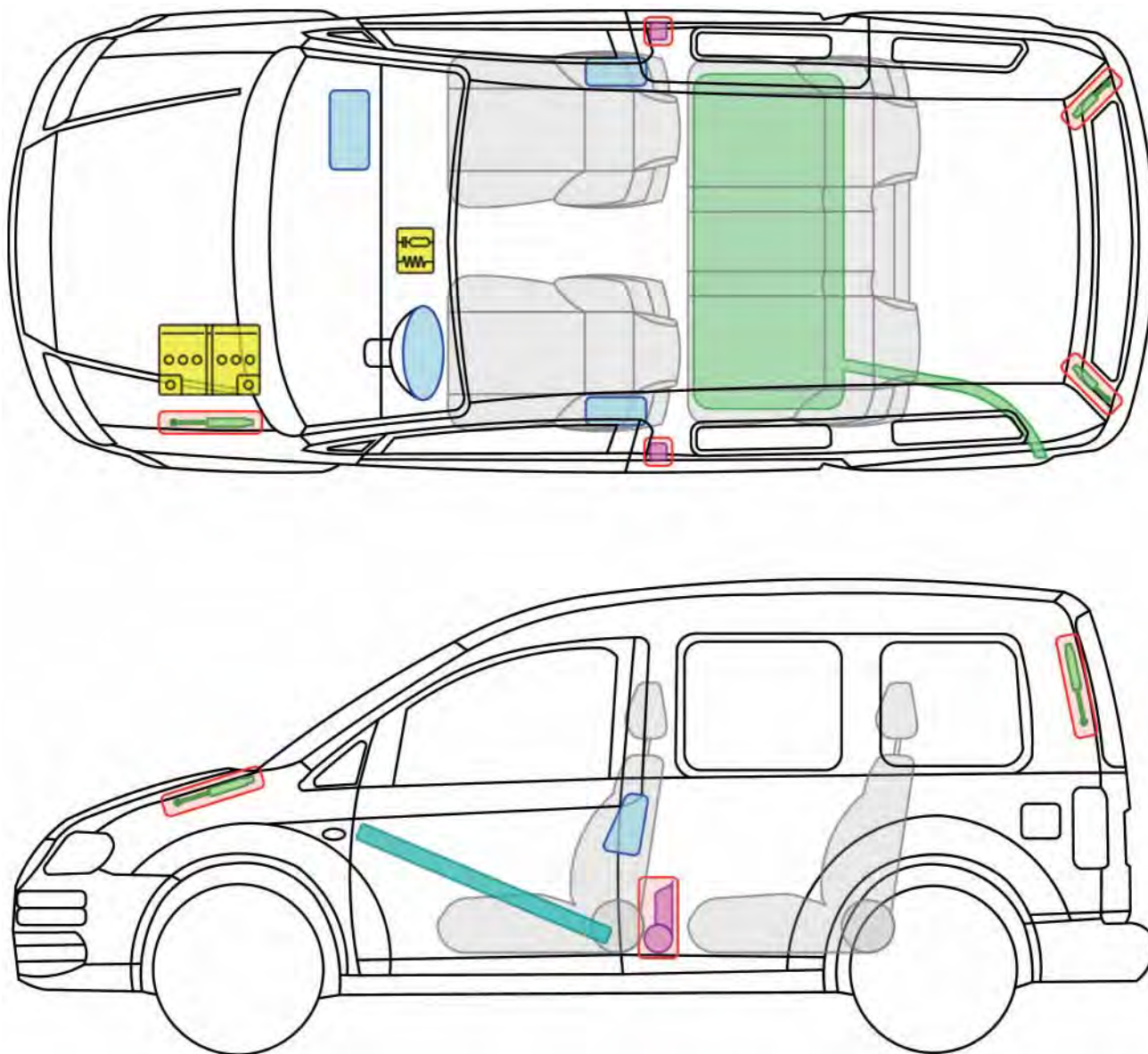

Legende

	Airbag		Karosserie-Verstärkung		Steuergerät
					12V-Batterie
	Gurtstraffer		Gasdruck-dämpfer		Kraftstoff-tank



Caddy

(Kombi EcoFuel, ab 2006)

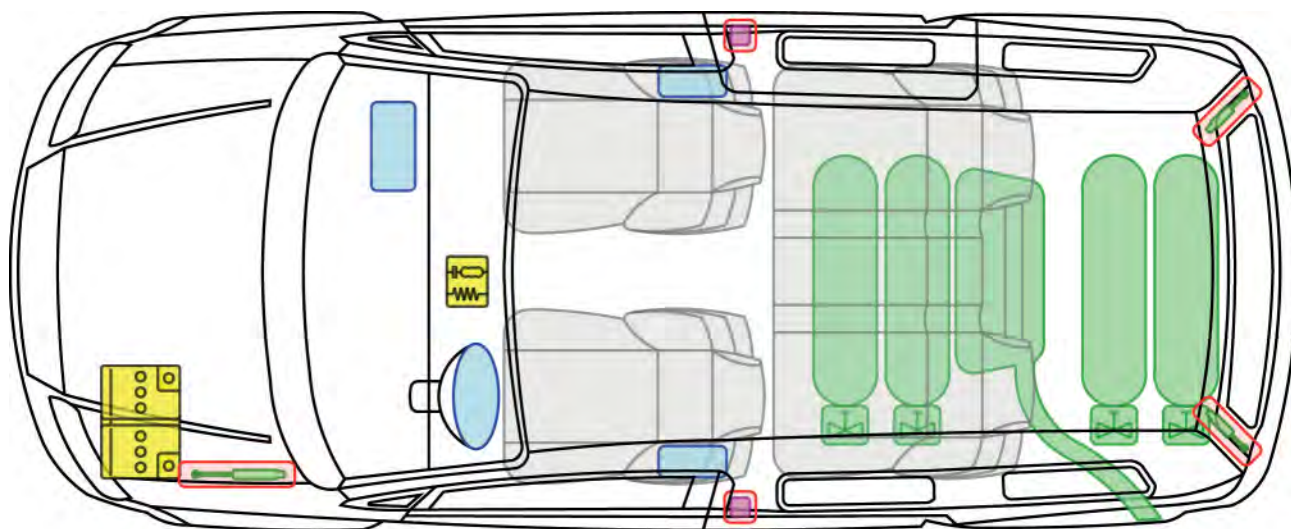





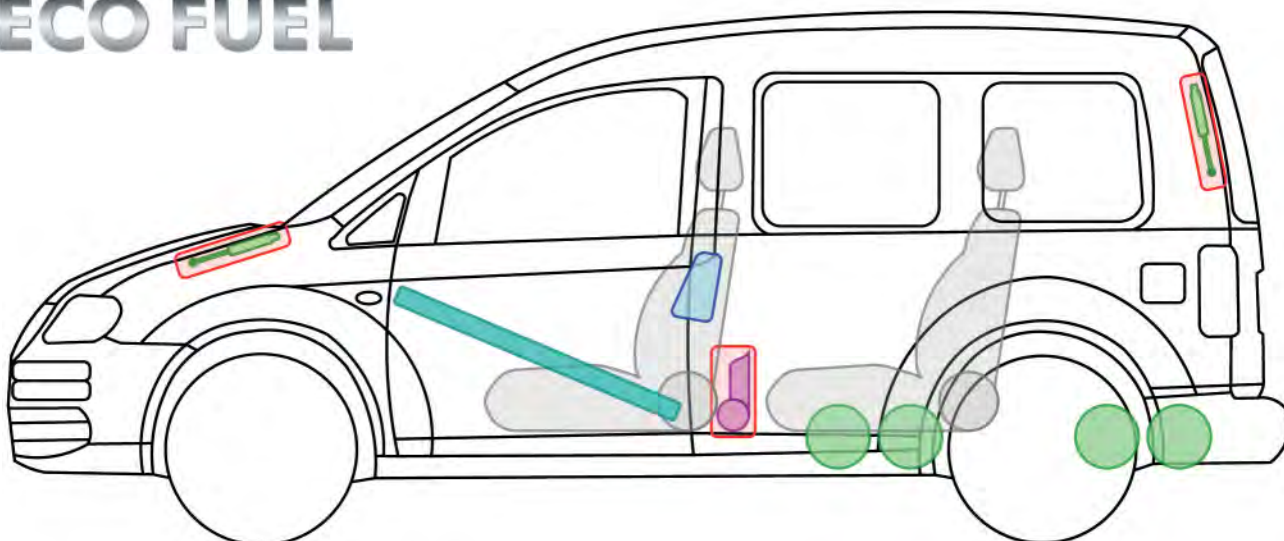



Erdgasantrieb

ECO FUEL



Legende

	Airbag		Karosserie-Verstärkung		Steuergerät		Gastank
					12V-Batterie		Sicherheits-ventil
	Gurtstraffer		Gasdruck-dämpfer		Kraftstoff-tank		



Caddy

(Kombi EcoFuel, ab 2006)



Hinweise zur Erdgasanlage

Gastanks manuell absperren (bei Gasgeruch bzw. Austritt von Erdgas)

1. Zugang zu den Erdgastanks

- Der Zugang zu den Tanks erfolgt vom Unterboden aus.
- Die Gastanks sind durch eine Kunststoffabdeckung verkleidet. Um an die Erdgastanks zu gelangen, muss diese Abdeckung mit geeigneten Mitteln entfernt werden, ohne die darunter liegenden Bauteile der Gasanlage zu beschädigen.



elektromagnetische Absperrventile an den Gastanks

2. Absperrhähne lokalisieren

- Jeder Gastank besitzt ein eigenes Flaschenventil mit einem manuellen Absperrhahn.
- Falls einsatzbedingt erforderlich muss jeder Gastank separat abgesperrt werden.

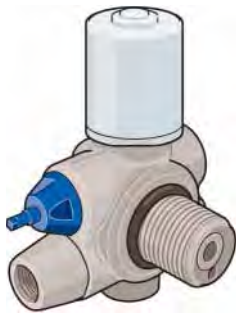

manueller Absperrhahn seitlich am Flaschenventil (bis 2008).

3. Gastank von Hand schließen

- Falls einsatzbedingt erforderlich muss jeder Gastank separat abgesperrt werden.
- Mit einem 5er-Maul- bzw. Ringschlüssel lässt sich das manuelle Absperrventil am Vierkant durch Drehen im Uhrzeigersinn bis zum Anschlag des Ventils verschließen.



manueller Absperrhahn am Fuß des Flaschenventils.







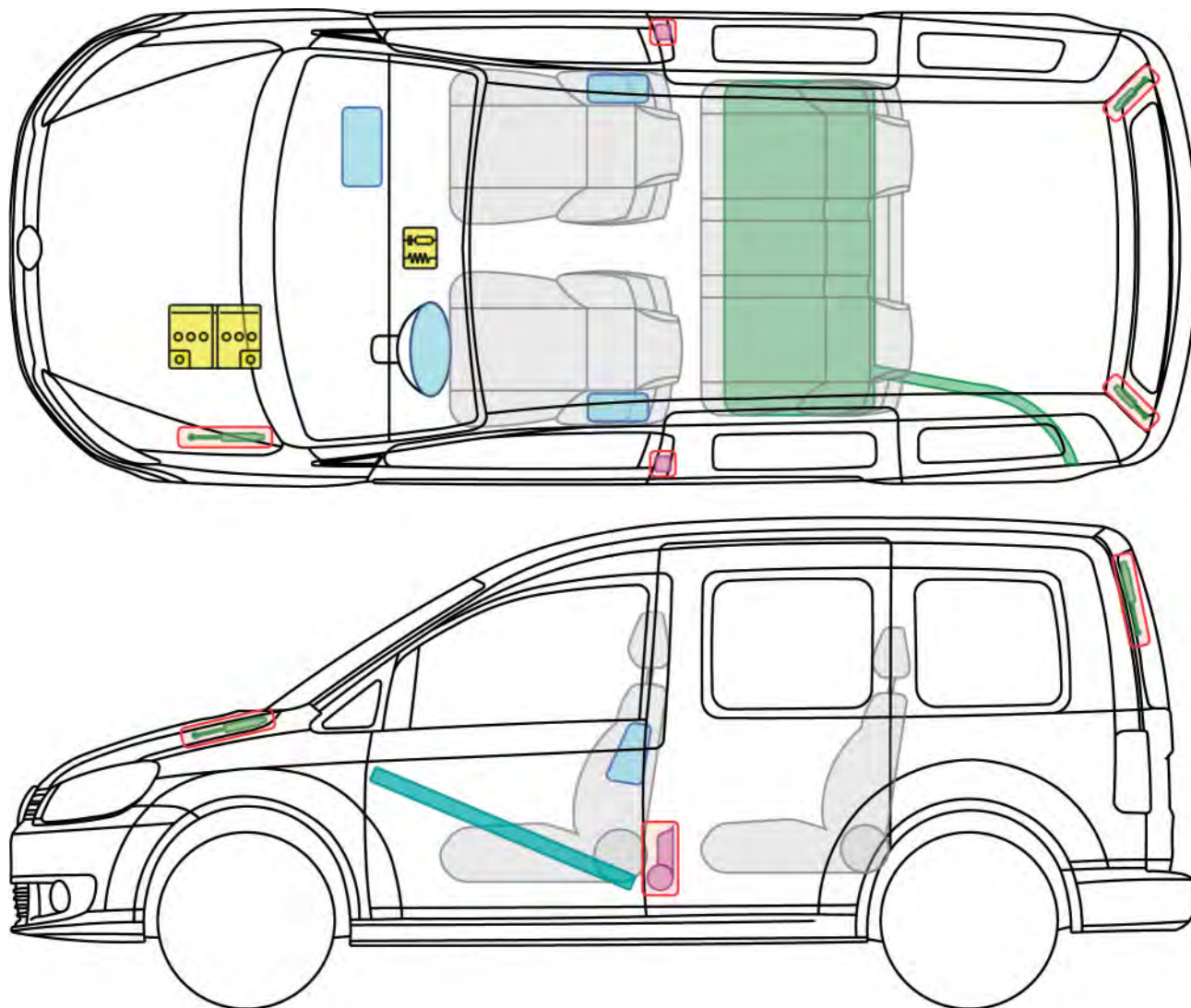

Caddy

(ab 2010)



Legende

	Airbag		Karosserie-Verstärkung		Steuergerät
					12V-Batterie
	Gurtstraffer		Gasdruck-dämpfer		Kraftstoff-tank



Caddy

(EcoFuel, ab 2010)

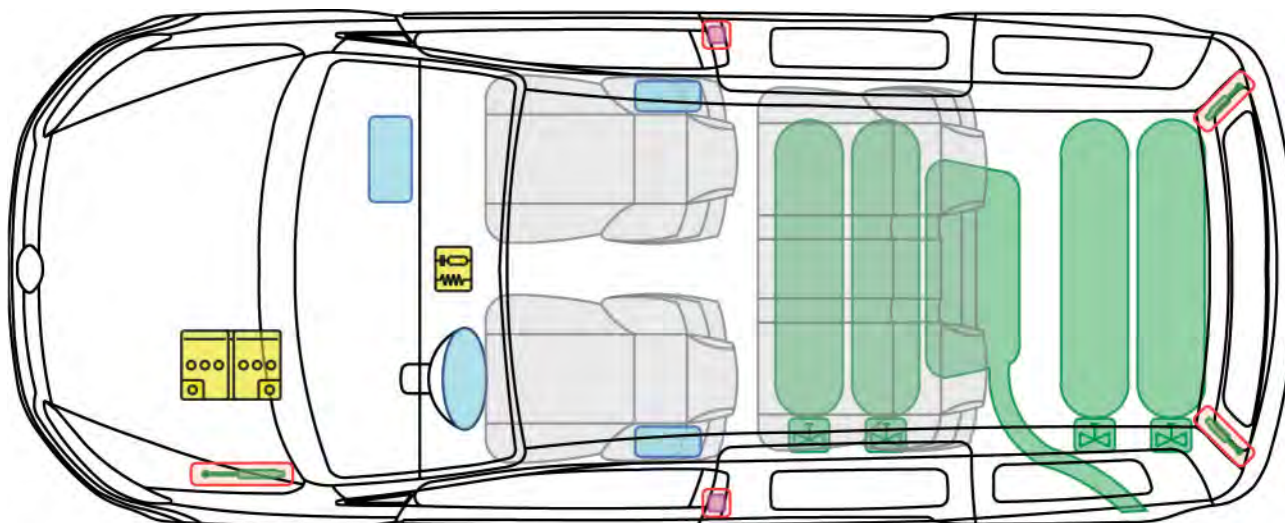





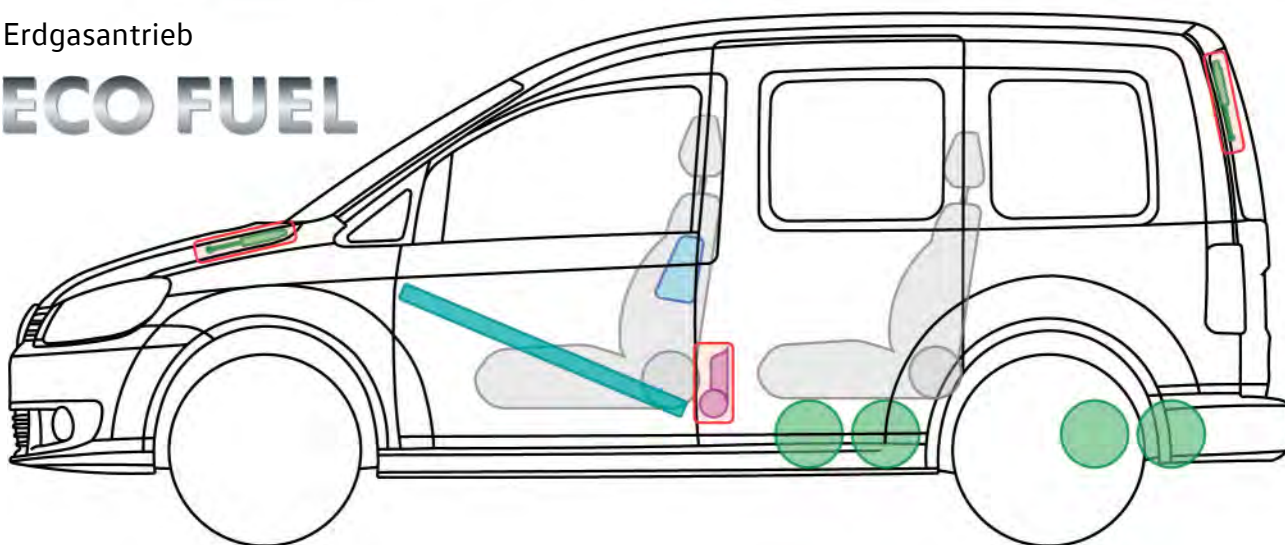



Erdgasantrieb

ECO FUEL



Legende

	Airbag		Karosserie-Verstärkung		Steuergerät		Gastank
					12V-Batterie		Sicherheits-ventil
	Gurtstraffer		Gasdruck-dämpfer		Kraftstoff-tank		



Caddy (EcoFuel, ab 2010)



Hinweise zur Erdgasanlage

Gastanks manuell absperren (bei Gasgeruch bzw. Austritt von Erdgas)

1. Zugang zu den Erdgastanks

- Der Zugang zu den Tanks erfolgt vom Unterboden aus.
- Die Gastanks sind durch eine Kunststoffabdeckung verkleidet. Um an die Erdgastanks zu gelangen, muss diese Abdeckung mit geeigneten Mitteln entfernt werden, ohne die darunter liegenden Bauteile der Gasanlage zu beschädigen.



elektromagnetische Absperrventile an den Gastanks

2. Absperrhähne lokalisieren

- Jeder Gastank besitzt ein eigenes Flaschenventil mit einem manuellen Absperrhahn.
- Falls einsatzbedingt erforderlich muss jeder Gastank separat abgesperrt werden.



manueller Absperrhahn am Fuß des Flaschenventils.

3. Gastank von Hand schließen

- Falls einsatzbedingt erforderlich muss jeder Gastank separat abgesperrt werden.
- Mit einem 5er-Maul- bzw. Ringschlüssel lässt sich das manuelle Absperrventil am Vierkant durch Drehen im Uhrzeigersinn bis zum Anschlag des Ventils verschließen.



Caddy

(Bifuel, ab 2010)

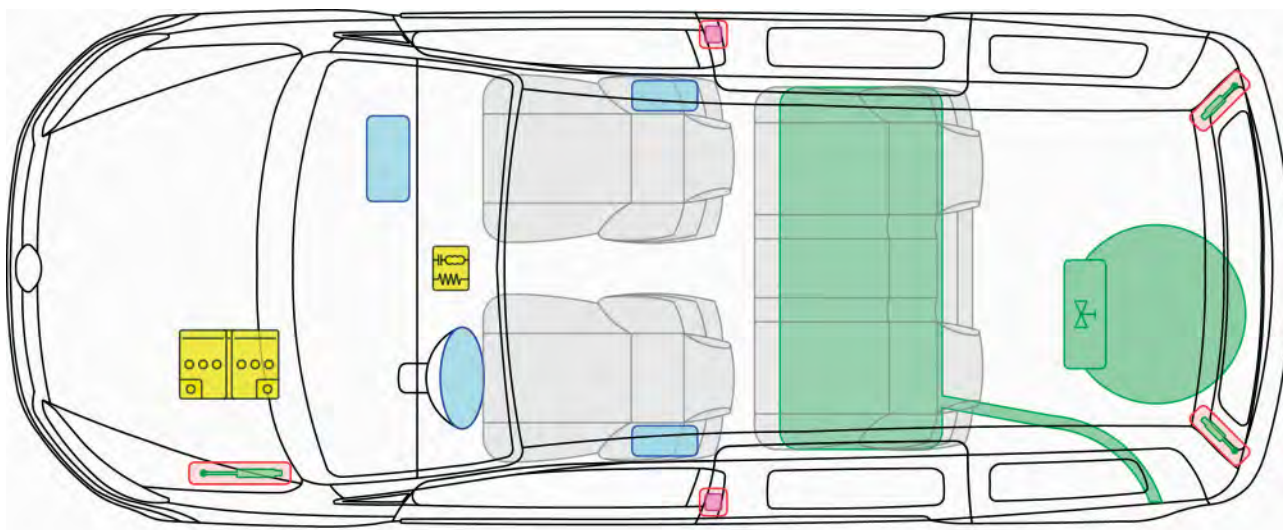





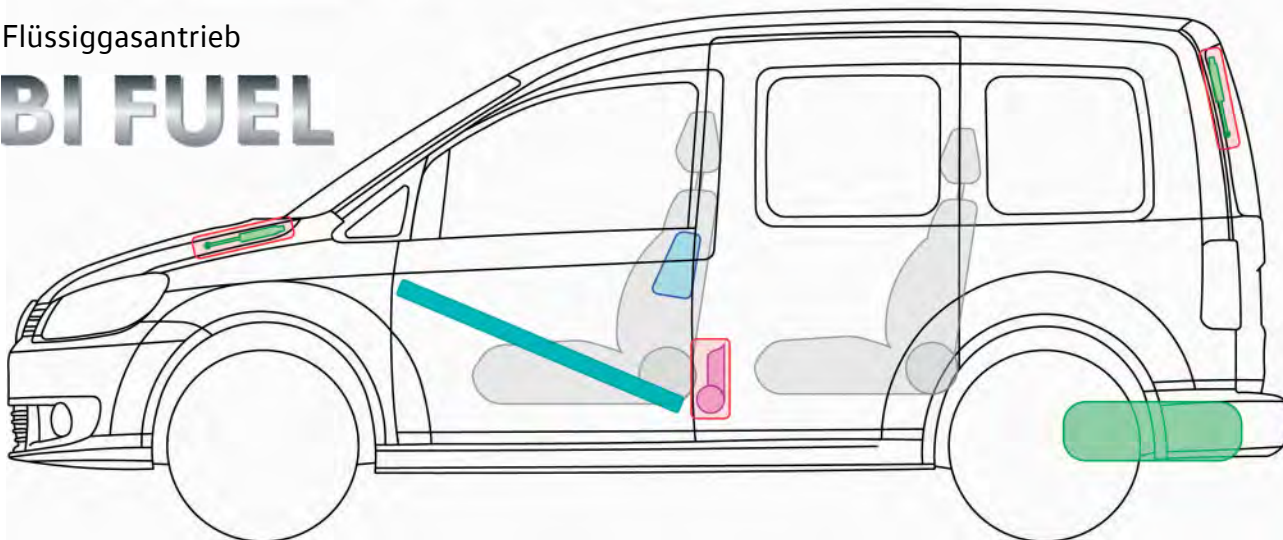



Flüssiggasantrieb

BI FUEL



Legende

	Airbag		Karosserie-Verstärkung		Steuergerät		Gastank
					12V-Batterie		Sicherheits-ventil
	Gurtstraffer		Gasdruck-dämpfer		Kraftstoff-tank		







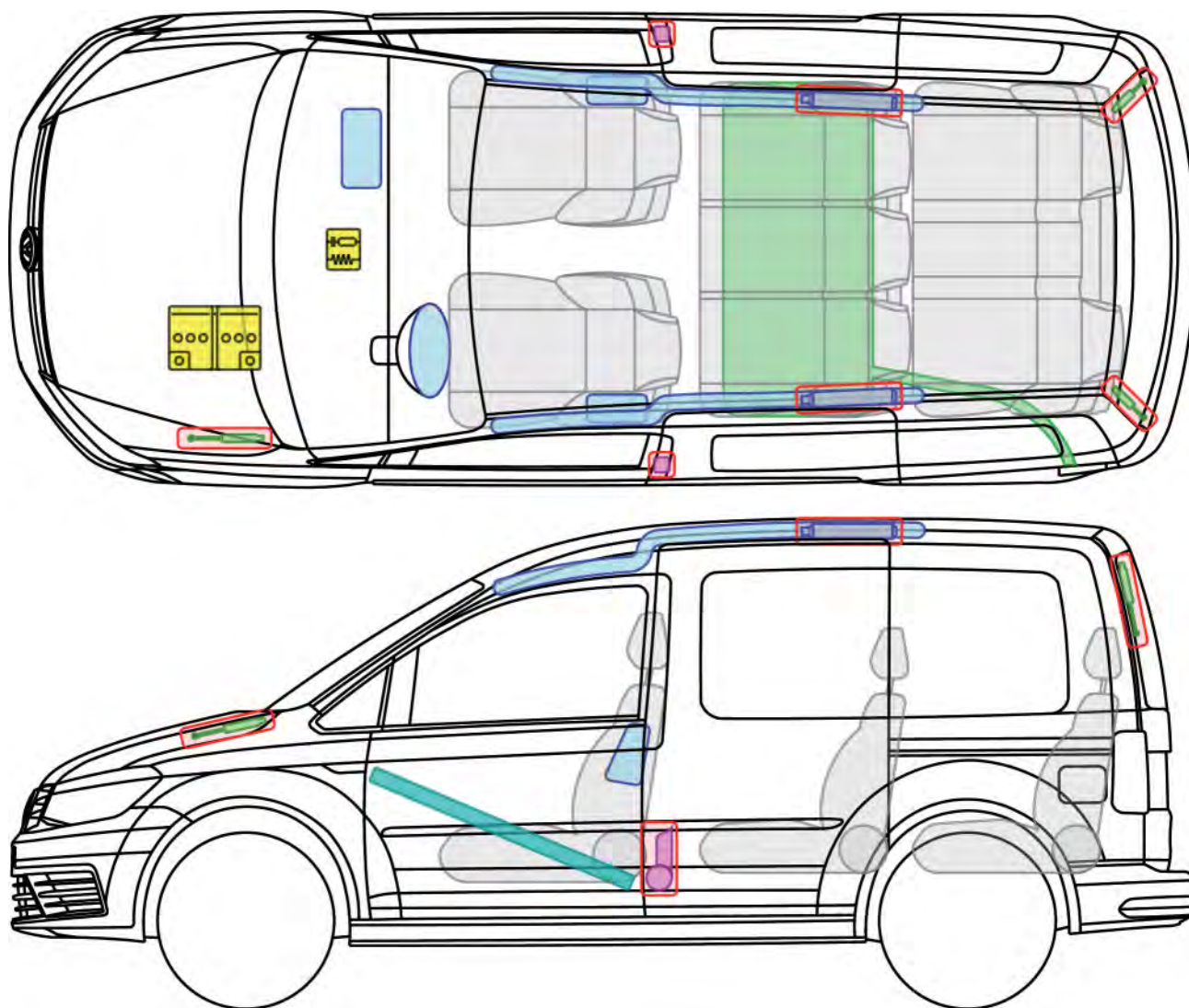



Caddy

(ab 2015)



Legende

	Airbag		Karosserie-Verstärkung		Steuergerät
	Gas-generator				12V-Batterie
	Gurtstraffer		Gasdruck-dämpfer		Kraftstoff-tank



Caddy

(EcoFuel, ab 2015)

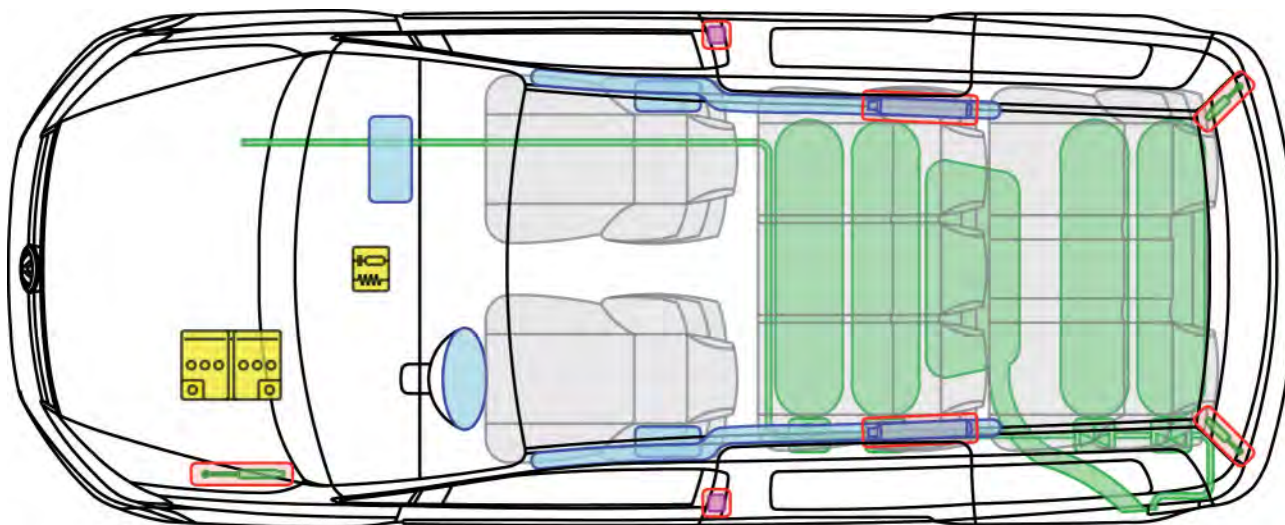





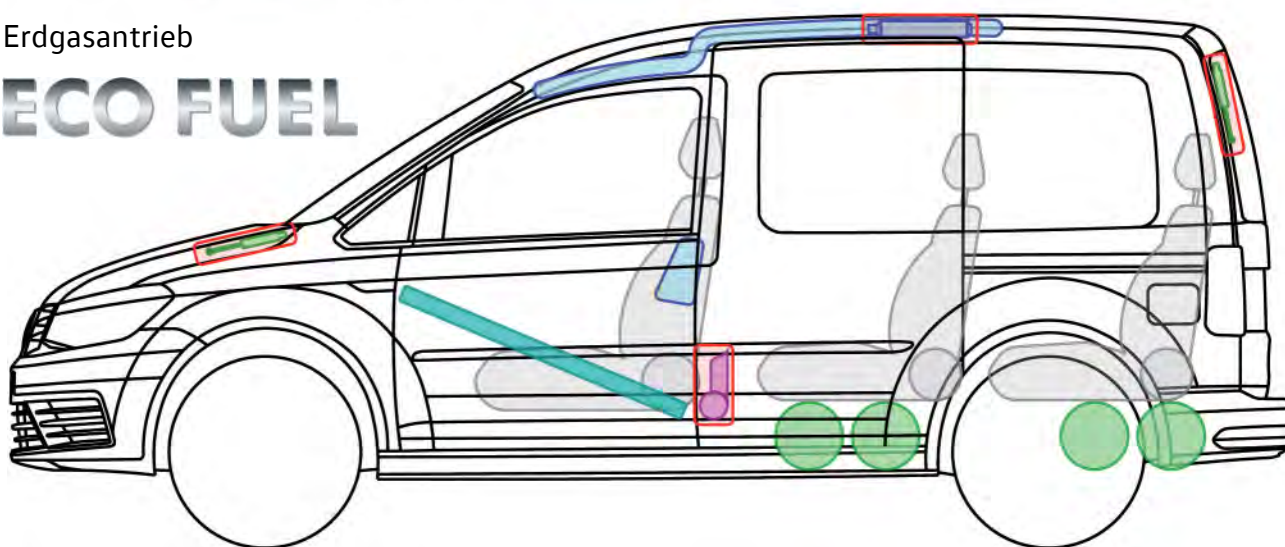





Erdgasantrieb

ECO FUEL



Legende

	Airbag		Karosserie-Verstärkung		Steuergerät		Gastank
	Gas-generator				12V-Batterie		Sicherheits-ventil
	Gurtstraffer		Gasdruck-dämpfer		Kraftstoff-tank		



Hinweise zur Erdgasanlage

Gastanks manuell absperren (bei Gasgeruch bzw. Austritt von Erdgas)

1. Zugang zu den Erdgastanks

- Der Zugang zu den Tanks erfolgt vom Unterboden aus.
- Die Gastanks sind durch eine Kunststoffabdeckung verkleidet. Um an die Erdgastanks zu gelangen, muss diese Abdeckung mit geeigneten Mitteln entfernt werden, ohne die darunter liegenden Bauteile der Gasanlage zu beschädigen.



elektromagnetische Absperrventile an den Gastanks

2. Absperrhähne lokalisieren

- Jeder Gastank besitzt ein eigenes Flaschenventil mit einem manuellen Absperrhahn.
- Falls einsatzbedingt erforderlich muss jeder Gastank separat abgesperrt werden.



manueller Absperrhahn am Fuß des Flaschenventils.

3. Gastank von Hand schließen

- Falls einsatzbedingt erforderlich muss jeder Gastank separat abgesperrt werden.
- Mit einem 5er-Maul- bzw. Ringschlüssel lässt sich das manuelle Absperrventil am Vierkant durch Drehen im Uhrzeigersinn bis zum Anschlag des Ventils verschließen.







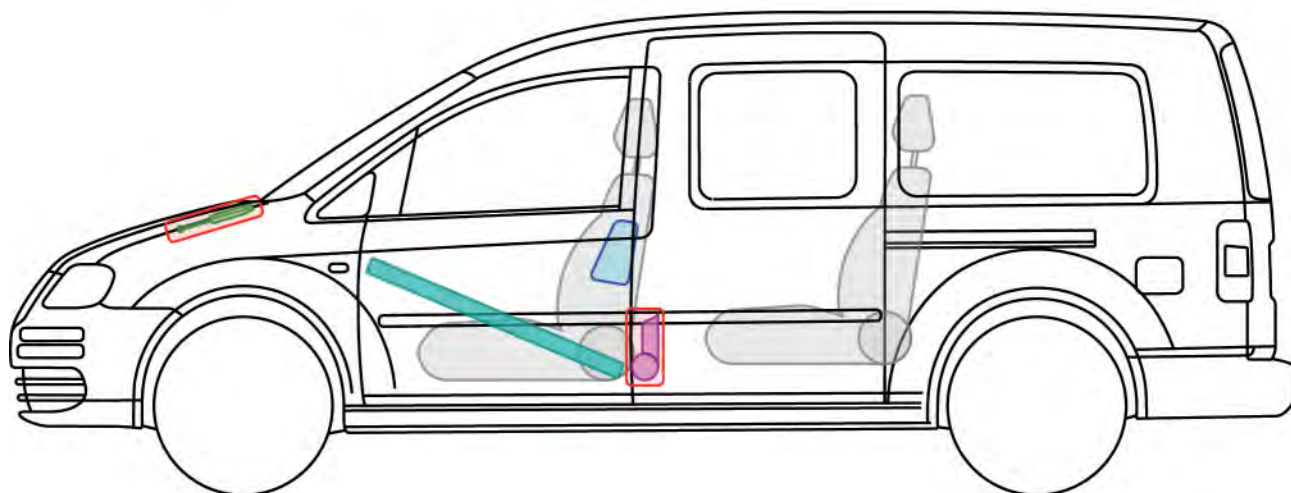
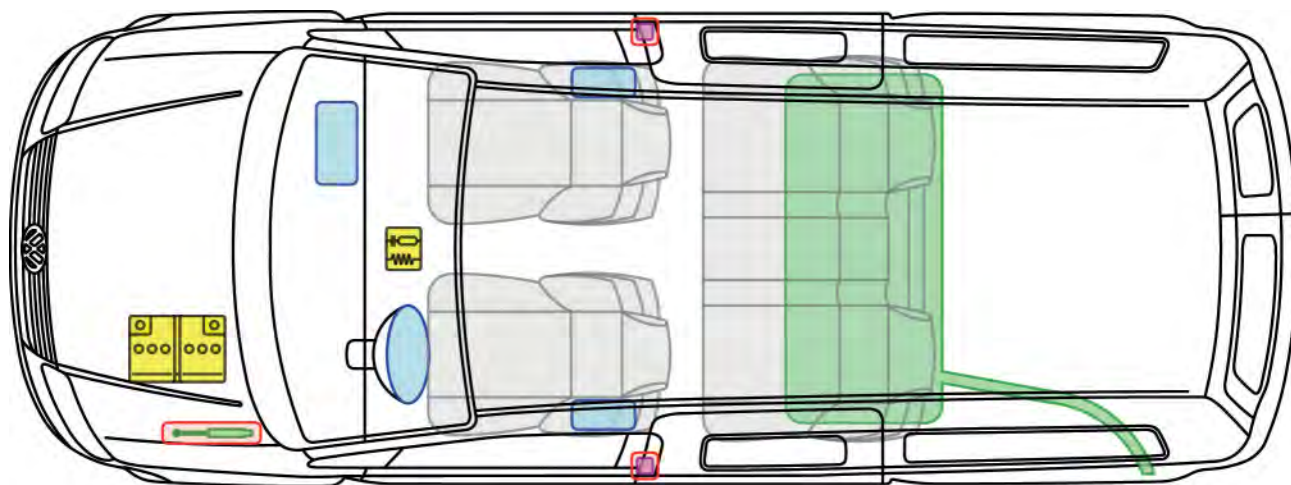

Caddy Maxi

(ab 2007)



Legende

	Airbag		Karosserie-Verstärkung		Steuergerät
					12V-Batterie
	Gurtstraffer		Gasdruck-dämpfer		Kraftstoff-tank



Caddy Maxi

(EcoFuel, ab 2007)

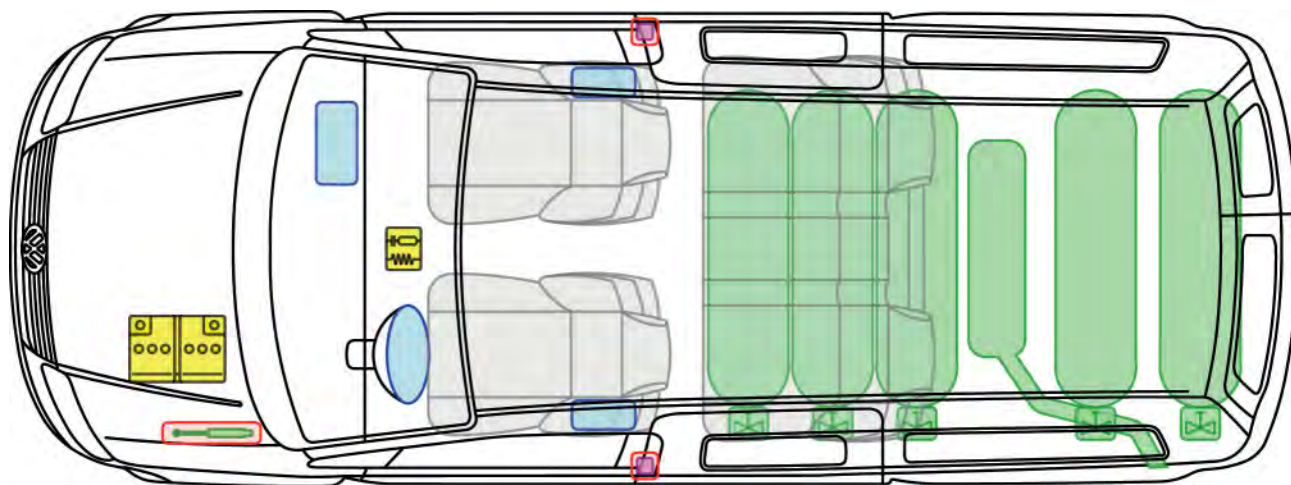





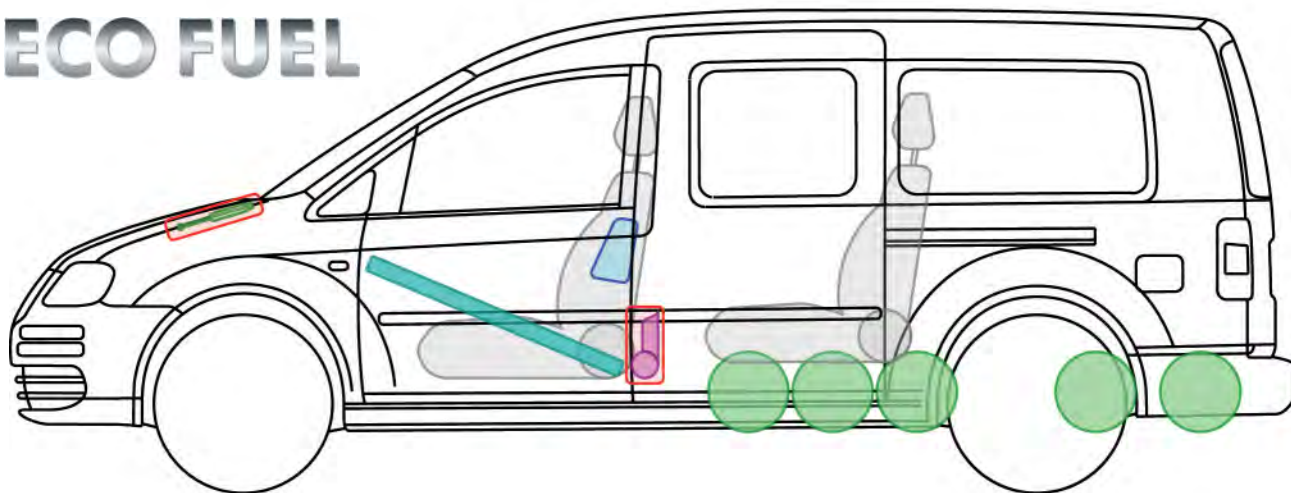



Erdgasantrieb

ECO FUEL

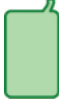

Legende

	Airbag		Karosserie-Verstärkung		Steuergerät		Gastank
					12V-Batterie		Sicherheits-ventil
	Gurtstraffer		Gasdruck-dämpfer		Kraftstoff-tank		



Hinweise zur Erdgasanlage

Gastanks manuell absperren (bei Gasgeruch bzw. Austritt von Erdgas)

1. Zugang zu den Erdgastanks

- Der Zugang zu den Tanks erfolgt vom Unterboden aus.
- Die Gastanks sind durch eine Kunststoffabdeckung verkleidet. Um an die Erdgastanks zu gelangen, muss diese Abdeckung mit geeigneten Mitteln entfernt werden, ohne die darunter liegenden Bauteile der Gasanlage zu beschädigen.



elektromagnetische Absperrventile an den Gastanks

2. Absperrhähne lokalisieren

- Jeder Gastank besitzt ein eigenes Flaschenventil mit einem manuellen Absperrhahn.
- Falls einsatzbedingt erforderlich muss jeder Gastank separat abgesperrt werden.



manueller Absperrhahn am Fuß des Flaschenventils.

3. Gastank von Hand schließen





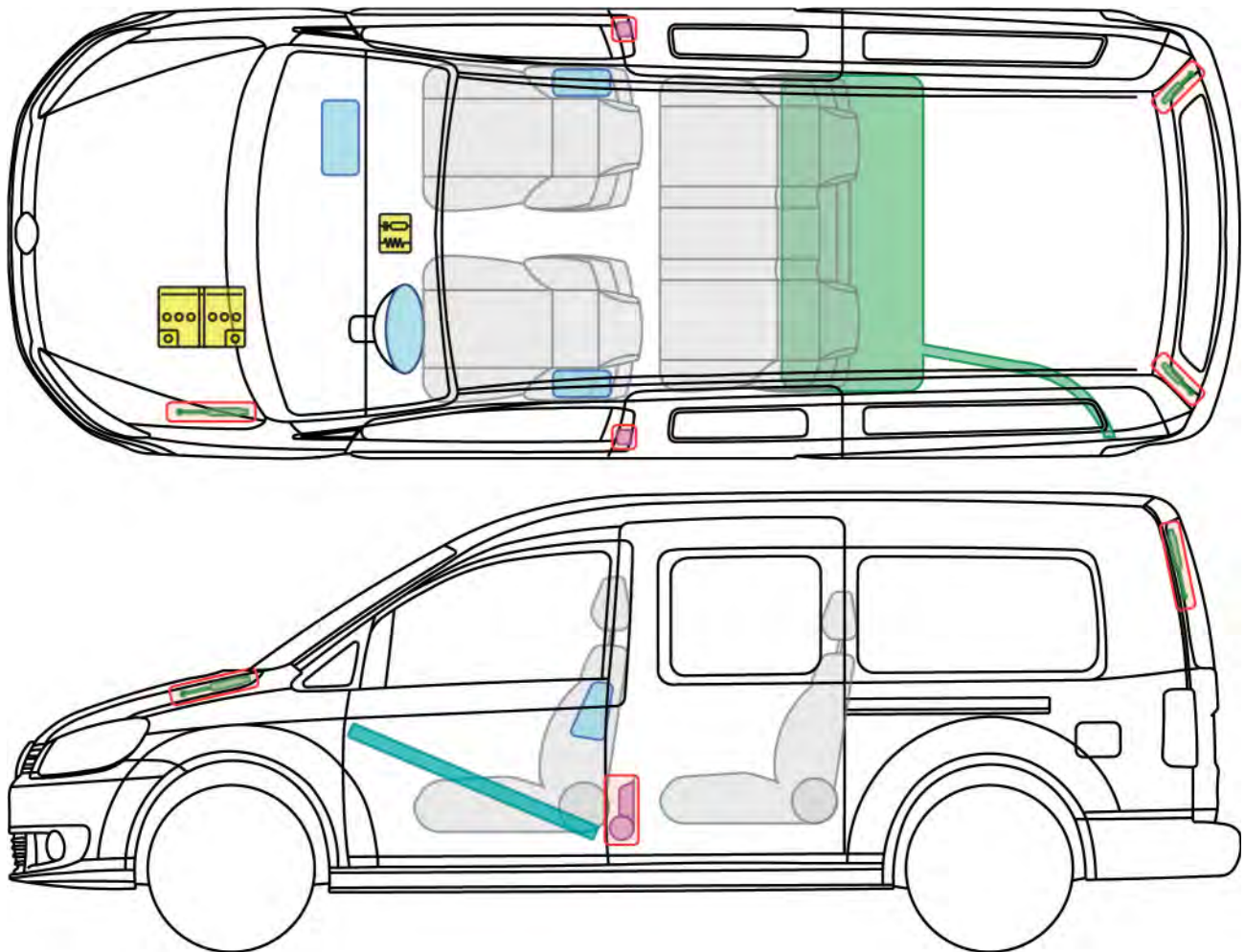

- Falls einsatzbedingt erforderlich muss jeder Gastank separat abgesperrt werden.
- Mit einem 5er-Maul- bzw. Ringschlüssel lässt sich das manuelle Absperrventil am Vierkant durch Drehen im Uhrzeigersinn bis zum Anschlag des Ventils verschließen.



Caddy Maxi (ab 2010)



Legende

	Airbag		Karosserie-Verstärkung		Steuergerät
					12V-Batterie
	Gurtstraffer		Gasdruck-dämpfer		Kraftstoff-tank



Caddy Maxi

(EcoFuel, ab 2010)

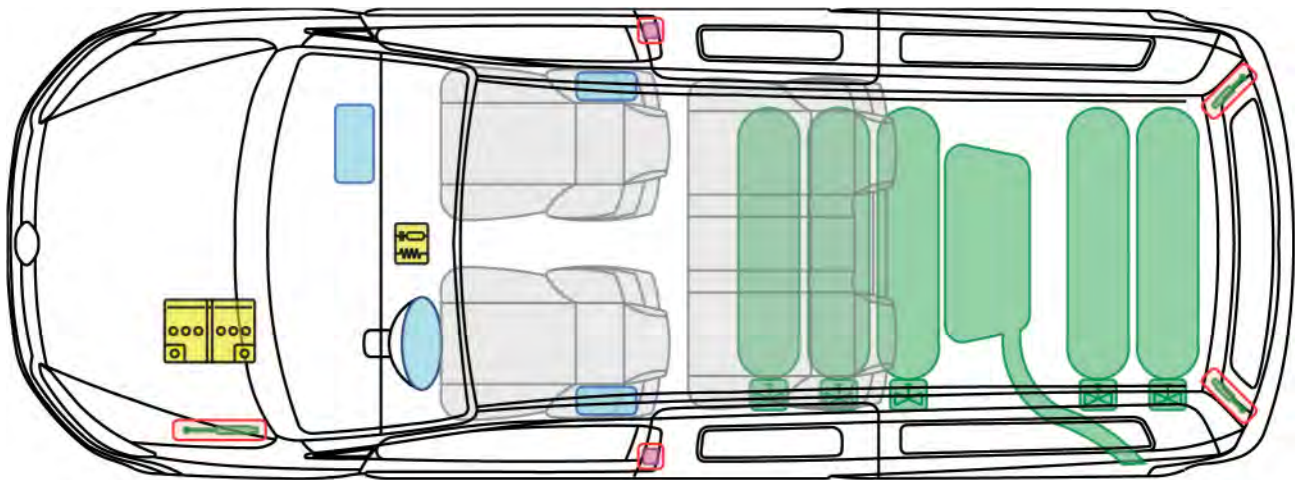





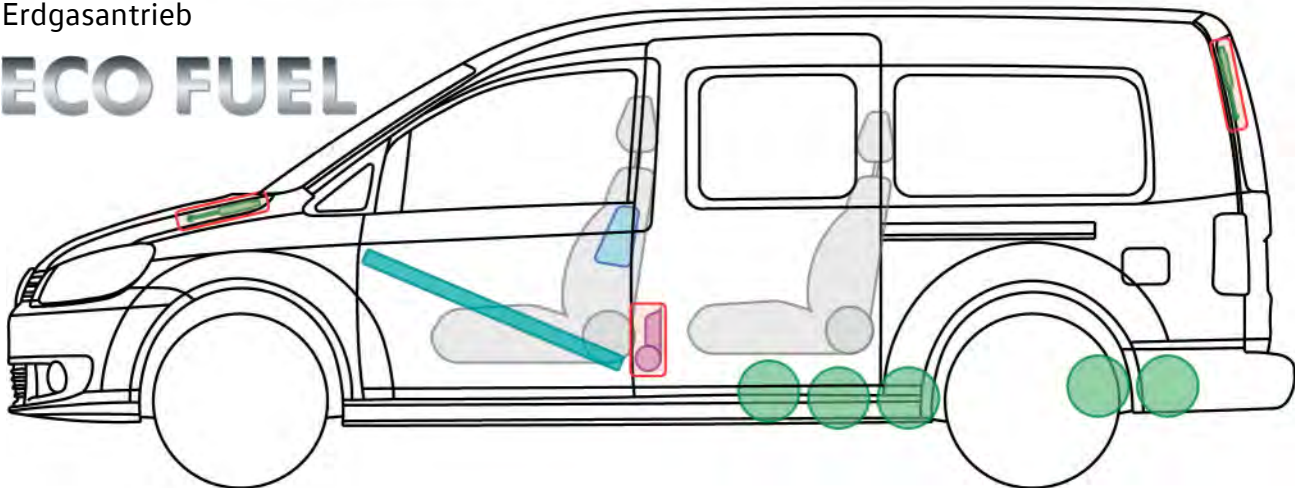



Erdgasantrieb

ECO FUEL



Legende

	Airbag		Karosserie-Verstärkung		Steuergerät		Gastank
					12V-Batterie		Sicherheits-ventil
	Gurtstraffer		Gasdruck-dämpfer		Kraftstoff-tank		



Hinweise zur Erdgasanlage

Gastanks manuell absperren (bei Gasgeruch bzw. Austritt von Erdgas)

1. Zugang zu den Erdgastanks

- Der Zugang zu den Tanks erfolgt vom Unterboden aus.
- Die Gastanks sind durch eine Kunststoffabdeckung verkleidet. Um an die Erdgastanks zu gelangen, muss diese Abdeckung mit geeigneten Mitteln entfernt werden, ohne die darunter liegenden Bauteile der Gasanlage zu beschädigen.



elektromagnetische Absperrventile an den Gastanks

2. Absperrhähne lokalisieren

- Jeder Gastank besitzt ein eigenes Flaschenventil mit einem manuellen Absperrhahn.
- Falls einsatzbedingt erforderlich muss jeder Gastank separat abgesperrt werden.



manueller Absperrhahn am Fuß des Flaschenventils.

3. Gastank von Hand schließen

- Falls einsatzbedingt erforderlich muss jeder Gastank separat abgesperrt werden.
- Mit einem 5er-Maul- bzw. Ringschlüssel lässt sich das manuelle Absperrventil am Vierkant durch Drehen im Uhrzeigersinn bis zum Anschlag des Ventils verschließen.



Caddy Maxi

(Bifuel, ab 2010)

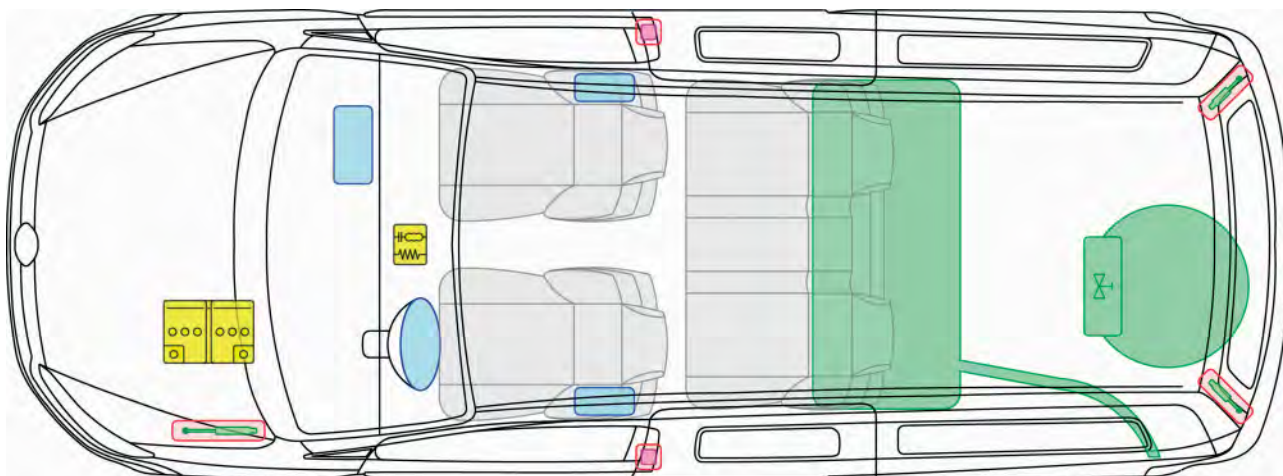





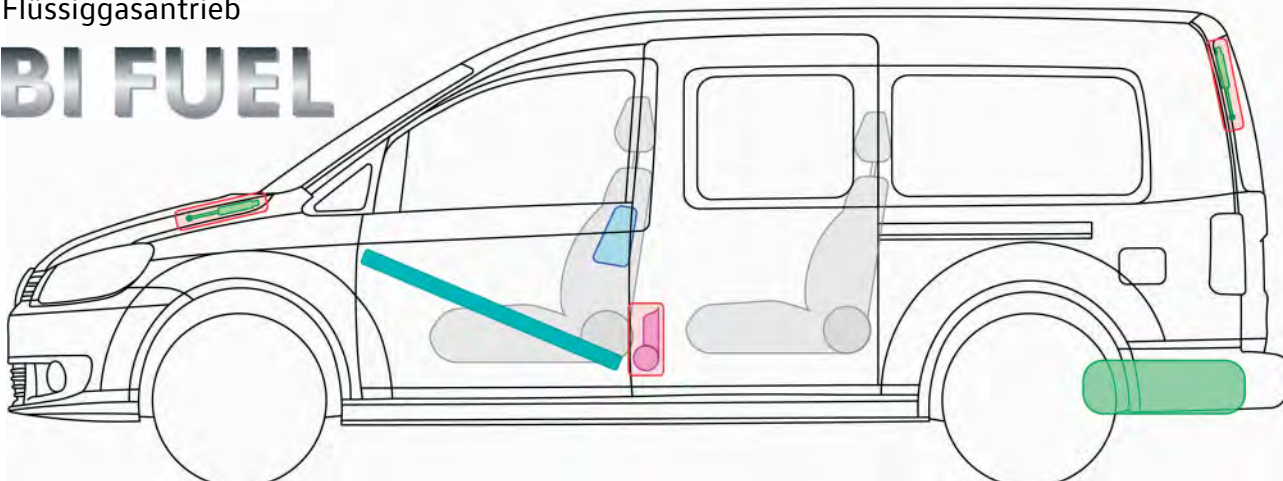



Flüssiggasantrieb

BI FUEL



Legende

	Airbag		Karosserie-Verstärkung		Steuergerät		Gastank
					12V-Batterie		Sicherheits-ventil
	Gurtstraffer		Gasdruck-dämpfer		Kraftstoff-tank		







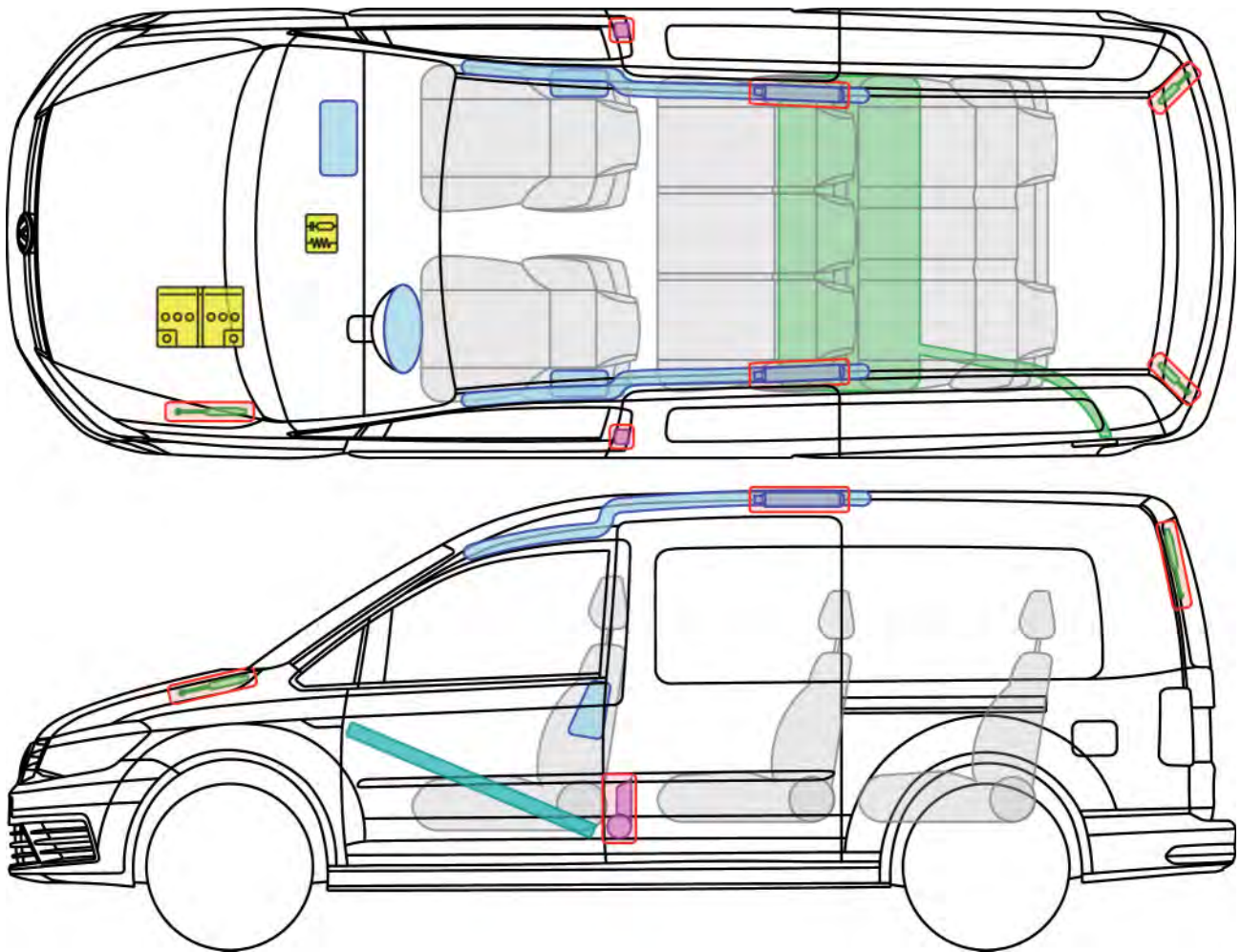



Caddy Maxi

(ab 2015)



Legende

	Airbag		Karosserie-Verstärkung		Steuergerät	
	Gas-generator				12V-Batterie	
	Gurtstraffer		Gasdruck-dämpfer		Kraftstoff-tank	



Caddy Maxi

(EcoFuel, ab 2015)

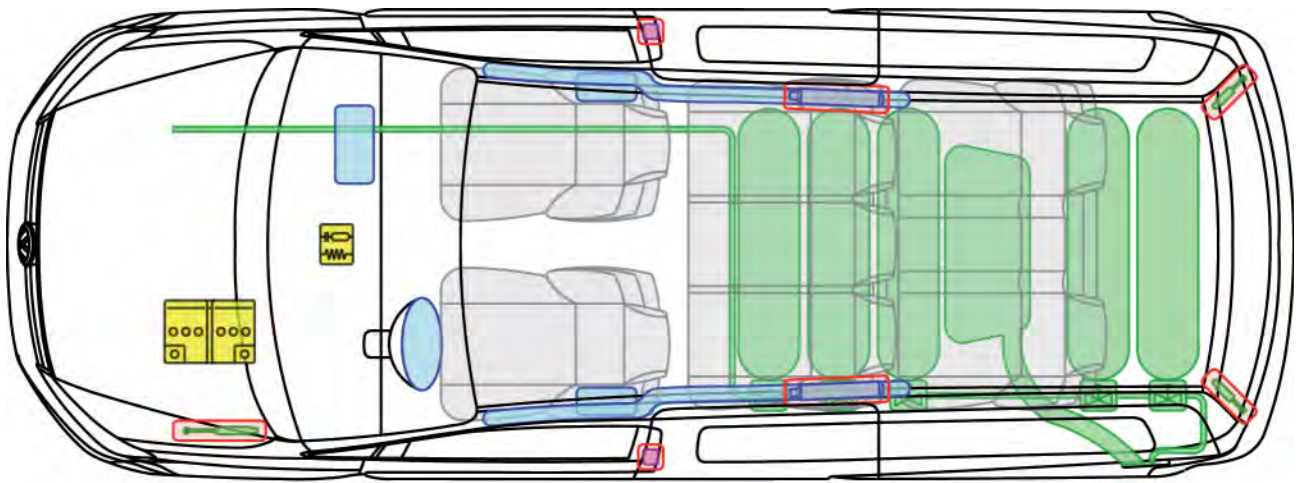





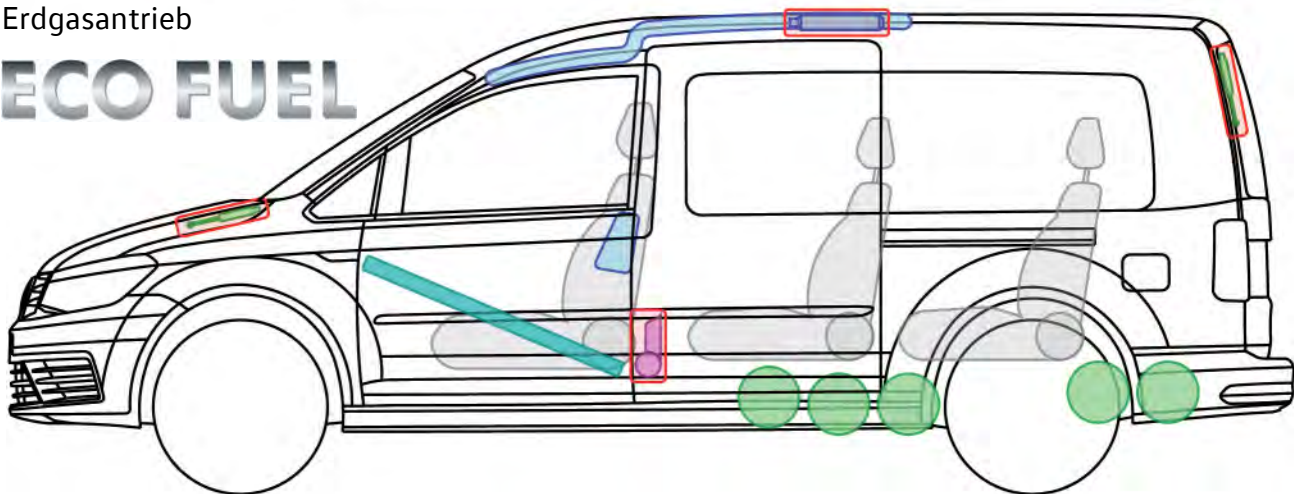





Erdgasantrieb

ECO FUEL



Legende

	Airbag		Karosserie-Verstärkung		Steuergerät		Gastank
	Gas-generator				12V-Batterie		Sicherheits-ventil
	Gurtstraffer		Gasdruck-dämpfer		Kraftstoff-tank		



Hinweise zur Erdgasanlage

Gastanks manuell absperren (bei Gasgeruch bzw. Austritt von Erdgas)

1. Zugang zu den Erdgastanks

- Der Zugang zu den Tanks erfolgt vom Unterboden aus.
- Die Gastanks sind durch eine Kunststoffabdeckung verkleidet. Um an die Erdgastanks zu gelangen, muss diese Abdeckung mit geeigneten Mitteln entfernt werden, ohne die darunter liegenden Bauteile der Gasanlage zu beschädigen.



elektromagnetische Absperrventile an den Gastanks

2. Absperrhähne lokalisieren

- Jeder Gastank besitzt ein eigenes Flaschenventil mit einem manuellen Absperrhahn.
- Falls einsatzbedingt erforderlich muss jeder Gastank separat abgesperrt werden.



manueller Absperrhahn am Fuß des Flaschenventils.

3. Gastank von Hand schließen

- Falls einsatzbedingt erforderlich muss jeder Gastank separat abgesperrt werden.
- Mit einem 5er-Maul- bzw. Ringschlüssel lässt sich das manuelle Absperrventil am Vierkant durch Drehen im Uhrzeigersinn bis zum Anschlag des Ventils verschließen.







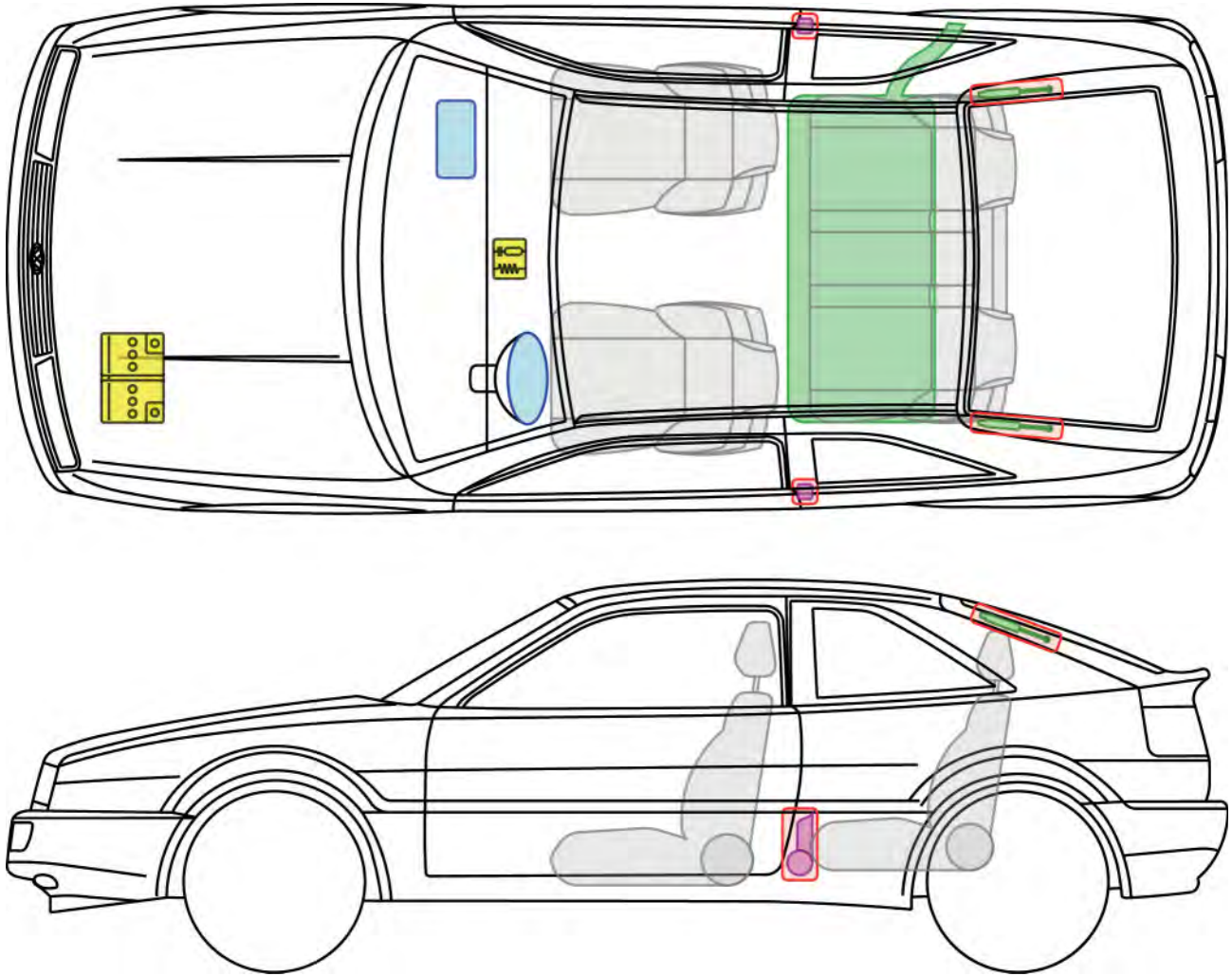

Corrado

(ab 1988)



Legende

	Airbag		Karosserie-Verstärkung		Steuergerät
					12V-Batterie
	Gurtstraffer		Gasdruck-dämpfer		Kraftstoff-tank



Crafter



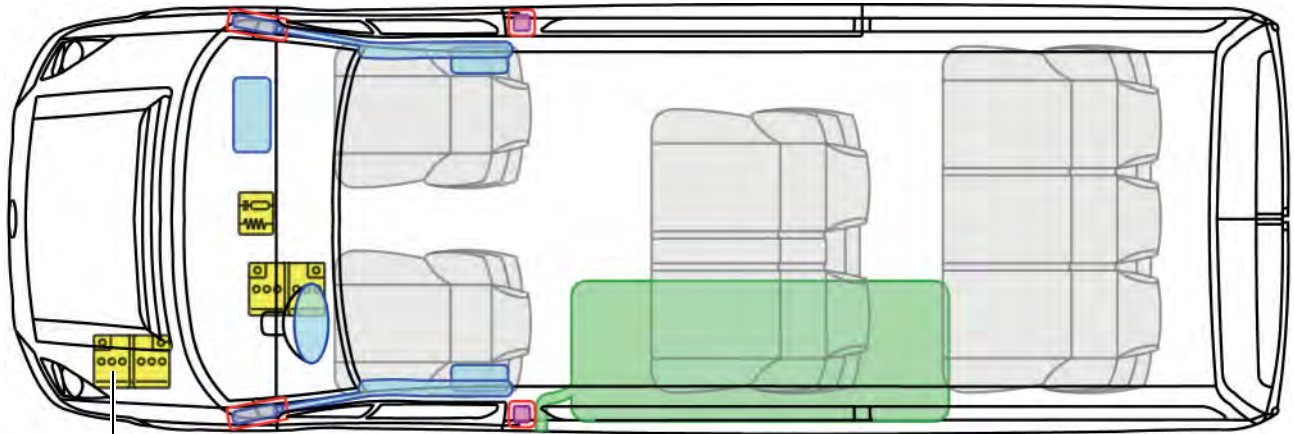



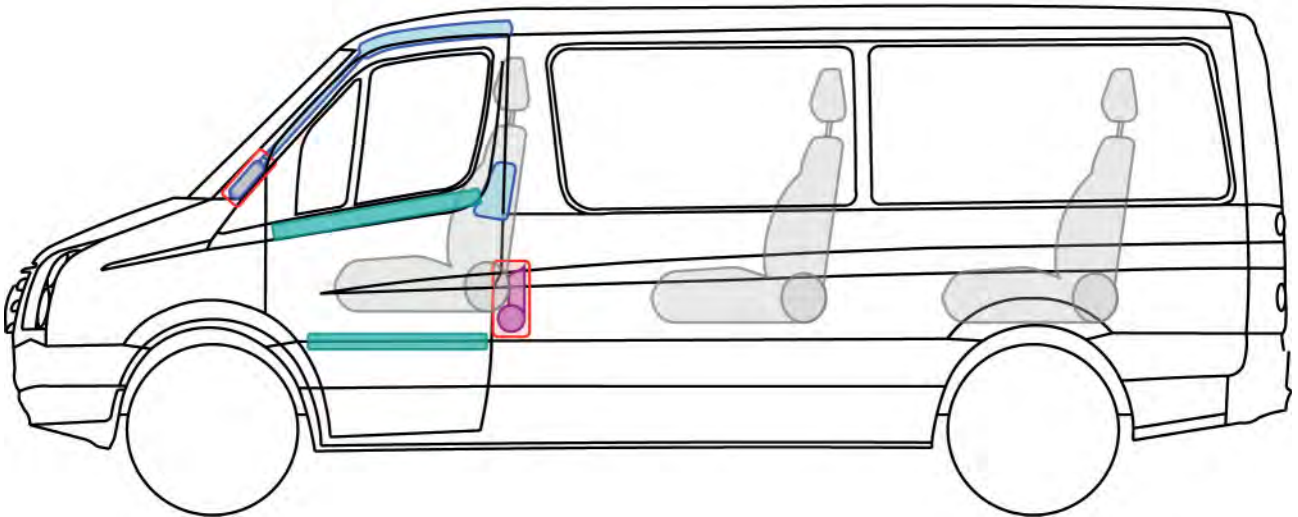

(ab 2006)



ausstattungsabhängig 2. Batterie im Motorraum



Legende

	Airbag		Karosserie-Verstärkung		Steuergerät
	Gas-generator				12V-Batterie
	Gurtstraffer		Gasdruck-dämpfer		Kraftstoff-tank



Fahrzeug deaktivieren

Batterie abklemmen

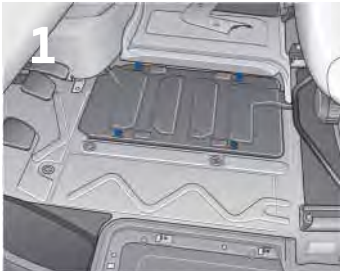

1. Batterieabdeckung im Fußraum vor dem Fahrersitz lokalisieren

- Bodenbelag entfernen
- 4 Verschraubungen lösen und Abdeckung abnehmen



2. Masseanschluss (-) an der Batterie abklemmen



Optionale Methode: Masseanschlusstecker (Sonderausstattung) entriegeln

- Masseanschlusstecker an der Spritzwand neben dem Gaspedal lokalisieren
- Stecker mit geeignetem Werkzeug entriegeln und abziehen



Crafter Fahrgestell

(2-Türer, ab 2006)

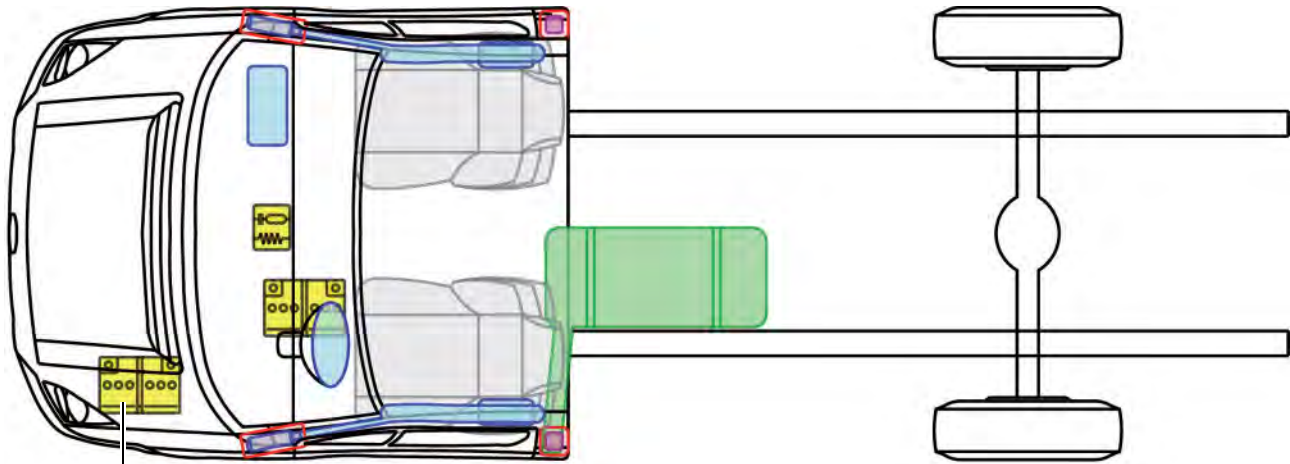



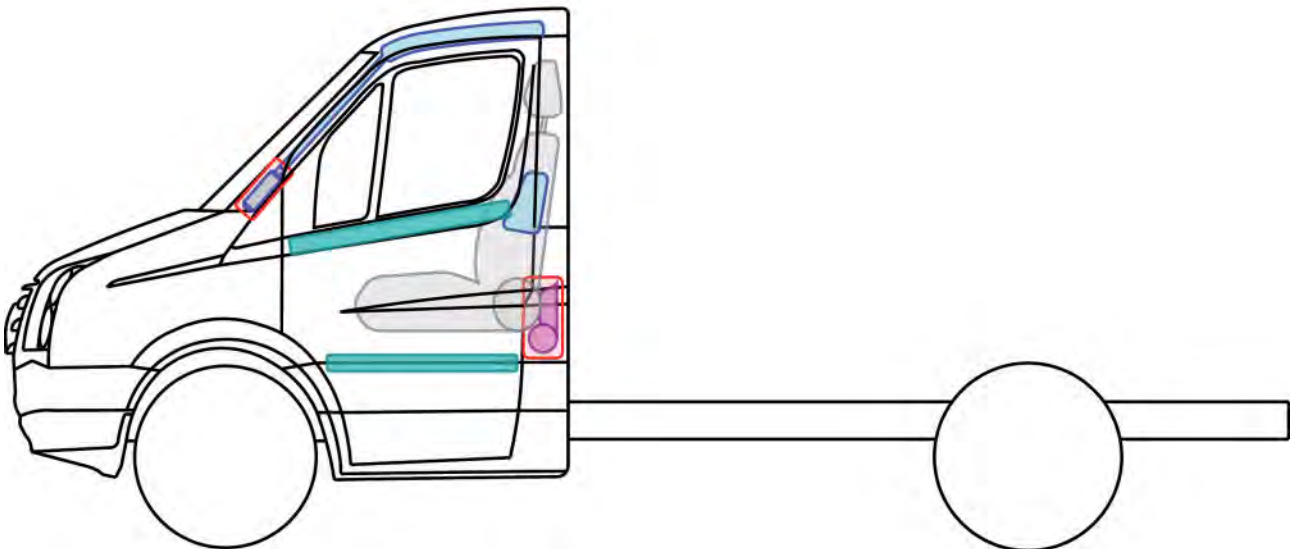



ausstattungsabhängig 2. Batterie im Motorraum



Die Sicherheitsausstattung ist für alle Dachhöhen und Radstände einheitlich ausgeführt.

Legende

	Airbag		Karosserie-Verstärkung		Steuergerät	
	Gas-generator				12V-Batterie	
	Gurtstraffer				Kraftstoff-tank	



Crafter Fahrgestell

(2-Türer, ab 2006)



Fahrzeug deaktivieren

Batterie abklemmen

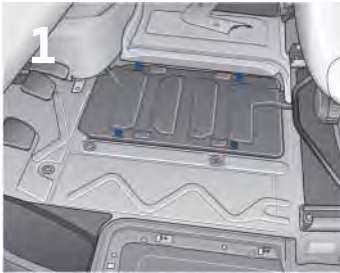

1. Batterieabdeckung im Fußraum vor dem Fahrersitz lokalisieren

- Bodenbelag entfernen
- 4 Verschraubungen lösen und Abdeckung abnehmen



2. Masseanschluss (-) an der Batterie abklemmen







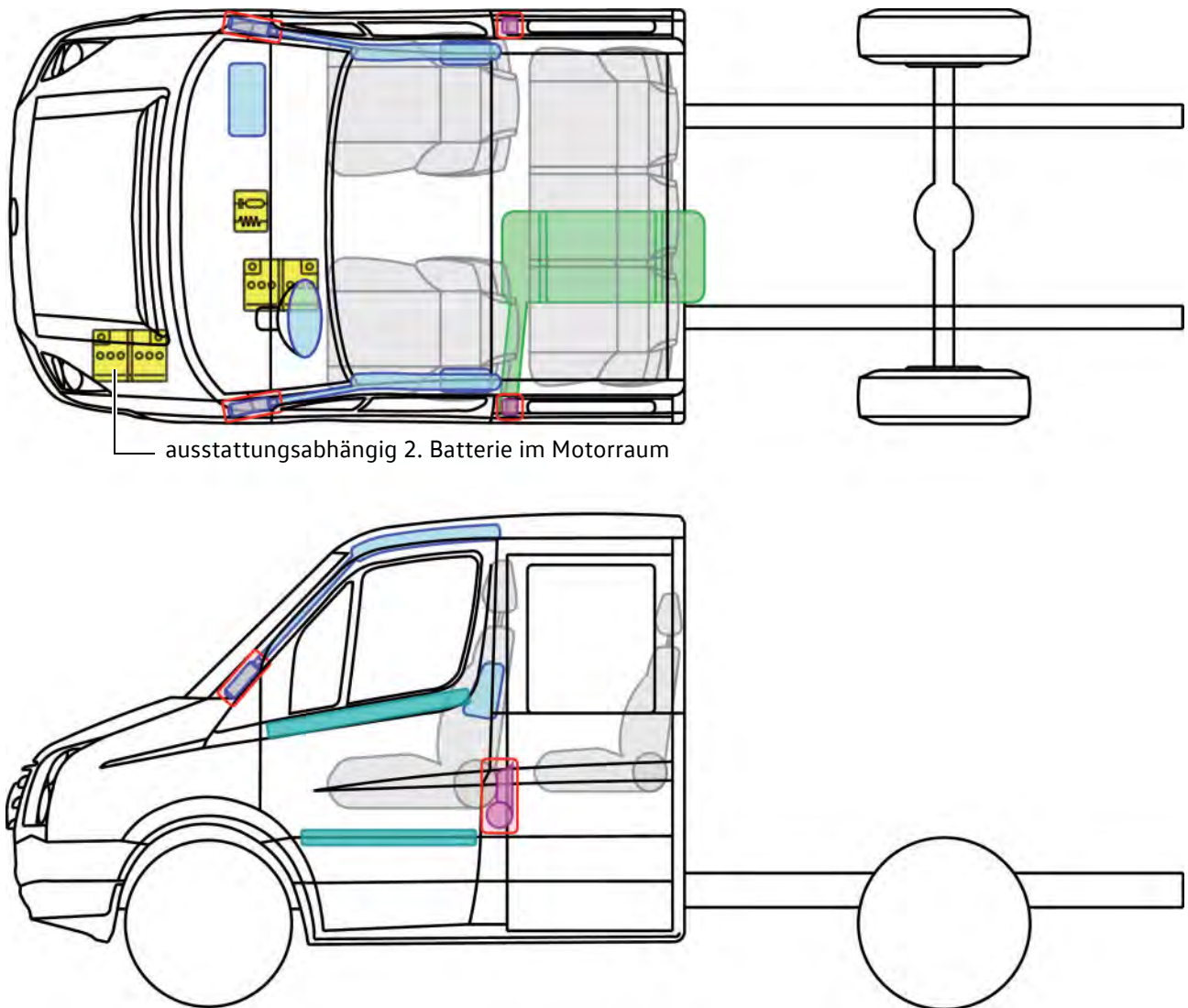

Crafter Fahrgestell

(4-Türer, ab 2006)



Legende

	Airbag		Karosserie-Verstärkung		Steuergerät	
	Gas-generator				12V-Batterie	
	Gurtstraffer				Kraftstoff-tank	



Crafter Fahrgestell

(4-Türer, ab 2006)



Fahrzeug deaktivieren

Batterie abklemmen

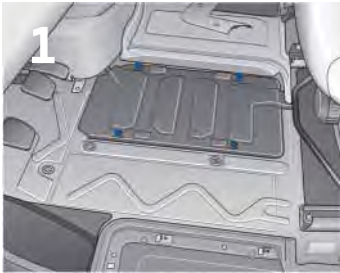

1. Batterieabdeckung im Fußraum vor dem Fahrersitz lokalisieren

- Bodenbelag entfernen
- 4 Verschraubungen lösen und Abdeckung abnehmen



2. Masseanschluss (-) an der Batterie abklemmen



Optionale Methode: Masseanschlusstecker (Sonderausstattung) entriegeln

- Masseanschlusstecker an der Spritzwand neben dem Gaspedal lokalisieren
- Stecker mit geeignetem Werkzeug entriegeln und abziehen

C



Crafter

(ab 2017)

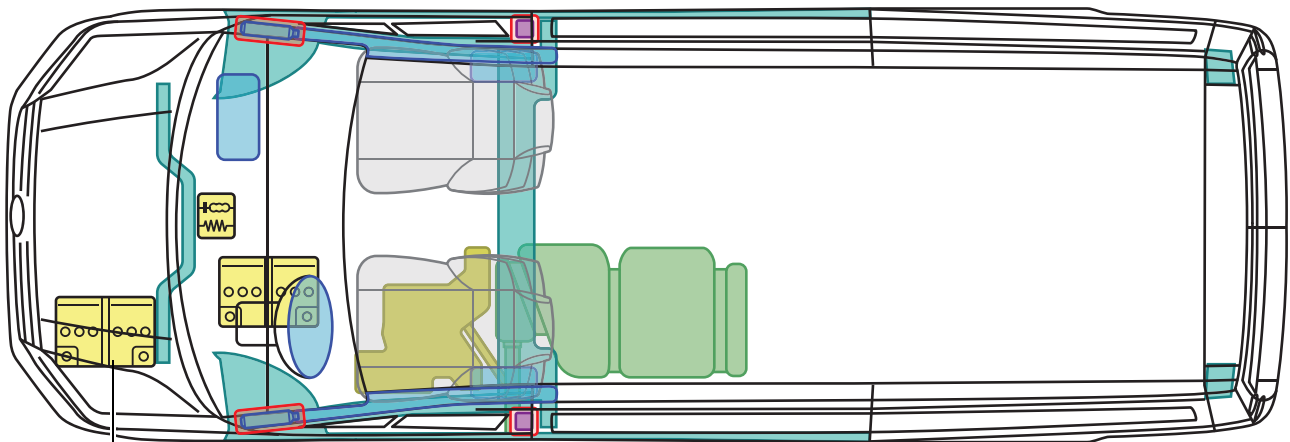



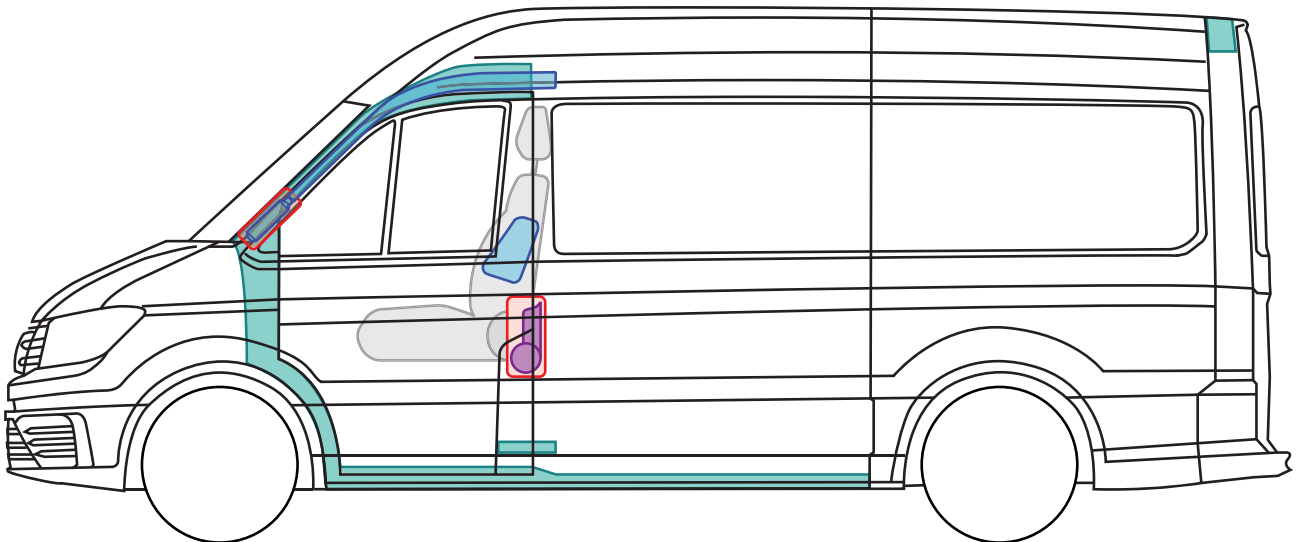





ausstattungsabhängig 2. Batterie im Motorraum



Die Sicherheitsausstattung ist für alle Dachhöhen und Radstände einheitlich ausgeführt.

Legende

	Airbag		Karosserie-Verstärkung		Steuergerät		
	Gas-generator				12V-Batterie		
	Gurtstraffer		Gasdruck-dämpfer		Kraftstoff-tank		SCR-Tank



Fahrzeug deaktivieren

Batterie abklemmen

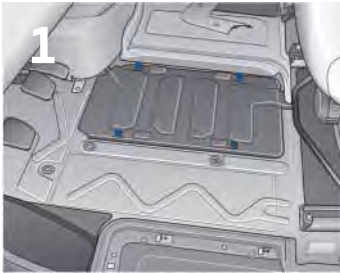

1. Batterieabdeckung im Fußraum vor dem Fahrersitz lokalisieren

- Bodenbelag entfernen
- 4 Verschraubungen lösen und Abdeckung abnehmen



2. Masseanschluss (-) an der Batterie abklemmen



Crafter Fahrgestell



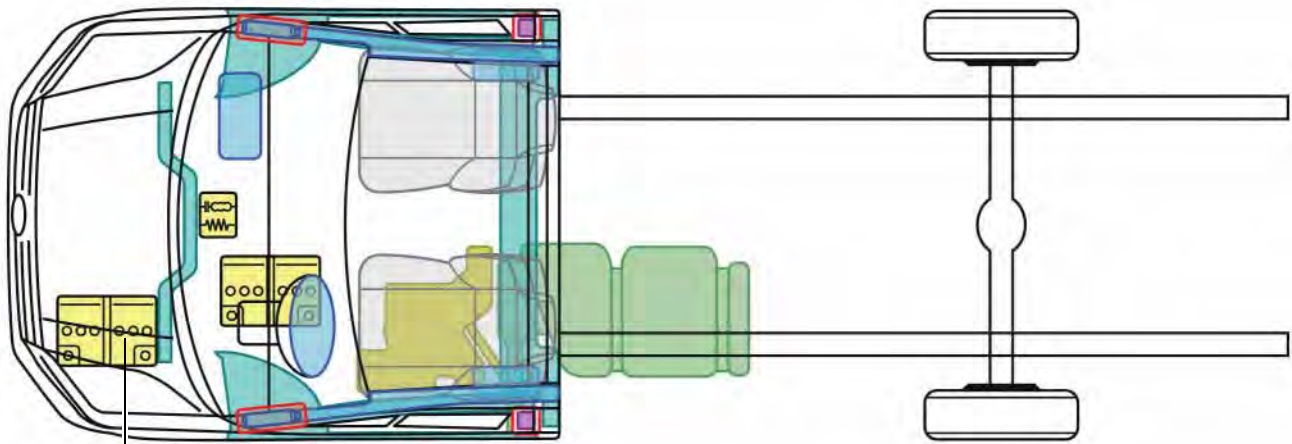



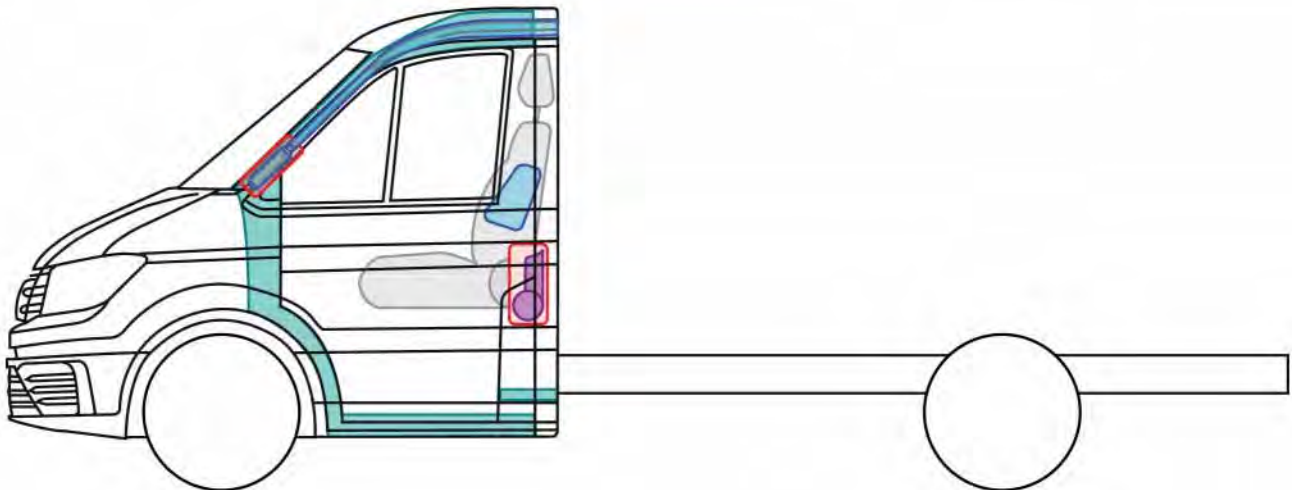

(2-Türer, ab 2017)



ausstattungsabhängig 2. Batterie im Motorraum



Legende

	Airbag		Karosserie-Verstärkung		Steuergerät		
	Gas-generator				12V-Batterie		
	Gurtstraffer				Kraftstoff-tank		SCR-Tank



Fahrzeug deaktivieren

Batterie abklemmen

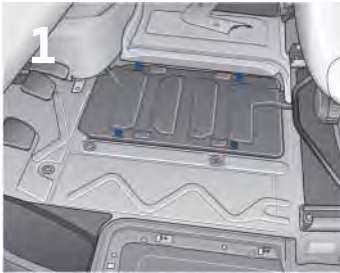

1. Batterieabdeckung im Fußraum vor dem Fahrersitz lokalisieren

- Bodenbelag entfernen
- 4 Verschraubungen lösen und Abdeckung abnehmen



2. Masseanschluss (-) an der Batterie abklemmen



Optionale Methode: Masseanschlusstecker (Sonderausstattung) entriegeln

- Masseanschlusstecker an der Spritzwand neben dem Gaspedal lokalisieren
- Stecker mit geeignetem Werkzeug entriegeln und abziehen







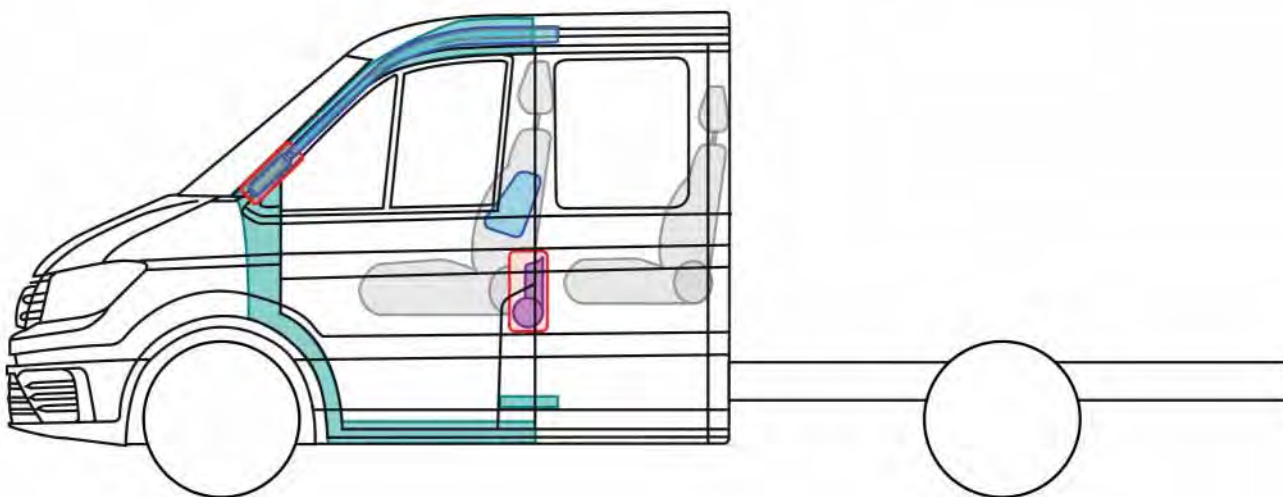
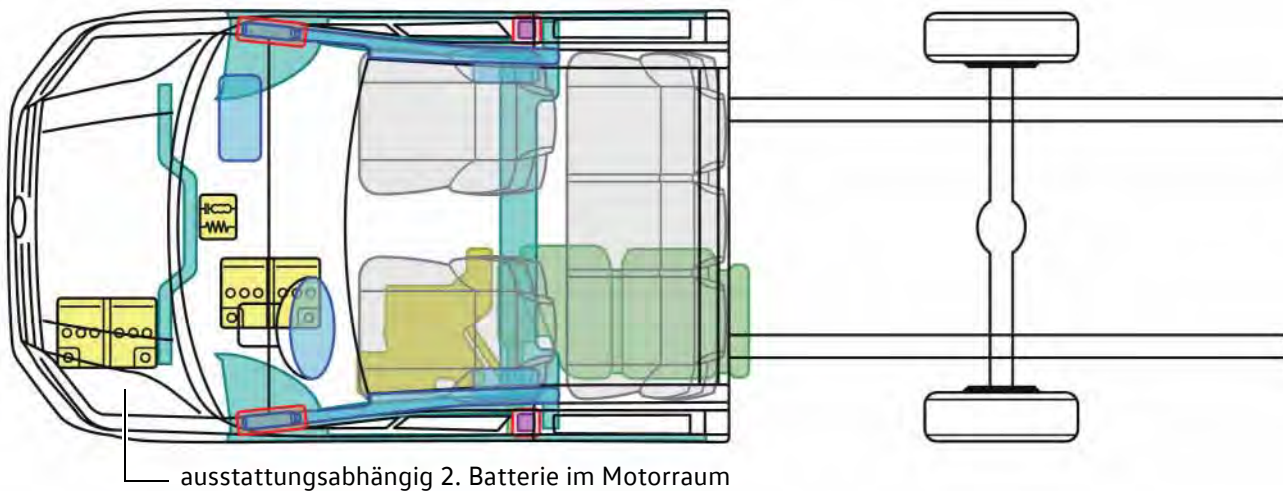



Crafter Fahrgestell

(4-Türer, ab 2017)



Die Sicherheitsausstattung ist für alle Dachhöhen und Radstände einheitlich ausgeführt.

Legende

	Airbag		Karosserie-Verstärkung		Steuergerät		
	Gas-generator				12V-Batterie		
	Gurtstraffer				Kraftstoff-tank		SCR-Tank



Crafter Fahrgestell

(4-Türer, ab 2017)



Fahrzeug deaktivieren

Batterie abklemmen

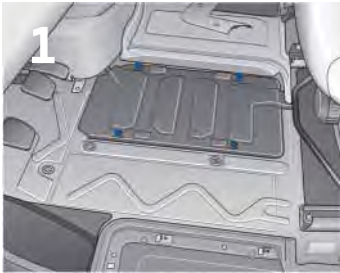

1. Batterieabdeckung im Fußraum vor dem Fahrersitz lokalisieren

- Bodenbelag entfernen
- 4 Verschraubungen lösen und Abdeckung abnehmen



2. Masseanschluss (-) an der Batterie abklemmen



e-Crafter

(ab 2018)

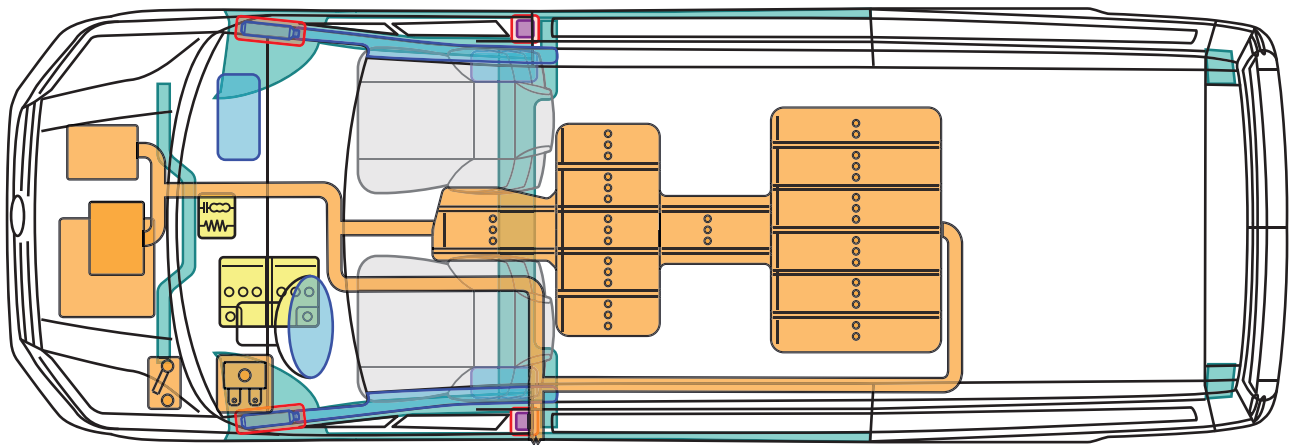





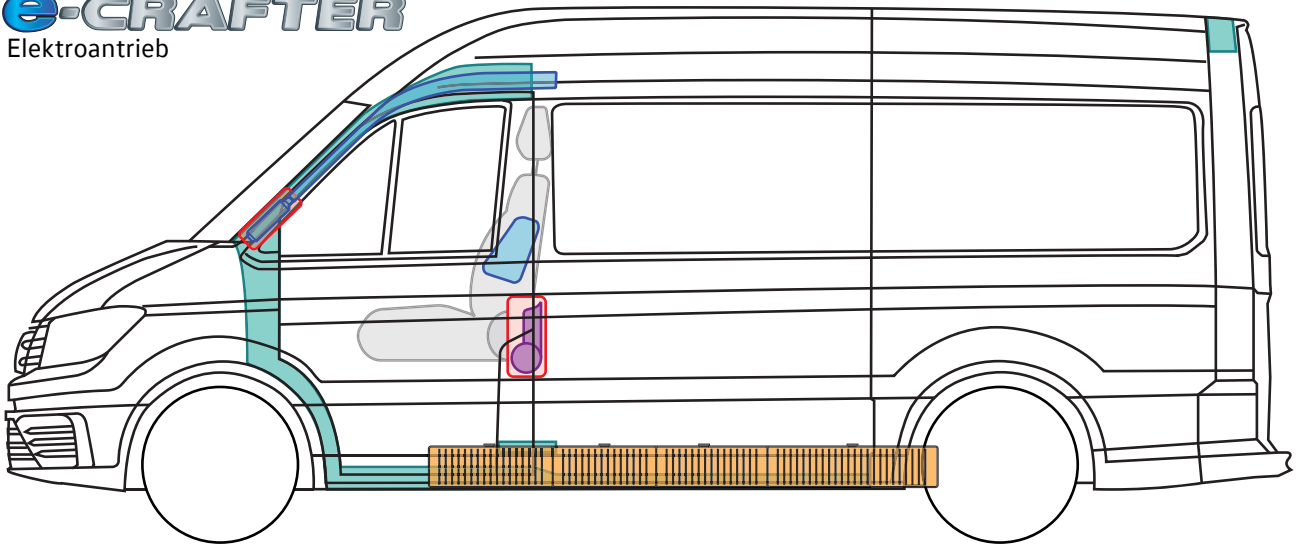





e-CRAFTER

Elektroantrieb



Legende

	Airbag		Karosserie- verstärkung		Steuergerät		Hochvolt- batterie
	Gas- generator		Sicherungs- träger		12V-Batterie		Hochvolt- komponente/ -leitung
	Gurtstraffer		Gasdruck- dämpfer				Trennstelle für Hochvolt



Fahrzeugidentifizierung

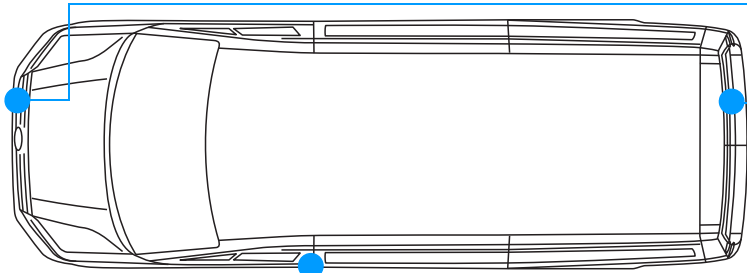
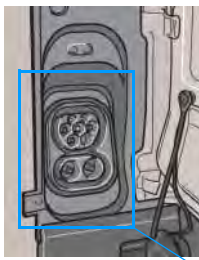

e-CRAFTER

Schriftzug im Kühlergrill
und auf den Hecktüren

Ladesteckdose in der B-Säule

Fahrzeug gegen Wegrollen sichern

1. Gangwahlhebel in Stellung „P“ bringen.
2. Feststellbremse betätigen.

Antrieb und Hochvoltsystem deaktivieren

Antrieb und Hochvoltsystem deaktivieren

(Zündung und Sicherungsträger im Innenraum zugänglich)

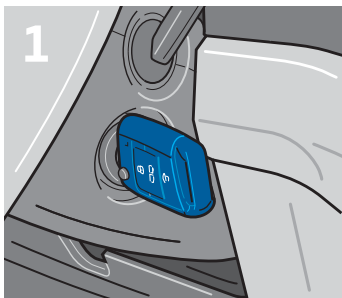

1. Zündschlüssel in „AUS-Stellung“ drehen und abziehen.



Die passiven Sicherheitssysteme wie Airbags und Gurtstraffer sind nach Ablauf der Entladungszeit des Airbagsteuergerätes von ca. 4 Sekunden durch das Drehen des Zündschlüssels in die Stellung „AUS“ deaktiviert.

Vor Ablauf der Entladungszeit besteht eine Gefahr der Airbagauslösung aufgrund der Beschädigung des Airbagsystems.

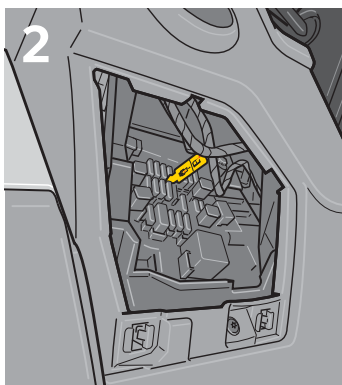

2. Ablagefach über dem Sicherungsträger der Schalttafel links entfernen. Gekennzeichnete Sicherung herausziehen. (gelbe Fahne)



Das Hochvoltsystem ist nach dem Deaktivieren innerhalb von ca. 20 Sekunden spannungsfrei. Die passiven Sicherheitssysteme wie Airbags und Gurtstraffer sind dann deaktiviert.





Antrieb und Hochvoltsystem deaktivieren

Antrieb und Hochvoltsystem deaktivieren (Motorraum zugänglich)

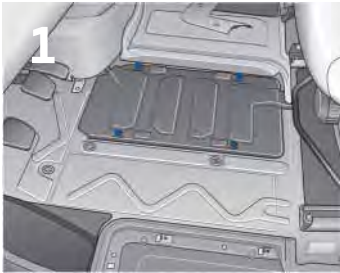

1. Batterieabdeckung im Fußraum vor dem Fahrersitz lokalisieren

- Bodenbelag entfernen
- 4 Verschraubungen lösen und Abdeckung abnehmen



2. Masseanschluss (-) an der Batterie abklemmen

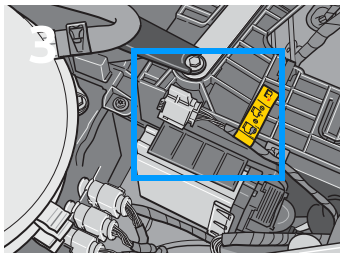

3. Rettungstrennstelle lokalisieren

4. Rettungstrennstelle öffnen

Vorgehensweise ist auf dem Label beschrieben!



Das Hochvoltsystem ist nach dem Deaktivieren innerhalb von ca. 20 Sekunden spannungsfrei. Die passiven Sicherheitssysteme wie Airbags und Gurtstraffer sind dann deaktiviert.

An der Ladesäule angeschlossenes Fahrzeug

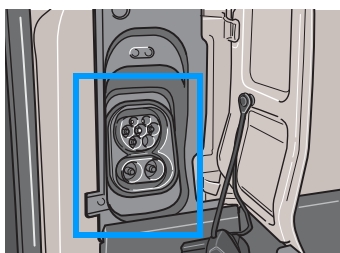

Ladesteckdose B-Säule

Fahrzeug entriegeln.
Das Ladekabel vom Fahrzeug trennen und ggf. bei schweren Unfällen das Hochvoltsystem des Fahrzeugs deaktivieren (siehe unter „Fahrzeug deaktivieren“)!



Eos



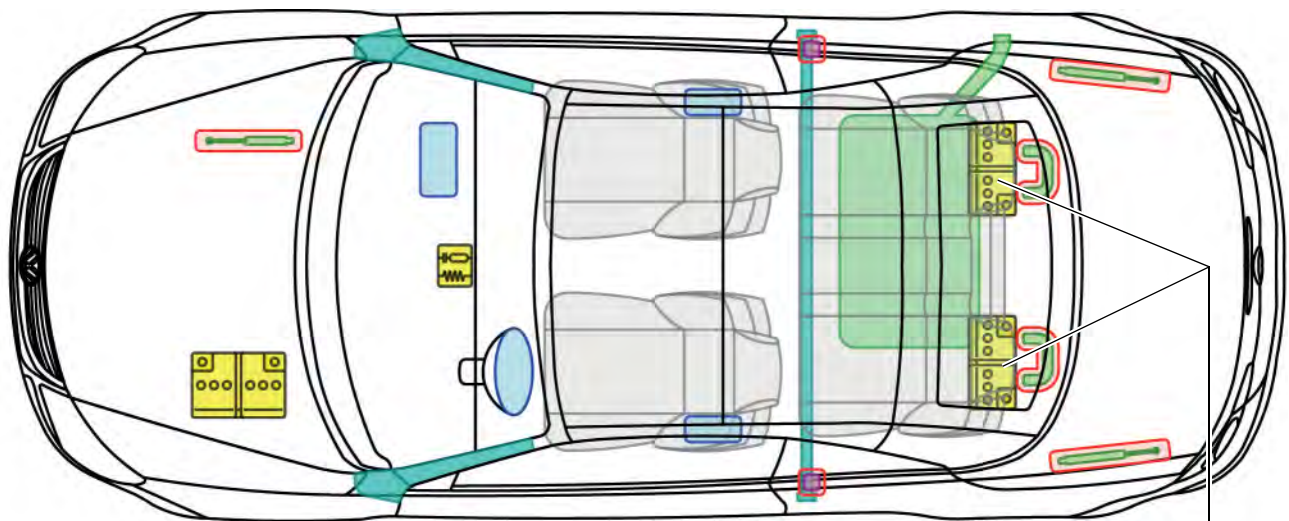



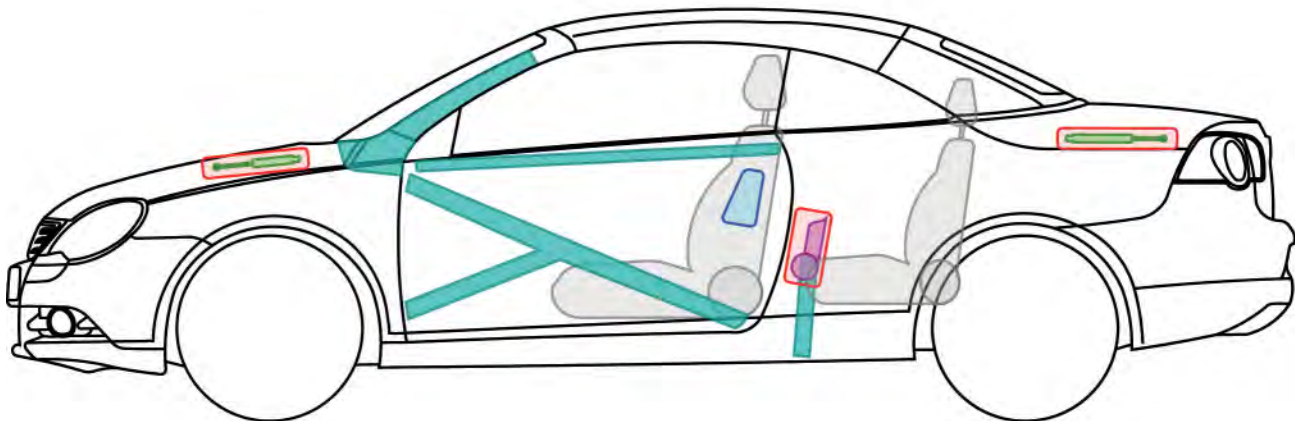

(ab 2006)



2 Batterien hinten nur bei VR6-Motor



Legende

	Airbag		Karosserie-Verstärkung		Steuergerät
			Überroll-schutz		12V-Batterie
	Gurtstraffer		Gasdruck-dämpfer		Kraftstoff-tank



Eos
(ab 2006)



Fahrzeug deaktivieren

Batterien abklemmen (nur bei Eos mit VR6-Motor)



1. Kofferraumboden entriegeln und hochklappen

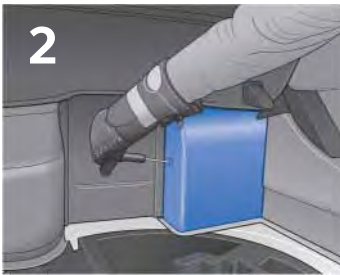

2. Batterieabdeckungen lösen und abnehmen

- Abdeckung rechts hinter der Rücksitzlehne abnehmen
- Abdeckung links hinter der Rücksitzlehne abnehmen

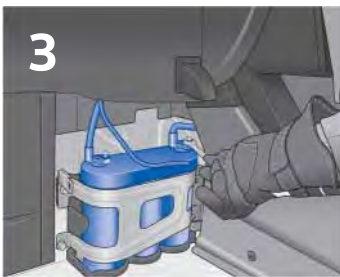

3. Beide Batterien abklemmen

- Masseanschluss an der Batterie auf der rechten Fahrzeugseite lösen und abziehen.
- Masseanschluss an der zweiten Batterie auf der linken Fahrzeugseite lösen und abziehen.

E

Eos (ab 2006)







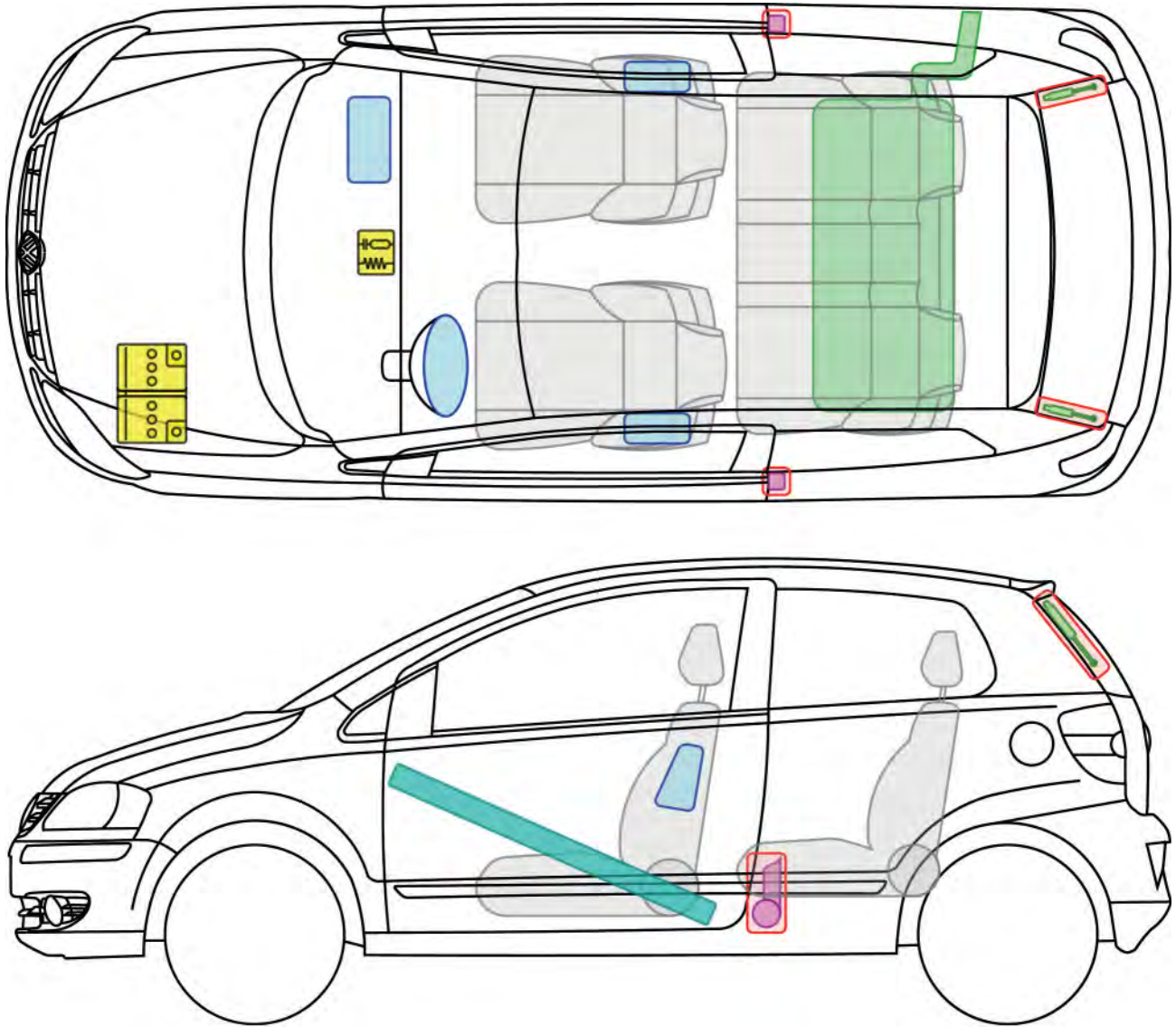

Fox

(ab 2005)



Legende

	Airbag		Karosserie-Verstärkung		Steuergerät	
					12V-Batterie	
	Gurtstraffer		Gasdruck-dämpfer		Kraftstoff-tank	







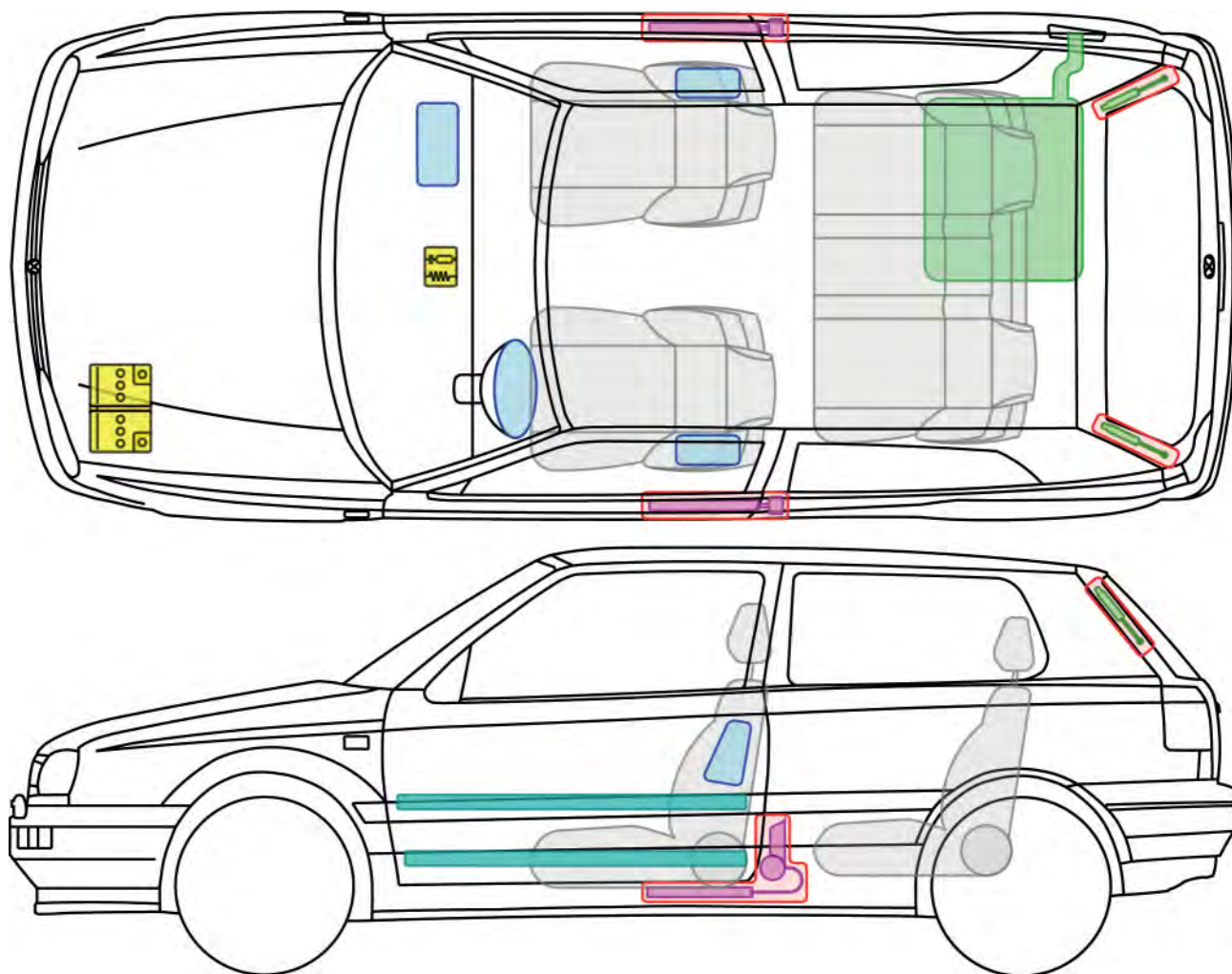

Golf 3

(3-Türer, ab 1991)



Legende

	Airbag		Karosserie-Verstärkung		Steuergerät
					12V-Batterie
	Gurtstraffer		Gasdruck-dämpfer		Kraftstoff-tank







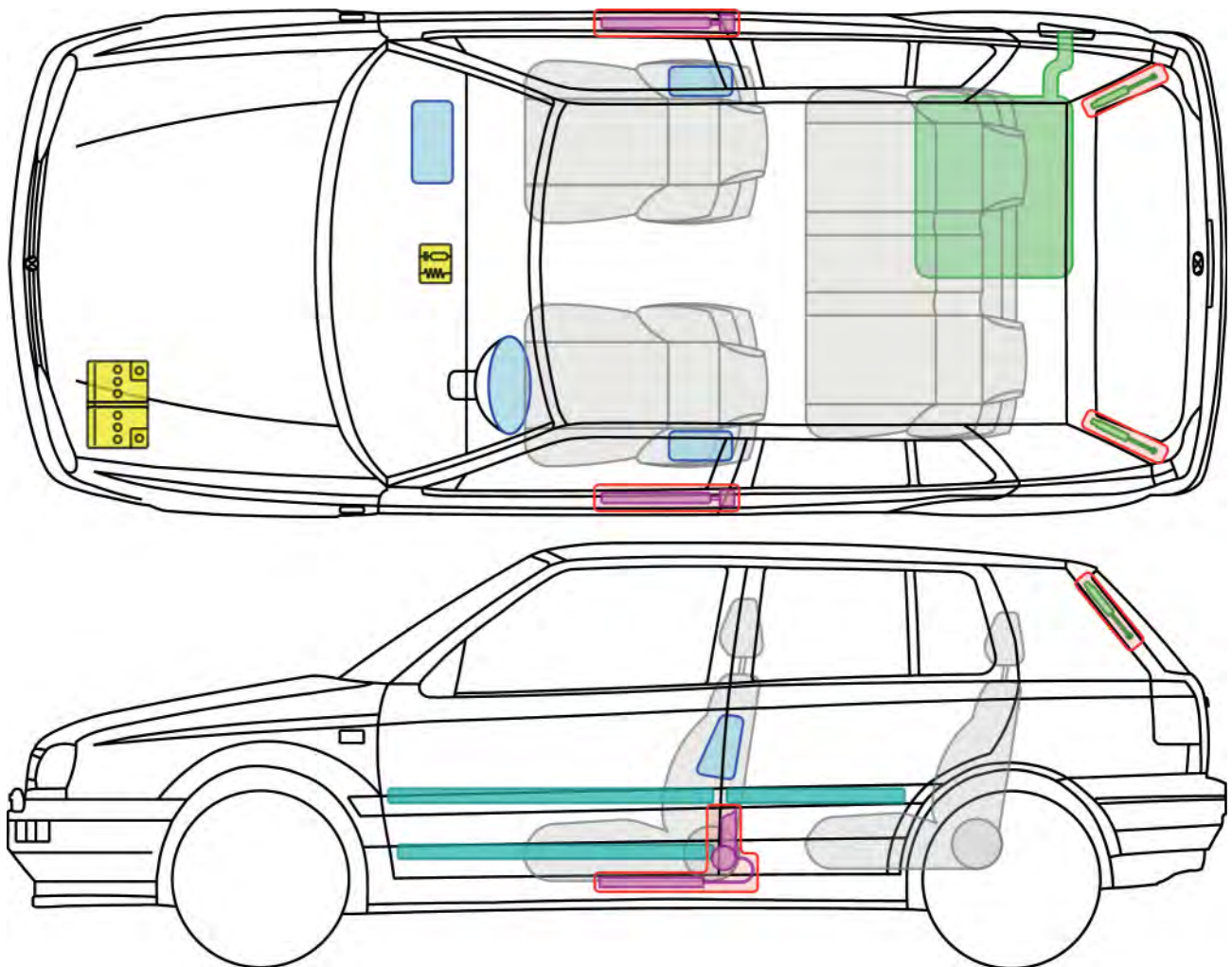

Golf 3

(5-Türer, ab 1991)



Legende

	Airbag		Karosserie-Verstärkung		Steuergerät	
					12V-Batterie	
	Gurtstraffer		Gasdruck-dämpfer		Kraftstoff-tank	







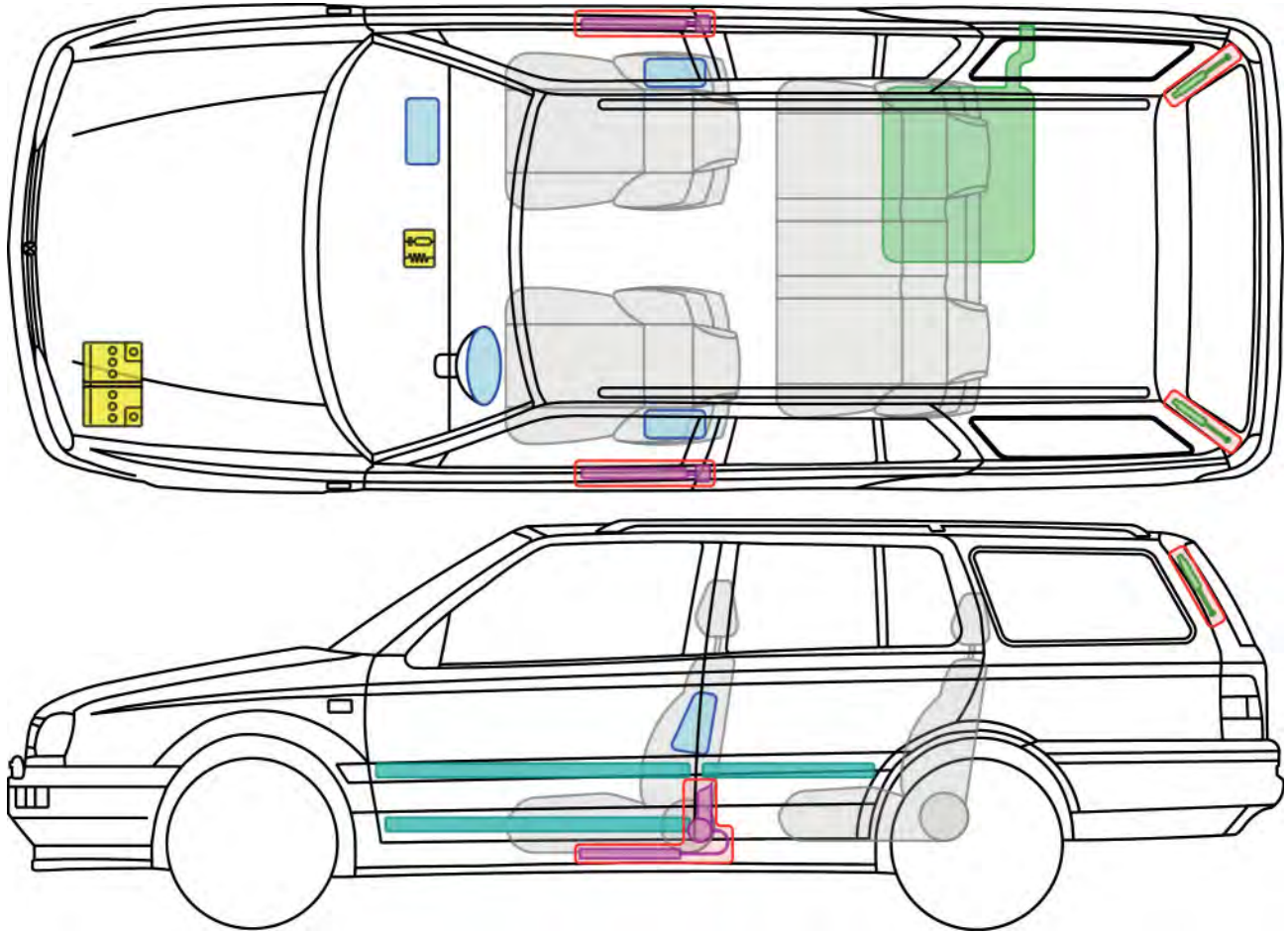

Golf 3

(Variant, ab 1993)



Legende

	Airbag		Karosserie-Verstärkung		Steuergerät	
					12V-Batterie	
	Gurtstraffer		Gasdruck-dämpfer		Kraftstoff-tank	







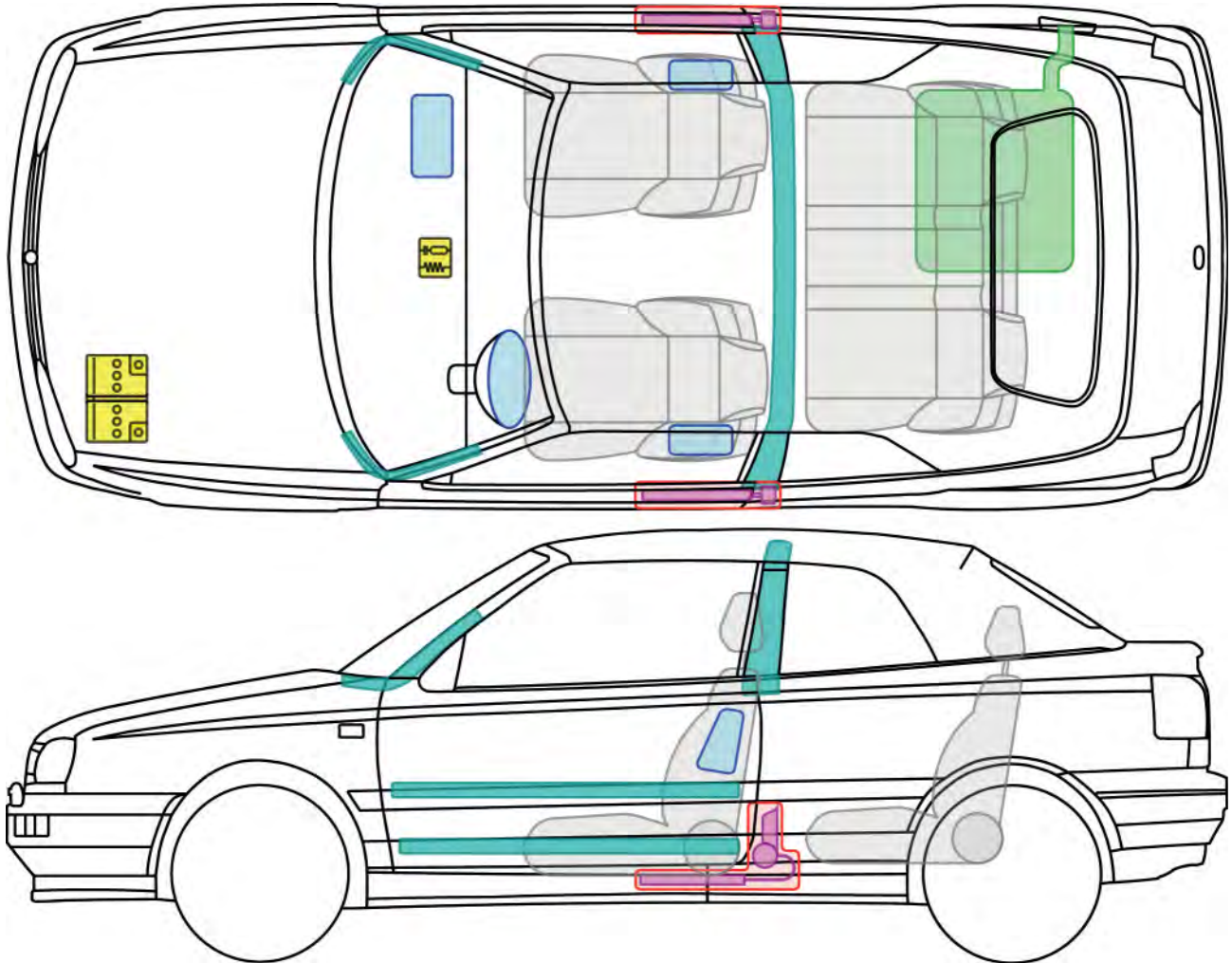

Golf 3

(Cabrio, ab 1993)



Legende

	Airbag		Karosserie-Verstärkung		Steuergerät	
					12V-Batterie	
	Gurtstraffer				Kraftstoff-tank	

G

Golf 3 (Cabrio, ab 1993)







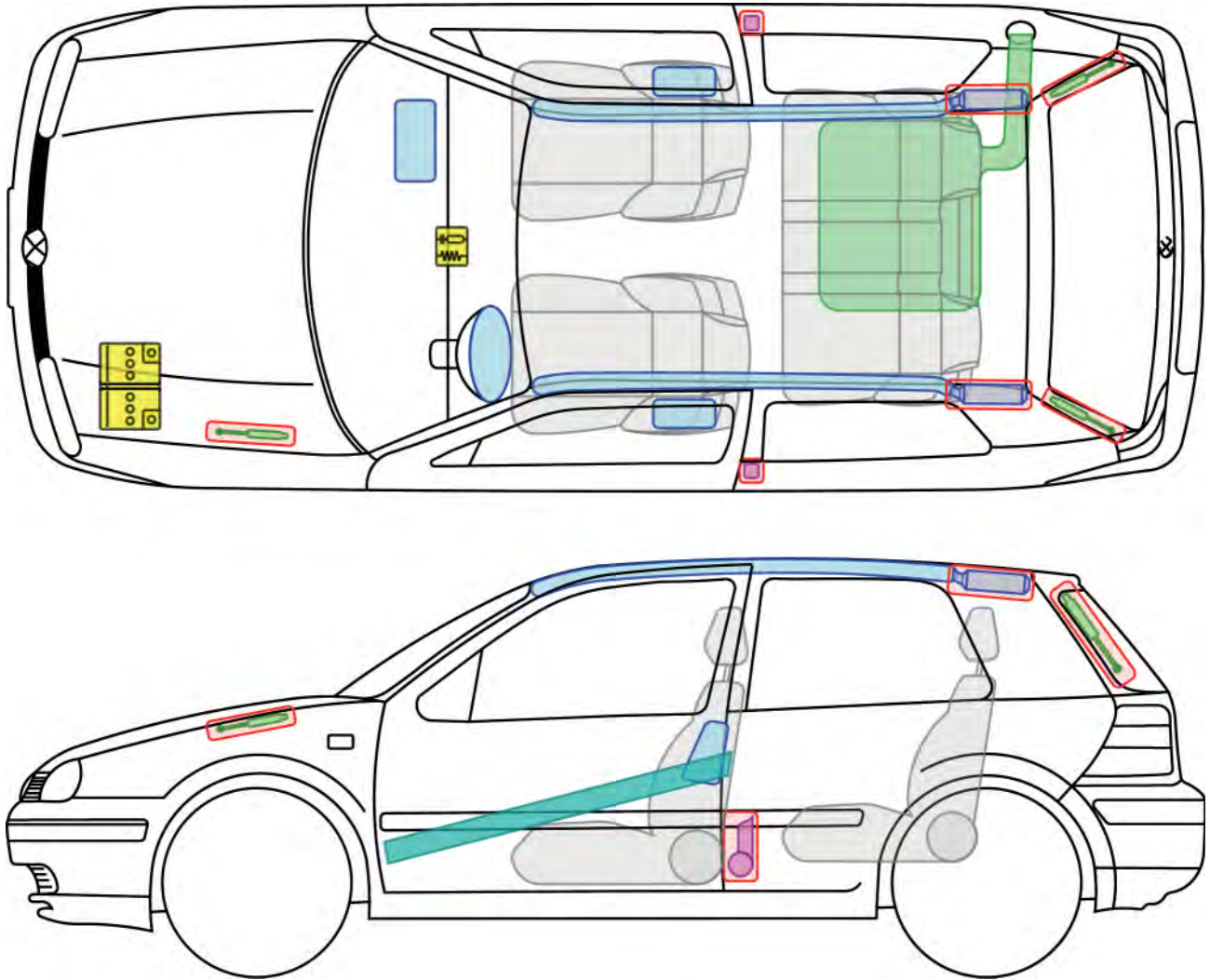



Golf 4

(3-Türer, ab 1997)



Legende

	Airbag		Karosserie-Verstärkung		Steuergerät
	Gas-generator				12V-Batterie
	Gurtstraffer		Gasdruck-dämpfer		Kraftstoff-tank







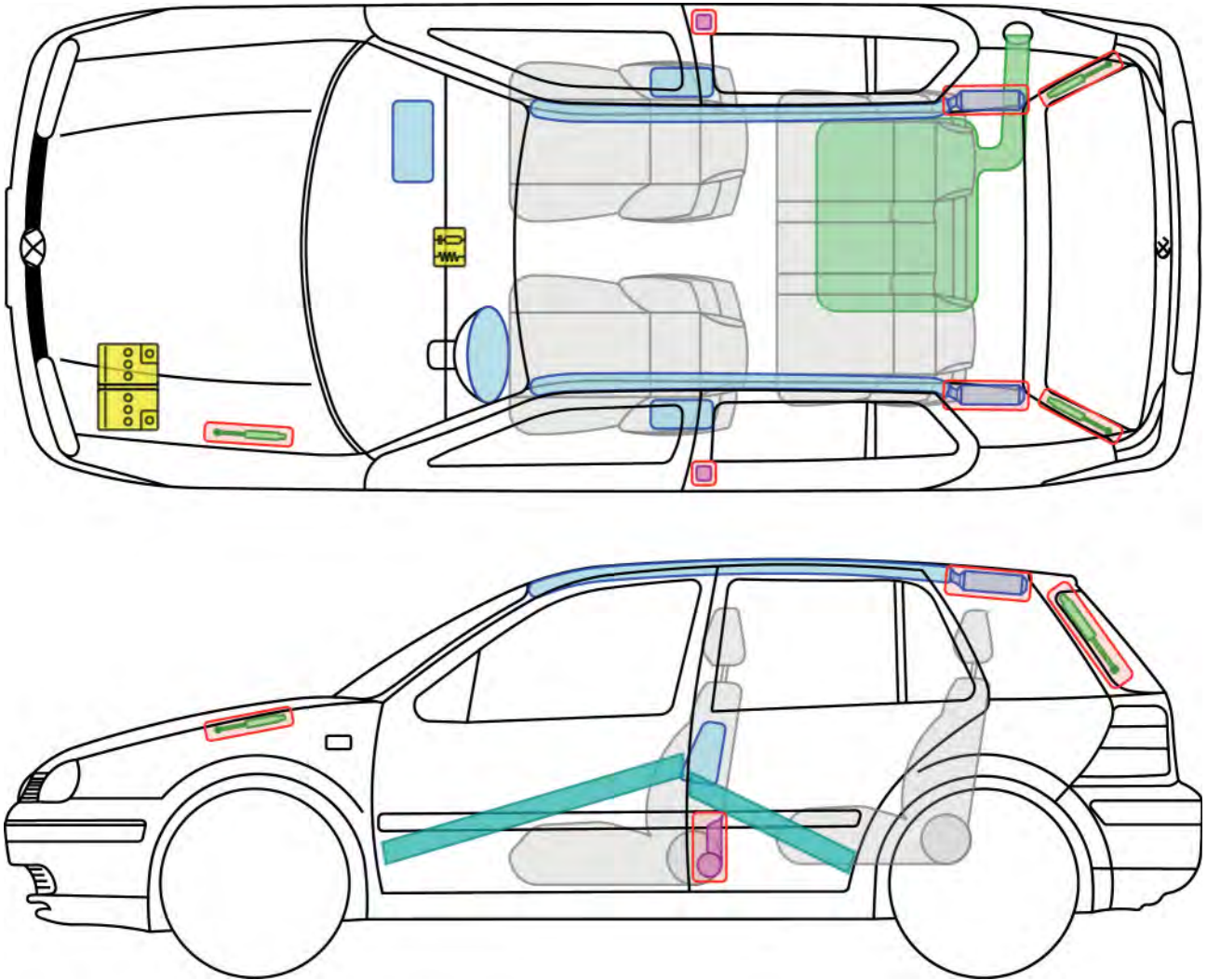



Golf 4

(5-Türer, ab 1997)



Legende

	Airbag		Karosserie-Verstärkung		Steuergerät
	Gas-generator				12V-Batterie
	Gurtstraffer		Gasdruck-dämpfer		Kraftstoff-tank







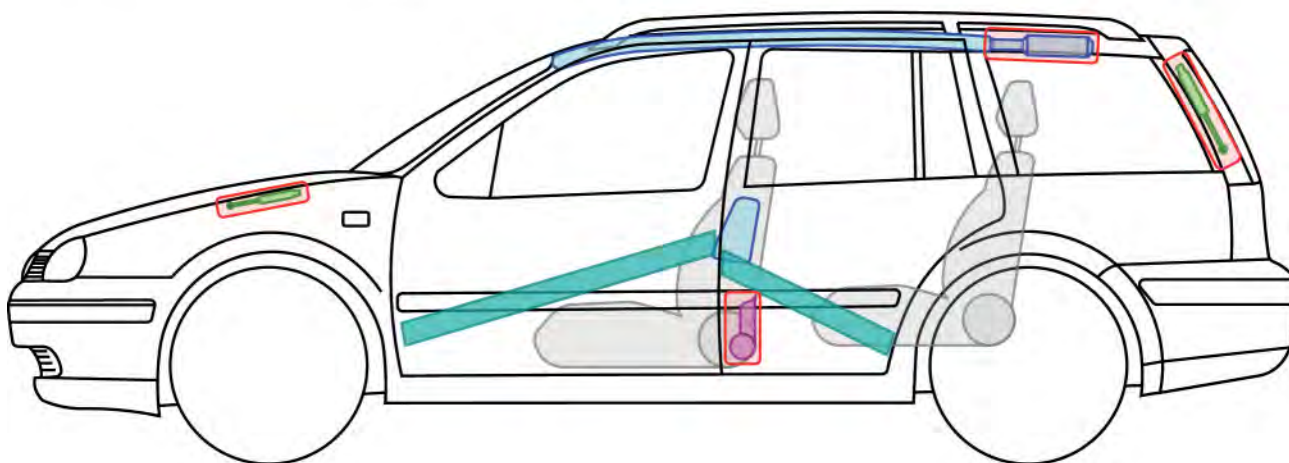
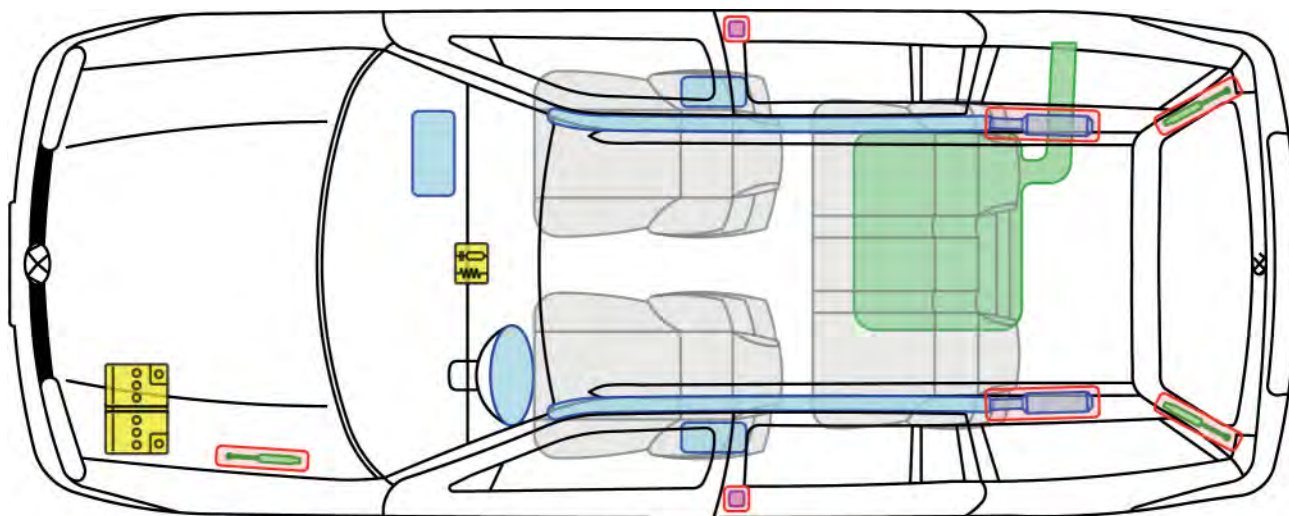



Golf 4

(Variant, ab 1999)



Legende

	Airbag		Karosserie-Verstärkung		Steuergerät
	Gas-generator				12V-Batterie
	Gurtstraffer		Gasdruck-dämpfer		Kraftstoff-tank







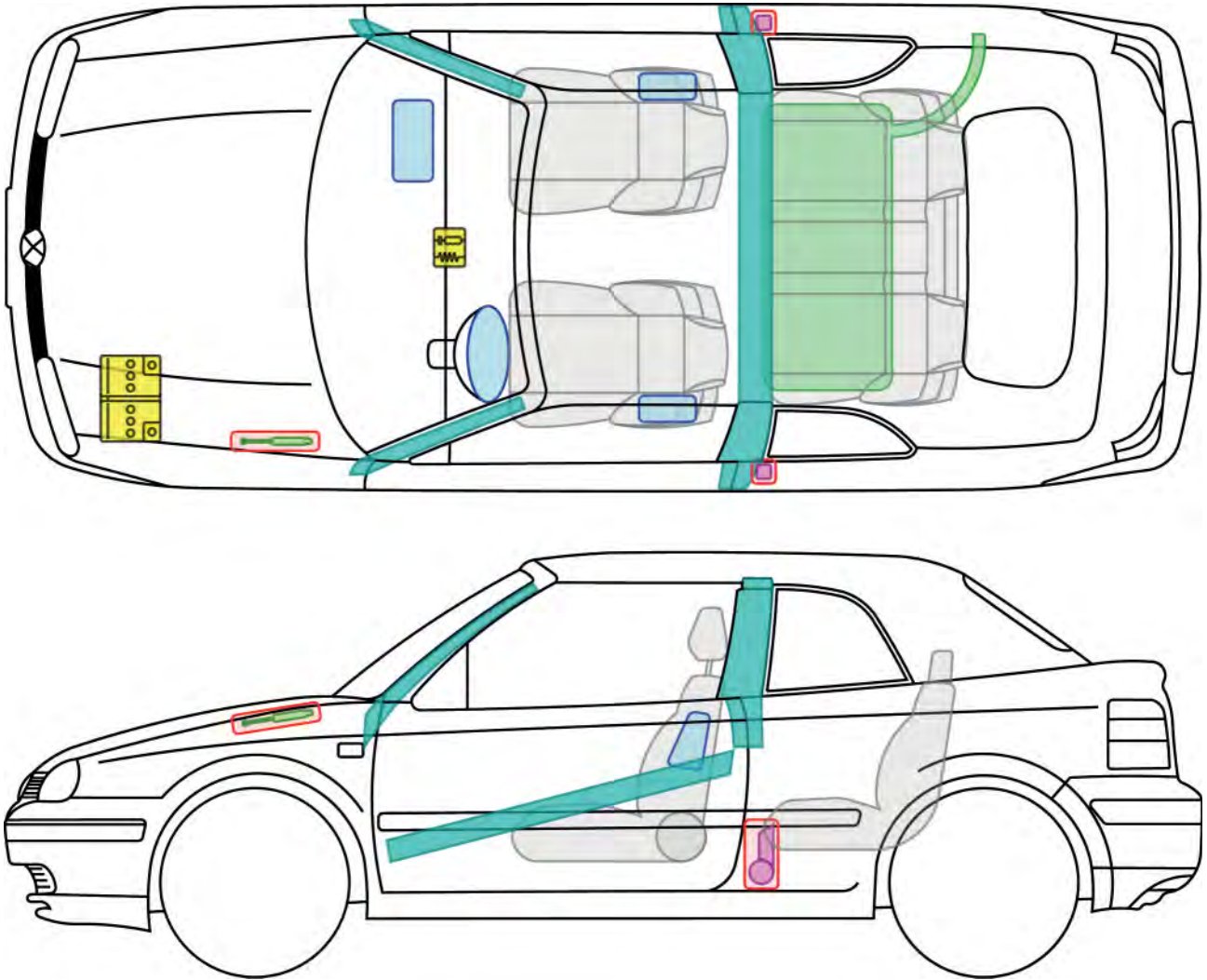

Golf 4

(Cabrio, ab 1998)



Legende

	Airbag		Karosserie-Verstärkung		Steuergerät
					12V-Batterie
	Gurtstraffer		Gasdruck-dämpfer		Kraftstoff-tank



Golf 4

(Variant BiFuel, ab 2003)

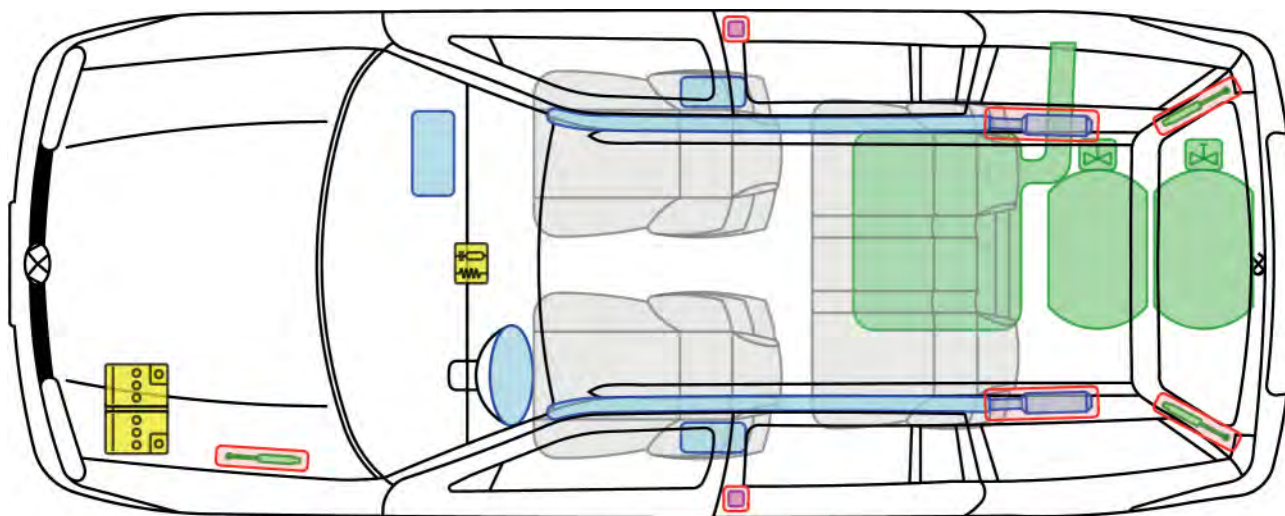





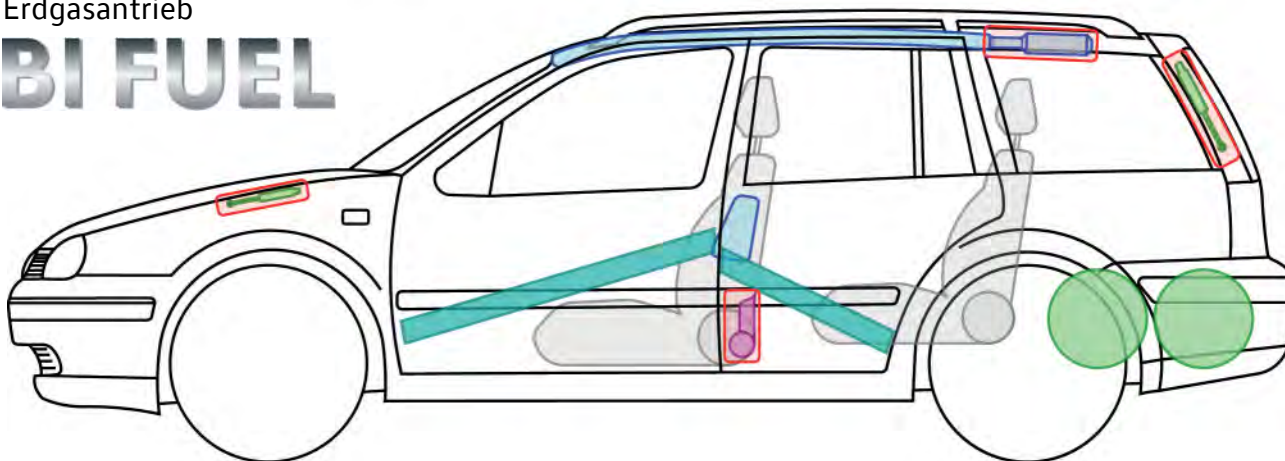





Erdgasantrieb

BI FUEL



Legende

	Airbag		Karosserie-Verstärkung		Steuergerät		Gastank
	Gas-generator				12V-Batterie		Sicherheitsventil
	Gurtstraffer		Gasdruck-dämpfer		Kraftstoff-tank		



Golf 4

(Variant BiFuel, ab 2003)



Hinweise zur Erdgasanlage

Gastanks manuell absperren (bei Gasgeruch bzw. Austritt von Erdgas)

1. Zugang zu den Erdgastanks

- Sie sind unter dem Ladeboden im Kofferraum montiert.
- Zum Hochklappen des Ladebodens die beiden Arretierungsschrauben an der hinteren Kante des Ladebodens gegen den Uhrzeigersinn lösen.



die Gastanks unter dem Ladeboden

2. Absperrhähne lokalisieren

- Jeder Gastank besitzt ein eigenes Flaschenventil mit einem manuellen Absperrhahn.
- Falls einsatzbedingt erforderlich muss jeder Gastank separat abgesperrt werden.

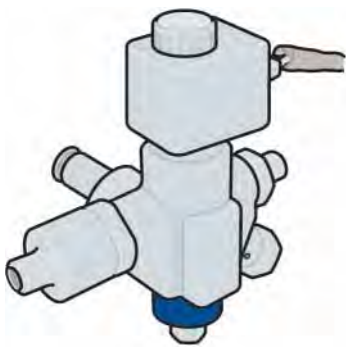

manueller Absperrhahn am Fuß des Flaschenventils.

3. Gastank von Hand schließen

- Falls einsatzbedingt erforderlich muss jeder Gastank separat abgesperrt werden.
- Mit einem 5er-Maul- bzw. Ringschlüssel lässt sich das manuelle Absperrventil am Vierkant durch Drehen im Uhrzeigersinn bis zum Anschlag des Ventils verschließen.



Der Begriff „BiFuel“ wurde bei Einführung von gasbetriebenen Fahrzeugen auch für Erdgasfahrzeuge verwendet. Seit 2009 wird der Begriff „EcoFuel“ für Erdgasfahrzeuge und der Begriff „BiFuel“ für Autogasfahrzeuge (Flüssiggasfahrzeuge) benutzt.



Golf 5







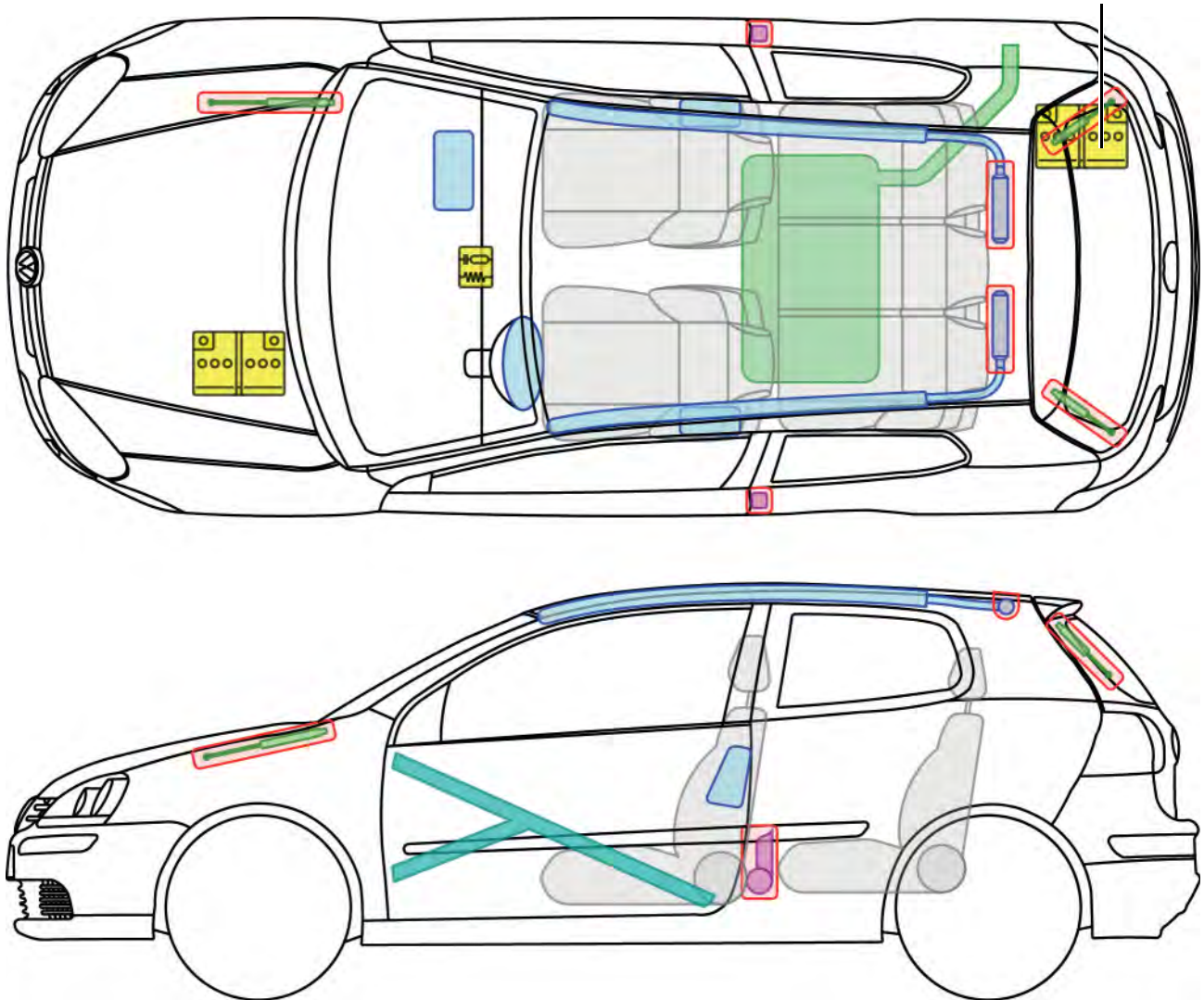

(3-Türer, ab 2003)



nur Golf 5 R32



Legende

	Airbag		Karosserie-Verstärkung		Steuergerät
	Gas-generator				12V-Batterie
	Gurtstraffer		Gasdruck-dämpfer		Kraftstoff-tank



Golf 5

(3-Türer, ab 2003)



Fahrzeug deaktivieren

Batterie abklemmen (gilt nur bei Golf 5 R32)



1. Batterieabdeckung im Kofferraum entfernen

- Batterieabdeckung im Kofferraumboden auf der rechten Fahrzeugseite lokalisieren
- Befestigungsschrauben lösen und Abdeckung abnehmen



2. Masseanschluss (-) an der Batterie abklemmen

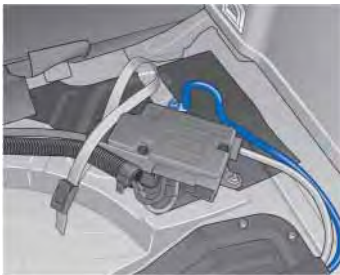

Optionale Methode: Massekontakt an der Karosserie lösen

- Massekontakt auf dem Kofferraumboden unter dem Bordwerkzeug lokalisieren
- Massekontakt mit geeignetem Werkzeug lösen und abziehen



Golf 5







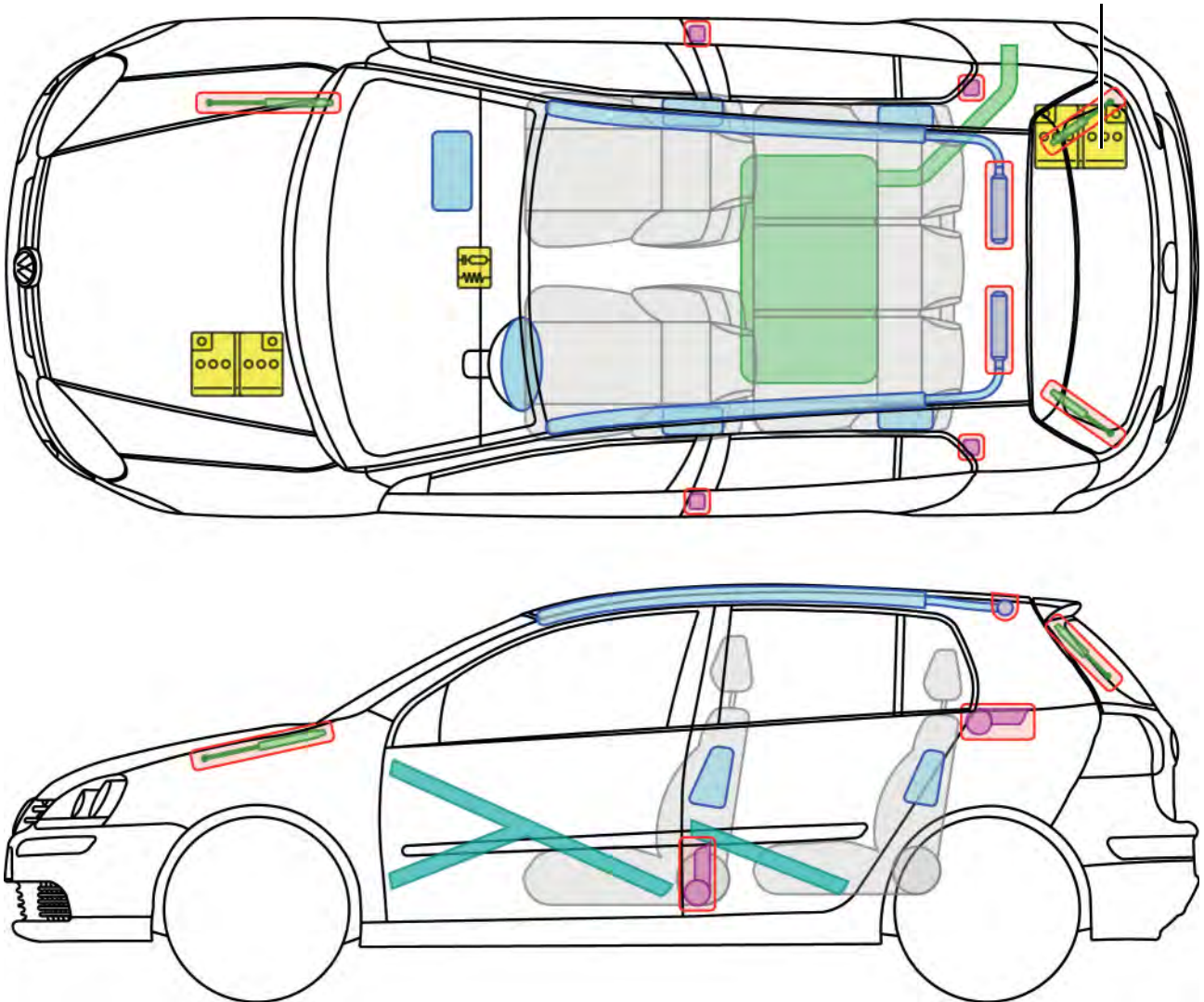

(5-Türer, ab 2003)



nur Golf 5 R32



Legende

	Airbag		Karosserie-Verstärkung		Steuergerät
	Gas-generator				12V-Batterie
	Gurtstraffer		Gasdruck-dämpfer		Kraftstoff-tank



Golf 5

(5-Türer, ab 2003)



Fahrzeug deaktivieren

Batterie abklemmen (nur bei Golf 5 R32)



1. Batterieabdeckung im Kofferraum entfernen

- Batterieabdeckung im Kofferraumboden auf der rechten Fahrzeugseite lokalisieren
- Befestigungsschrauben lösen und Abdeckung abnehmen



2. Masseanschluss (-) an der Batterie abklemmen

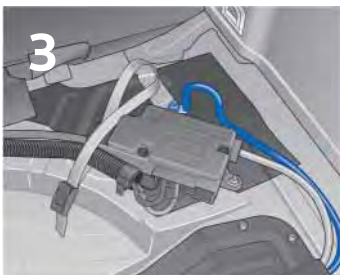

Optionale Methode: Massekontakt an der Karosserie lösen

- Massekontakt auf dem Kofferraumboden unter dem Bordwerkzeug lokalisieren
- Massekontakt mit geeignetem Werkzeug lösen und abziehen







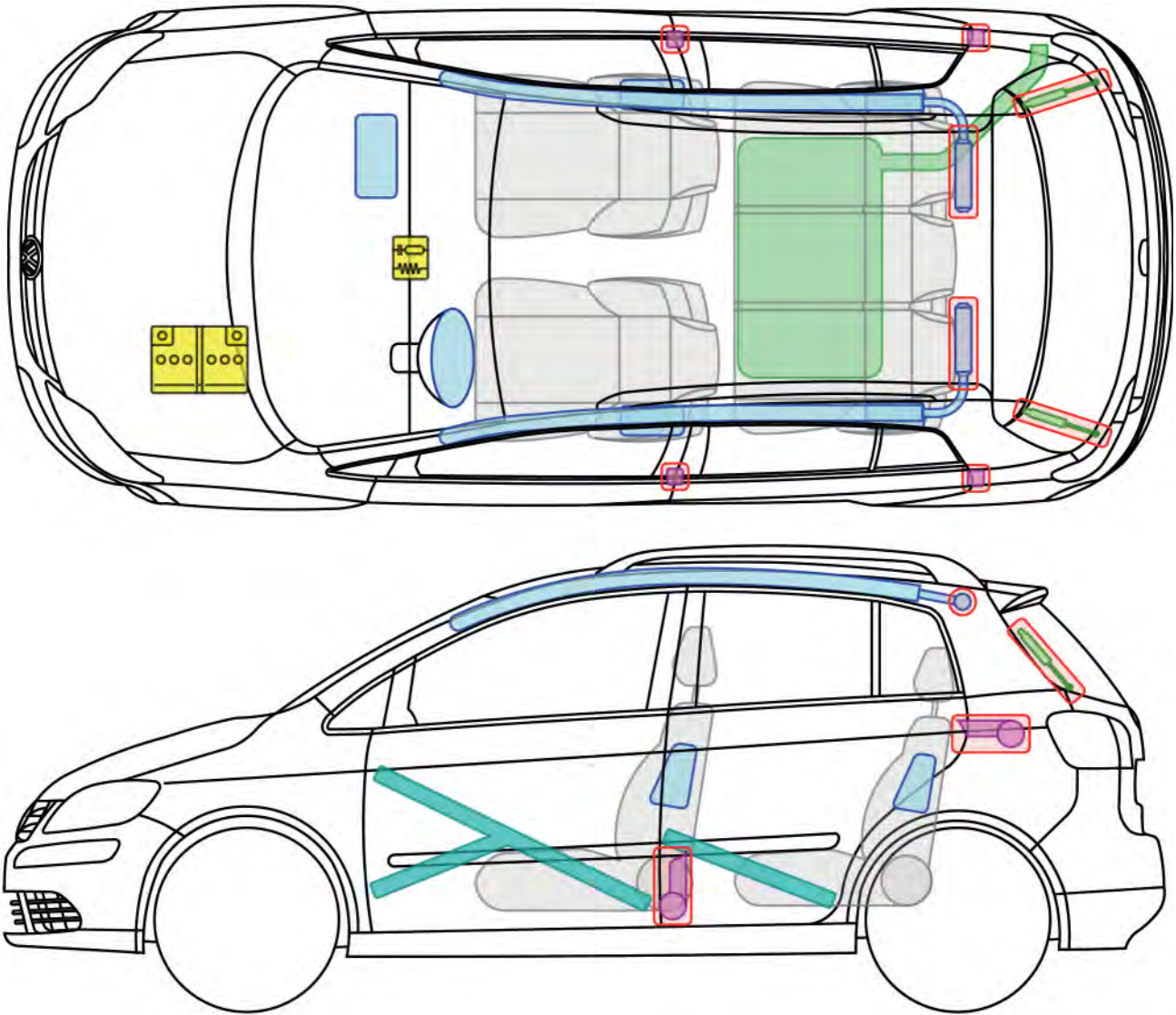



Golf 5 Plus

(ab 2005)



Legende

	Airbag		Karosserie-Verstärkung		Steuergerät
	Gas-generator				12V-Batterie
	Gurtstraffer		Gasdruck-dämpfer		Kraftstoff-tank

G

Golf 5 Plus (ab 2005)







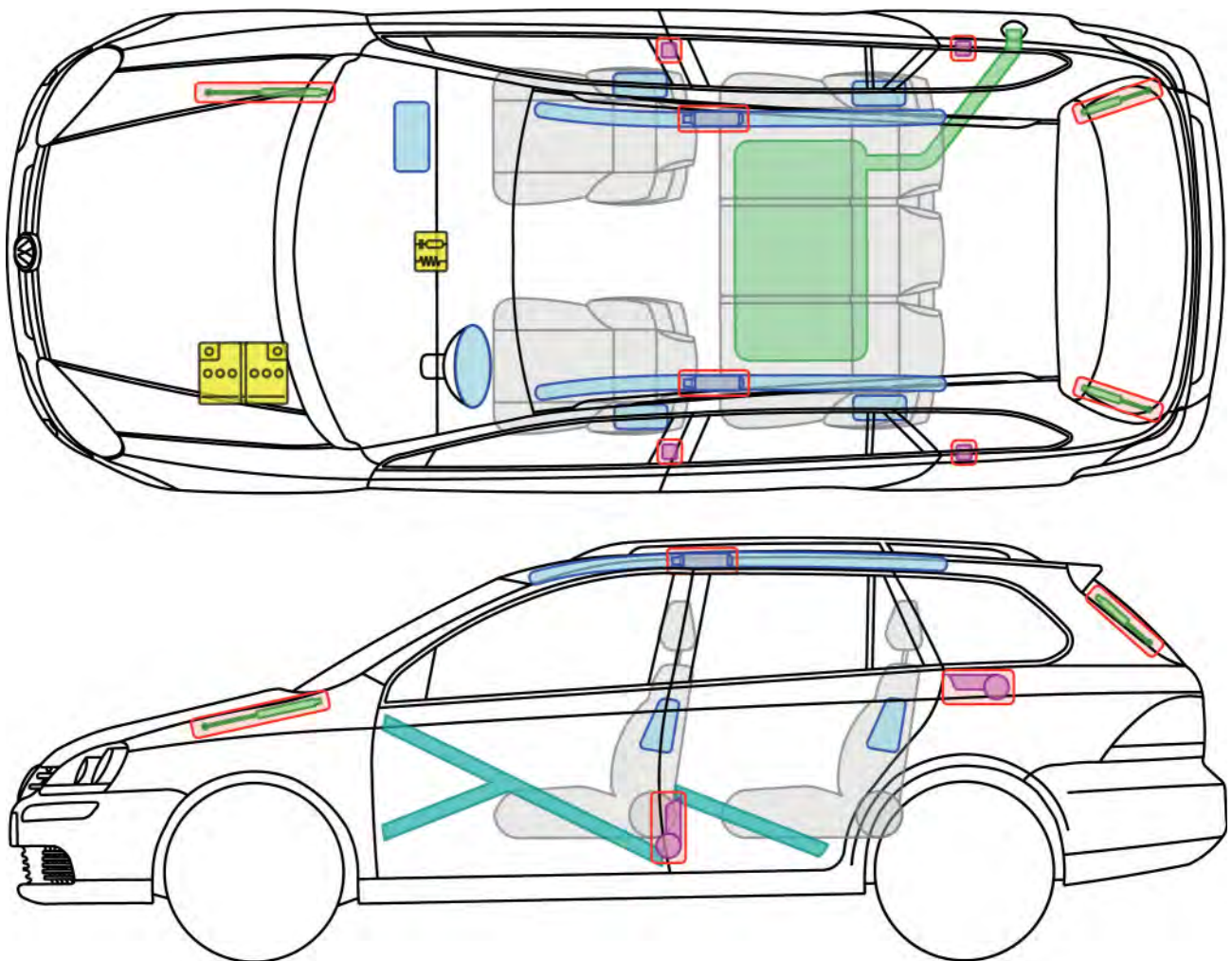



Golf 5

(Variant, ab 2006)



Legende

	Airbag		Karosserie-Verstärkung		Steuergerät
	Gas-generator				12V-Batterie
	Gurtstraffer		Gasdruck-dämpfer		Kraftstoff-tank







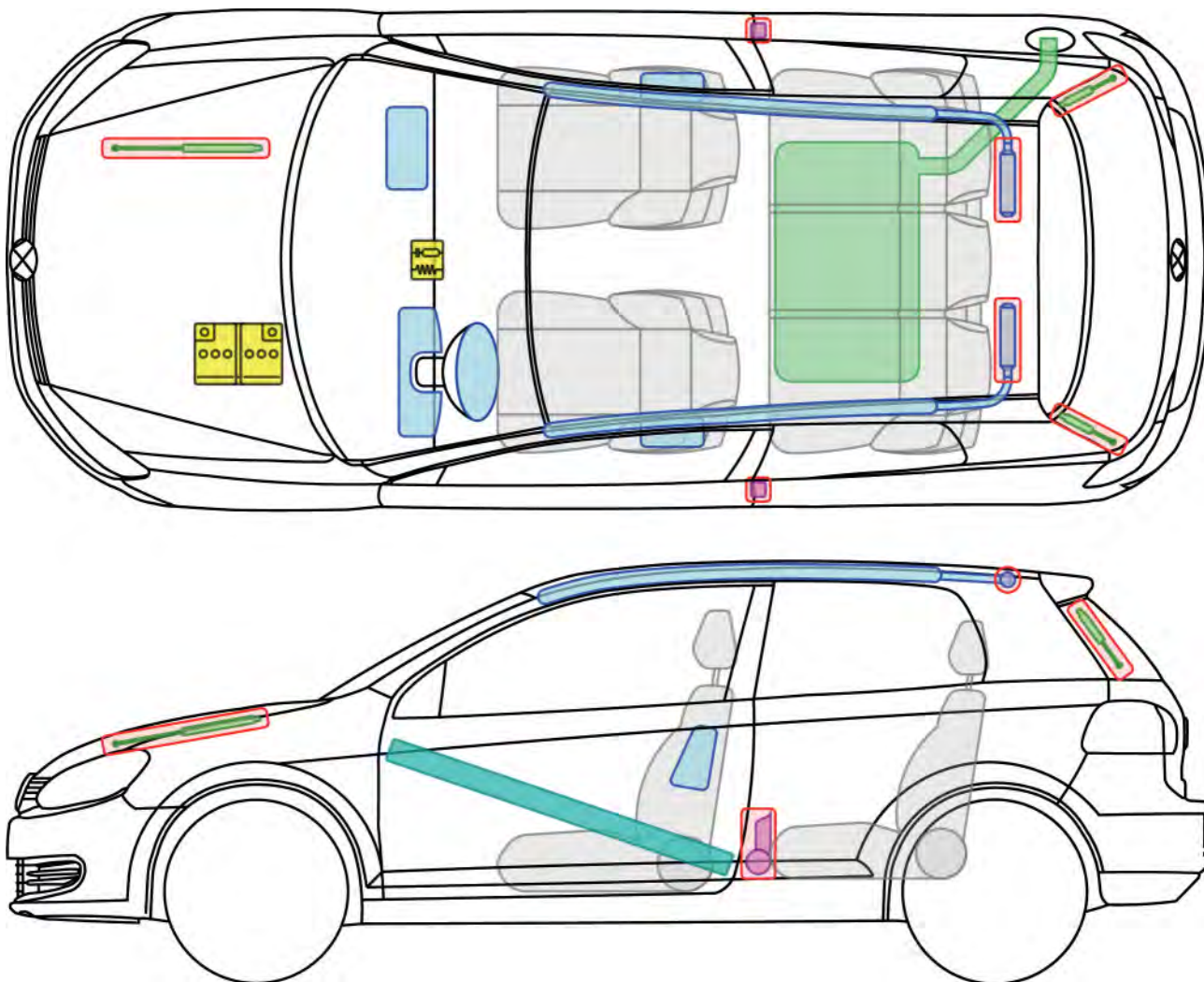



Golf 6

(3-Türer, ab 2008)



Legende

	Airbag		Karosserie-Verstärkung		Steuergerät
	Gas-generator				12V-Batterie
	Gurtstraffer		Gasdruck-dämpfer		Kraftstoff-tank







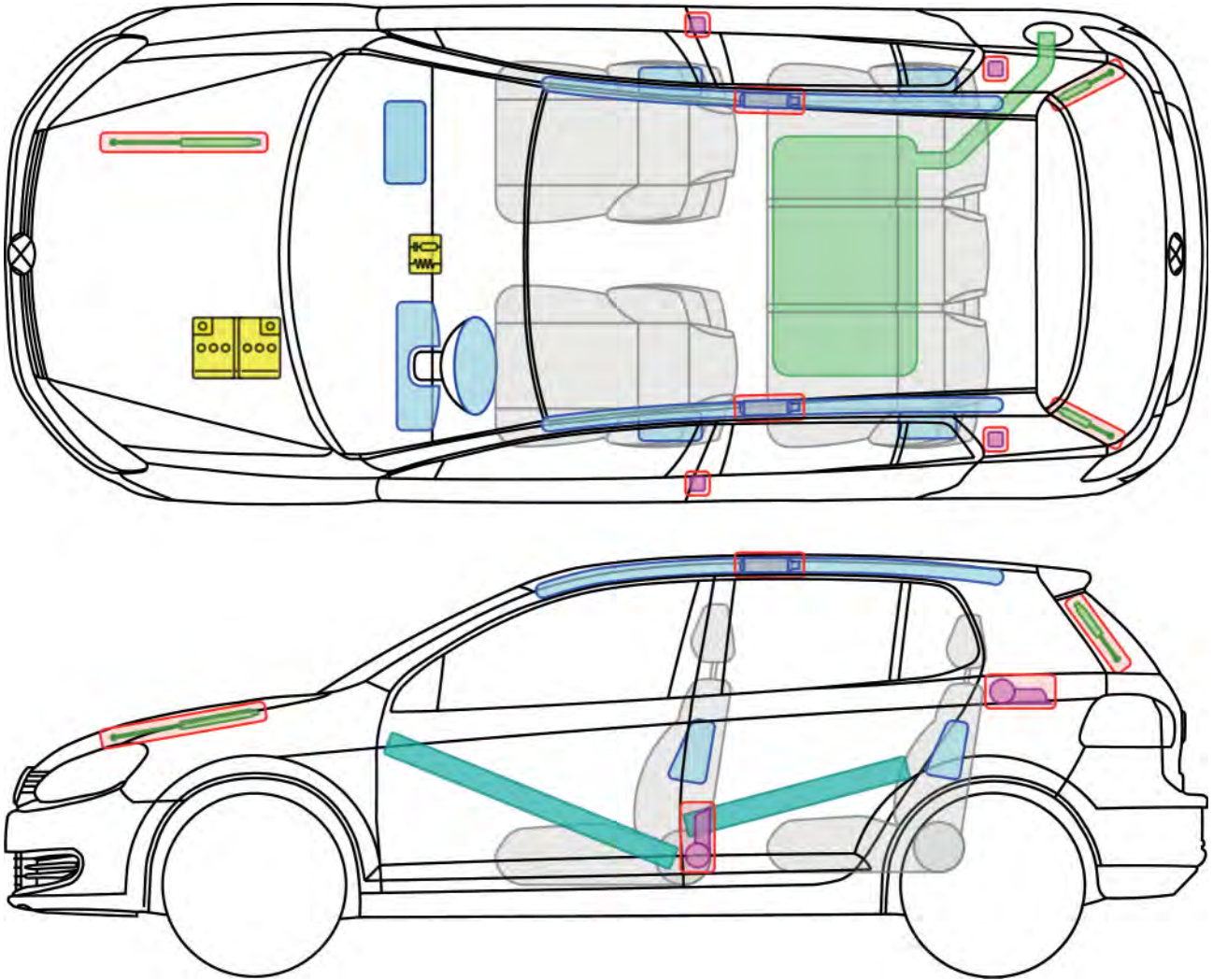



Golf 6

(5-Türer, ab 2008)



Legende

	Airbag		Karosserie-Verstärkung		Steuergerät
	Gas-generator				12V-Batterie
	Gurtstraffer		Gasdruck-dämpfer		Kraftstoff-tank



Golf 6

(3-Türer BiFuel, ab 2009)

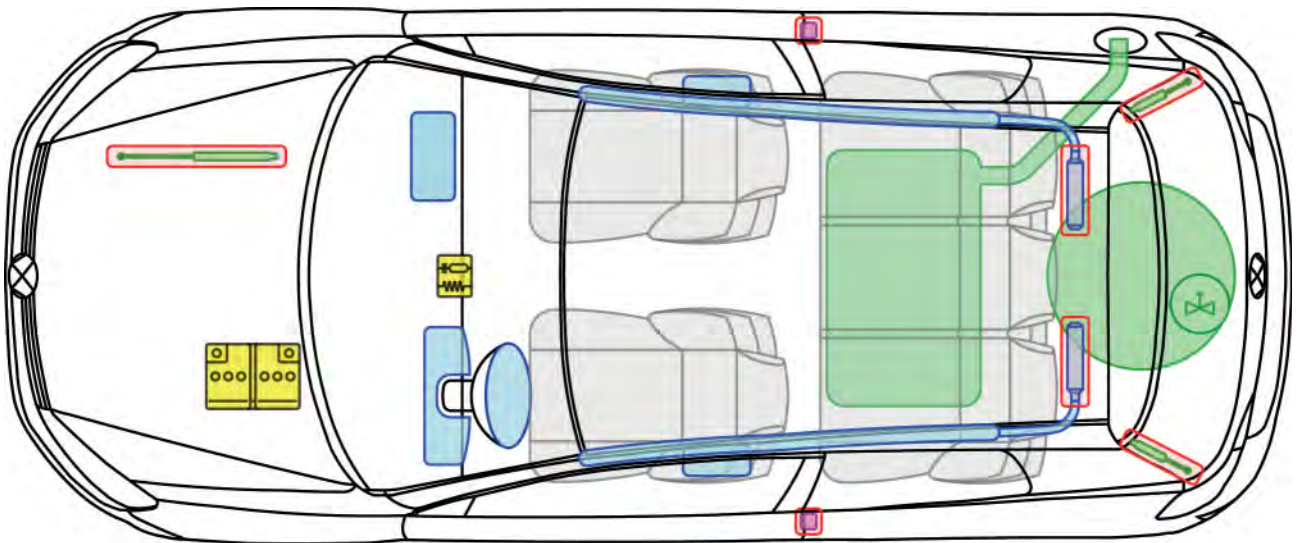





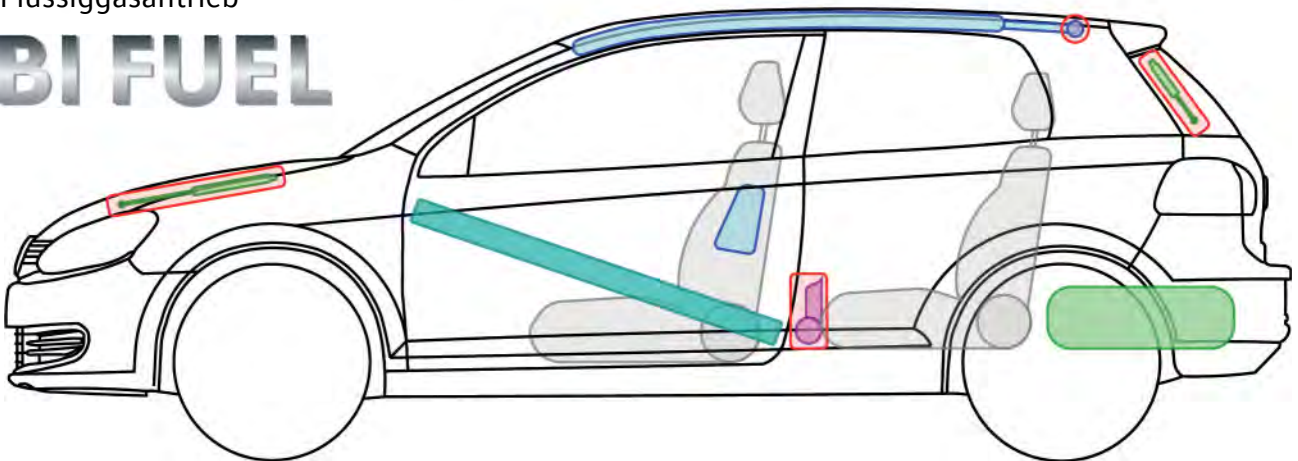





Flüssiggasantrieb

BI FUEL



Legende

	Airbag		Karosserie-Verstärkung		Steuergerät		Gastank
	Gas-generator				12V-Batterie		Sicherheits-ventil
	Gurtstraffer		Gasdruck-dämpfer		Kraftstoff-tank		

G

Golf 6 (3-Türer BiFuel, ab 2009)



Golf 6

(3-Türer BiFuel, ab 2009)



Hinweise zur Flüssiggasanlage

Der Gastank der Flüssiggasanlage des Golf 6 BiFuel hat keine mechanische, manuelle Absperrmöglichkeit!



Der Flüssiggastank in der Reserveradmulde

1. Flüssiggastank lokalisieren

- Er ist unter dem Ladeboden in der Reserveradmulde montiert.
- Der Gastank verfügt nur über ein elektromagnetisches Absperrventil, das stromlos geschlossen ist.



Golf 6

(5-Türer BiFuel, ab 2009)

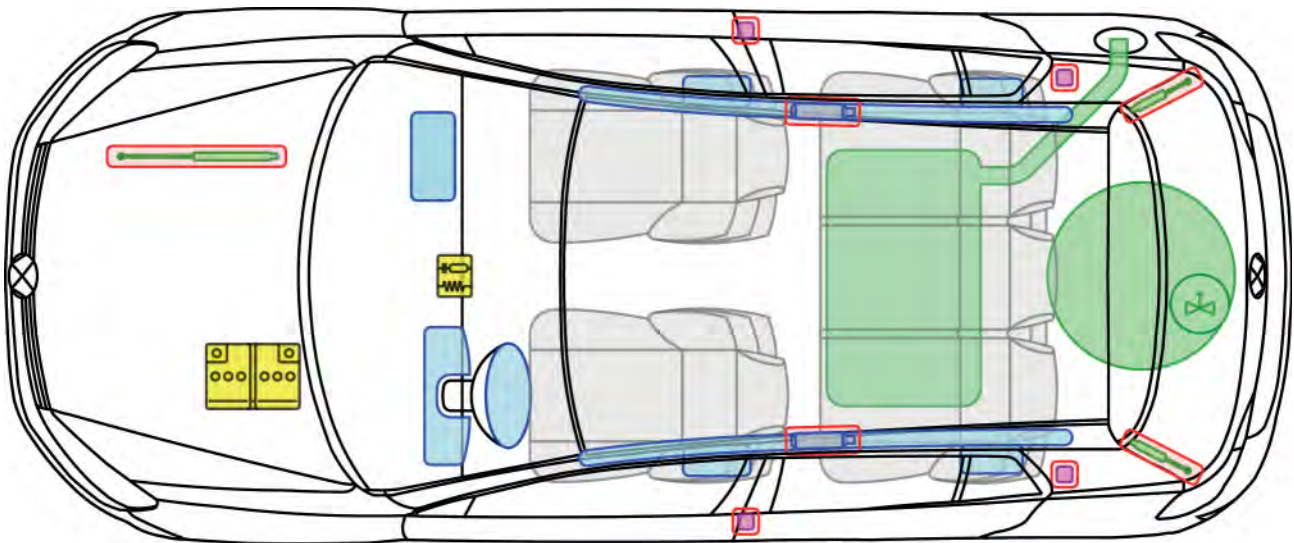





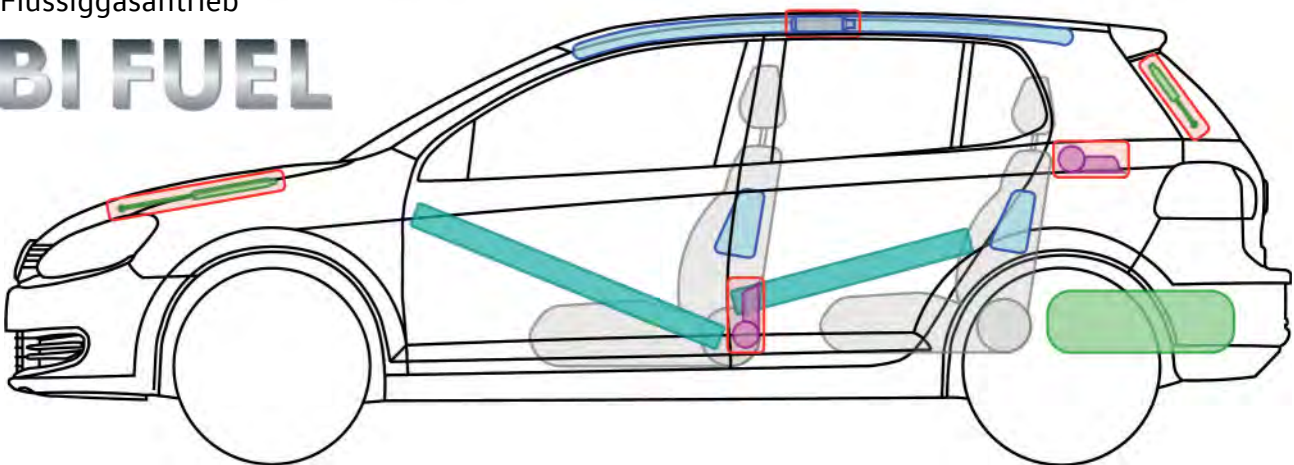





Flüssiggasantrieb

BI FUEL



Legende

	Airbag		Karosserie-Verstärkung		Steuergerät		Gastank
	Gas-generator				12V-Batterie		Sicherheitsventil
	Gurtstraffer		Gasdruck-dämpfer		Kraftstoff-tank		

G

Golf 6 (5-Türer BiFuel, ab 2009)



Golf 6

(5-Türer BiFuel, ab 2009)



Hinweise zur Flüssiggasanlage

Der Gastank der Flüssiggasanlage des Golf 6 BiFuel hat keine mechanische, manuelle Absperrmöglichkeit!



Der Flüssiggastank in der Reserveradmulde

1. Flüssiggastank lokalisieren

- Er ist unter dem Ladeboden in der Reserveradmulde montiert.
- Der Gastank verfügt nur über ein elektromagnetisches Absperrventil, das stromlos geschlossen ist.







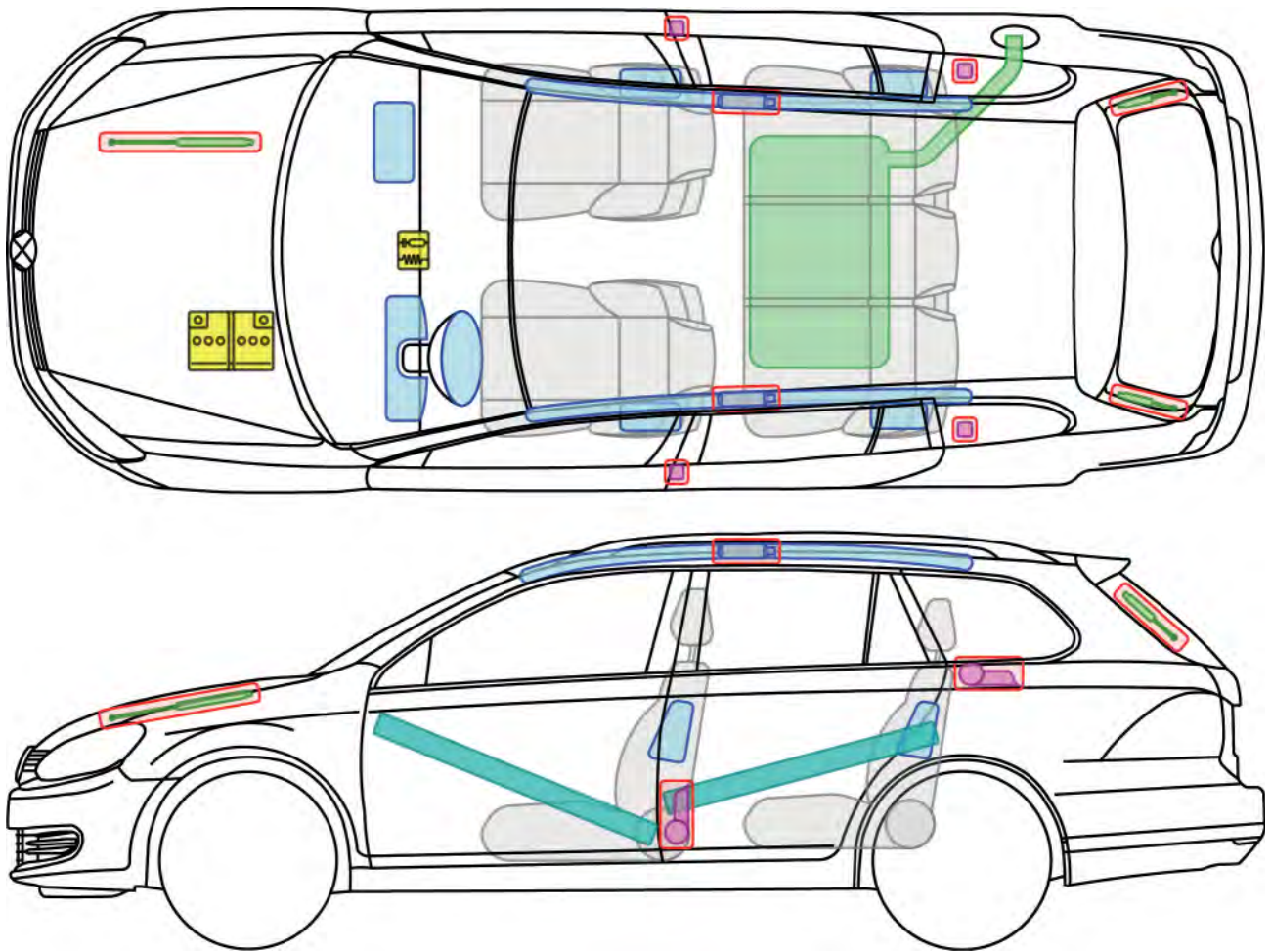



Golf 6

(Variant, ab 2009)



Legende

	Airbag		Karosserie-Verstärkung		Steuergerät
	Gas-generator				12V-Batterie
	Gurtstraffer		Gasdruck-dämpfer		Kraftstoff-tank







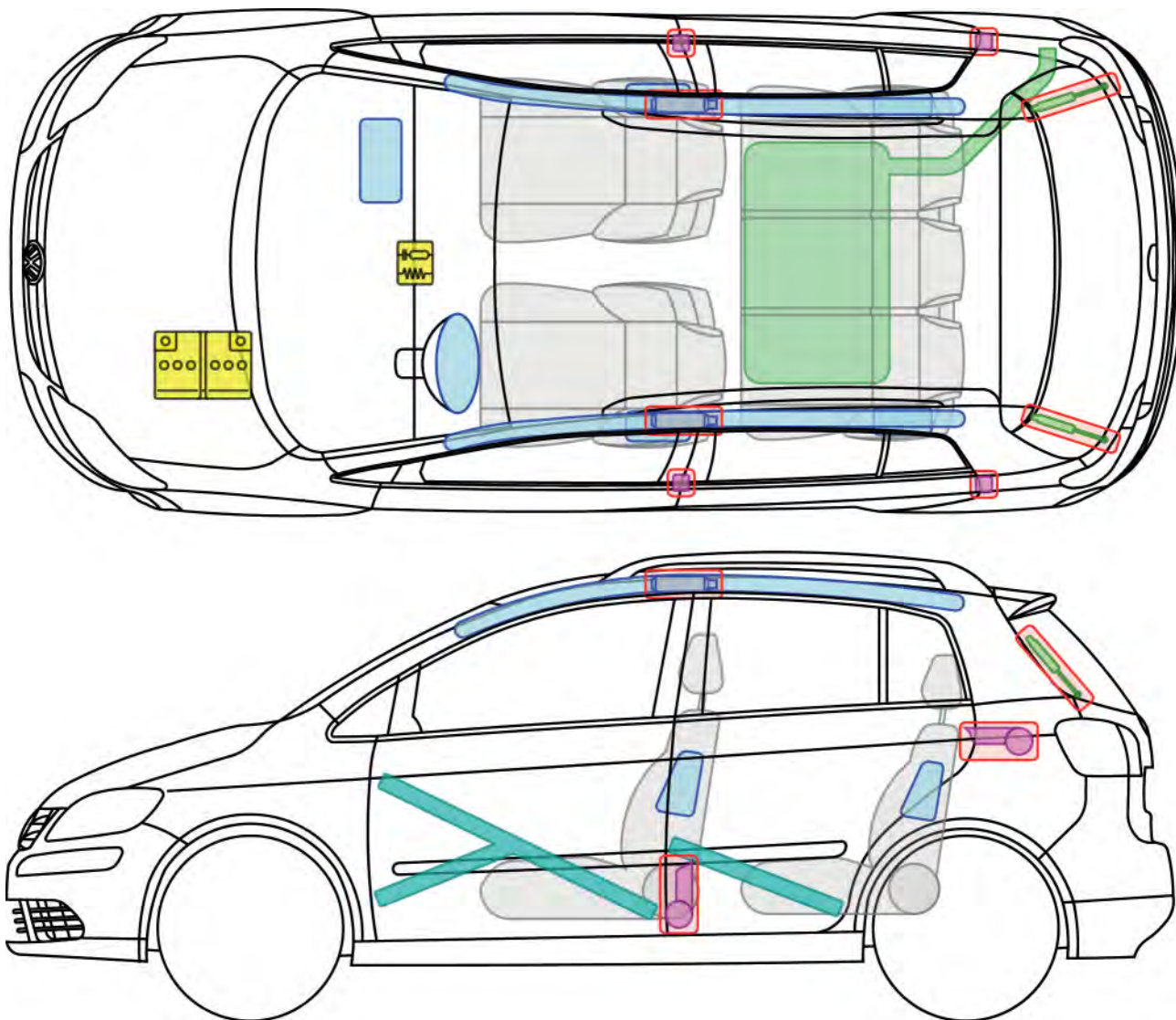



Golf 6 Plus

(ab 2009)



Legende

	Airbag		Karosserie-Verstärkung		Steuergerät
	Gas-generator				12V-Batterie
	Gurtstraffer		Gasdruck-dämpfer		Kraftstoff-tank



Golf 6 Plus

(BiFuel, ab 2009)

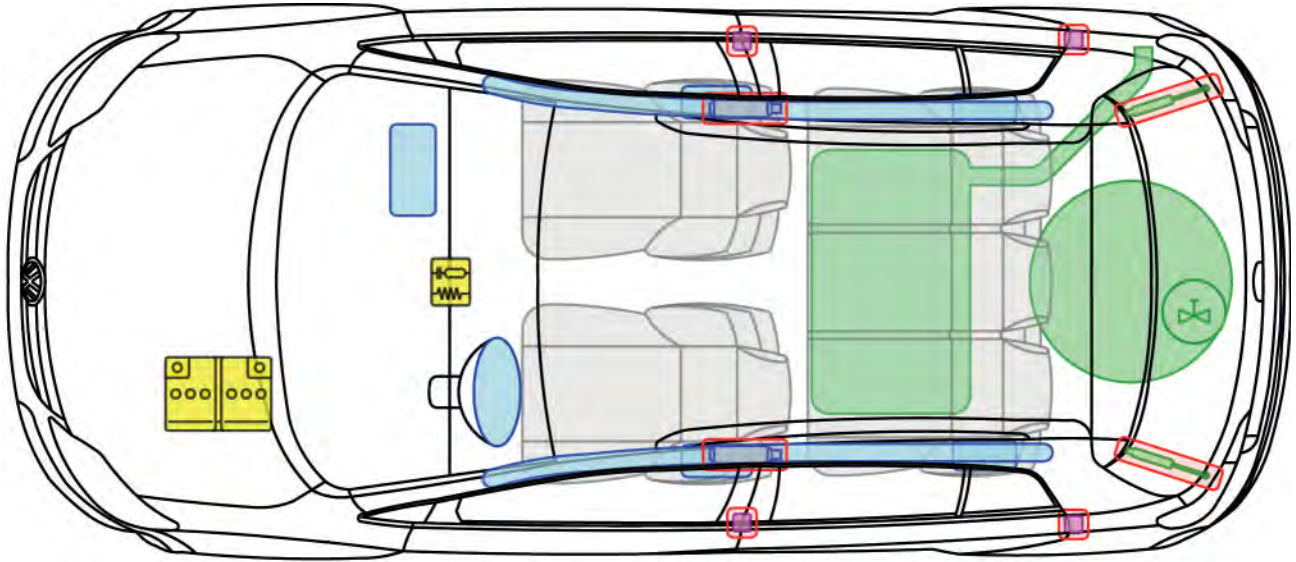





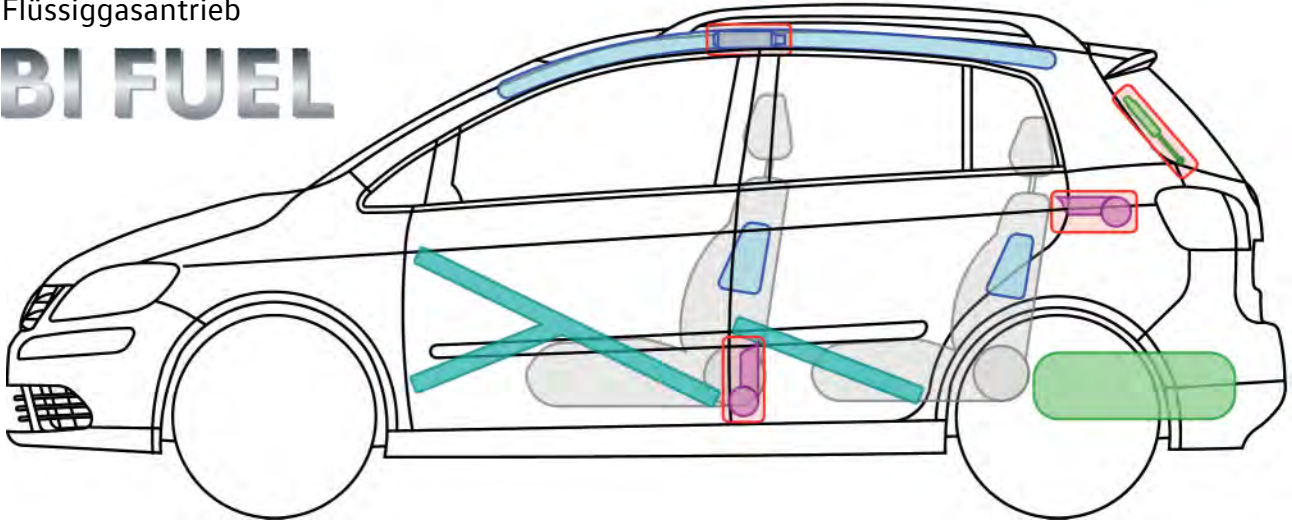





Flüssiggasantrieb

BI FUEL



Legende

	Airbag		Karosserie-Verstärkung		Steuergerät		Gastank
	Gas-generator				12V-Batterie		Sicherheits-ventil
	Gurtstraffer		Gasdruck-dämpfer		Kraftstoff-tank		



Golf 6 Plus

(BiFuel, ab 2009)



Hinweise zur Flüssiggasanlage

Der Gastank der Flüssiggasanlage des Golf 6 Plus BiFuel hat keine mechanische, manuelle Absperrmöglichkeit!



Der Flüssiggastank in der Reserveradmulde

1. Flüssiggastank lokalisieren

- Er ist unter dem Ladeboden in der Reserveradmulde montiert.
- Der Gastank verfügt nur über ein elektromagnetisches Absperrventil, das stromlos geschlossen ist.







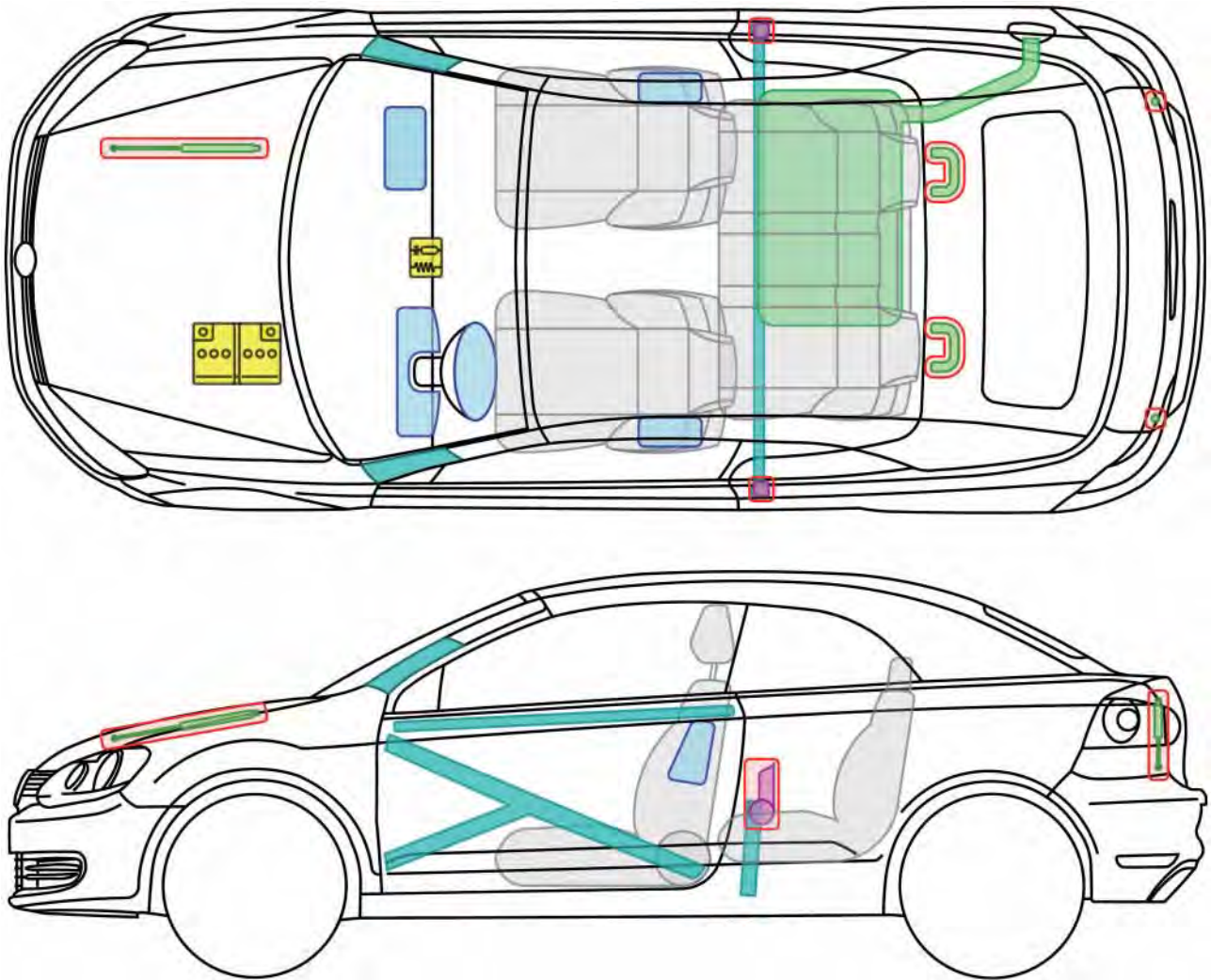



Golf 6

(Cabriolet, ab 2011)



Legende

	Airbag		Karosserie-Verstärkung		Steuergerät
			Überroll-schutz		12V-Batterie
	Gurtstraffer		Gasdruck-dämpfer		Kraftstoff-tank

G

Golf 6 (Cabriolet, ab 2011)







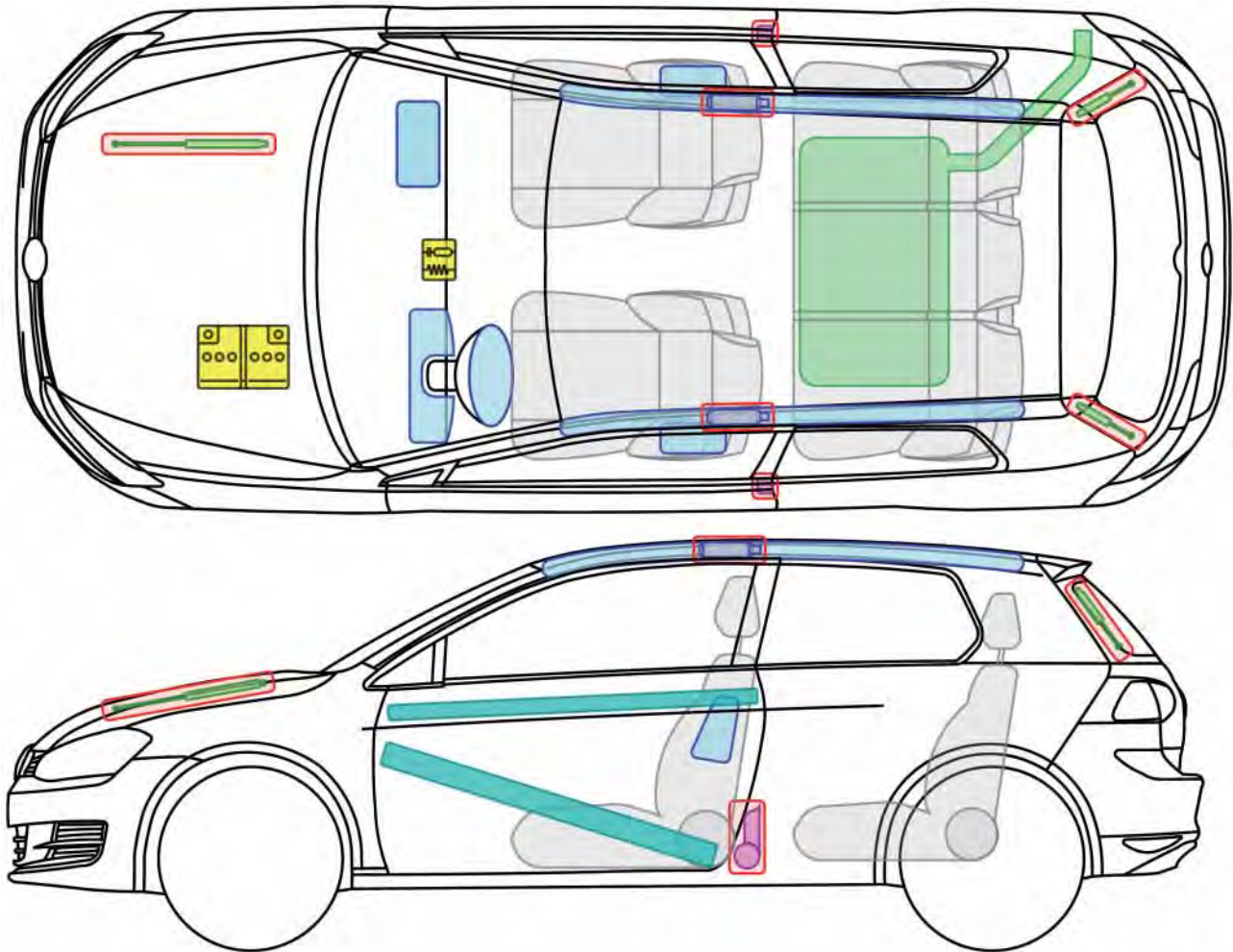



Golf 7

(3-Türer, ab 2012)



Legende

	Airbag		Karosserie-Verstärkung		Steuergerät
	Gas-generator				12V-Batterie
	Gurtstraffer		Gasdruck-dämpfer		Kraftstoff-tank







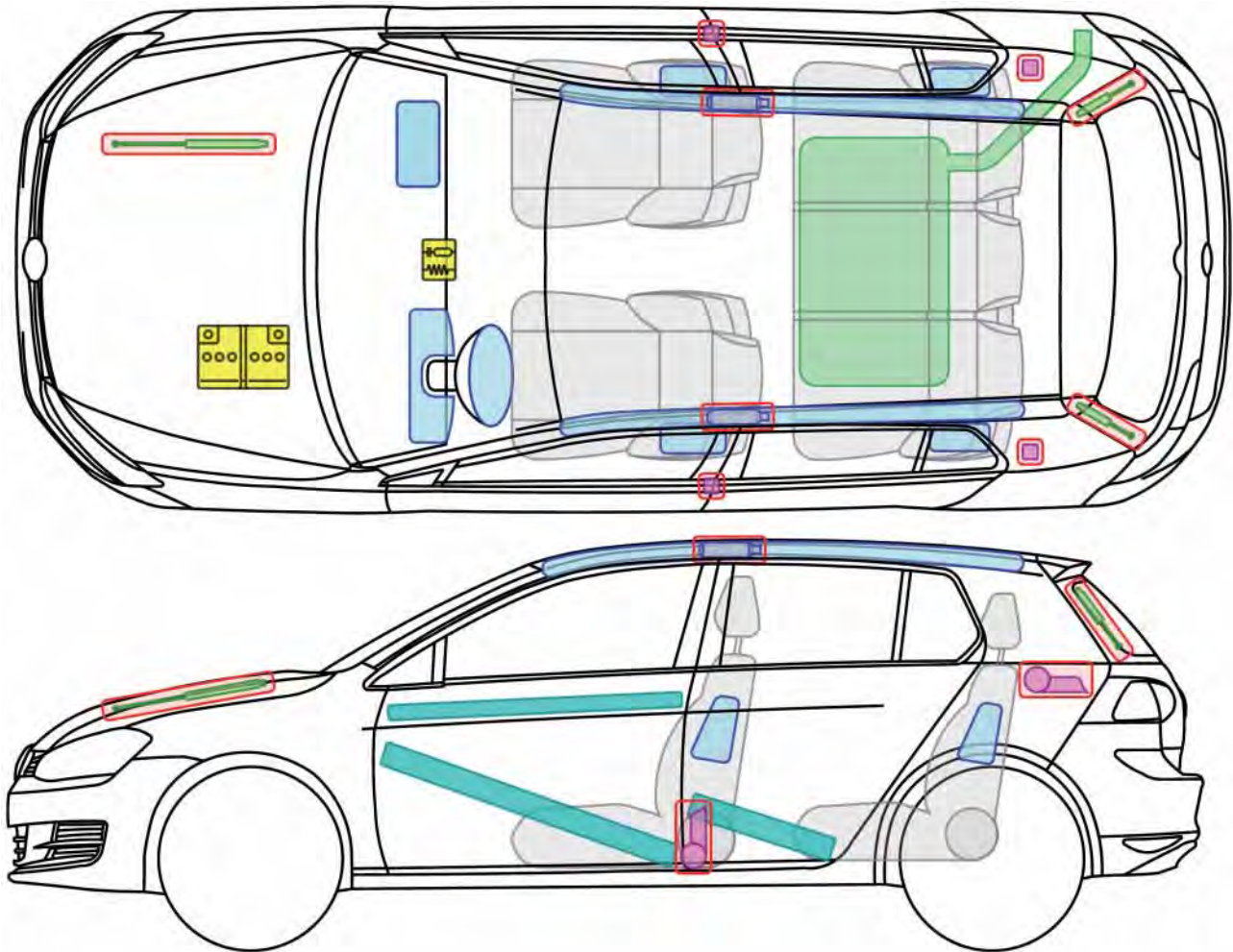



Golf 7

(5-Türer, ab 2012)



Legende

	Airbag		Karosserie-Verstärkung		Steuergerät
	Gas-generator				12V-Batterie
	Gurtstraffer		Gasdruck-dämpfer		Kraftstoff-tank







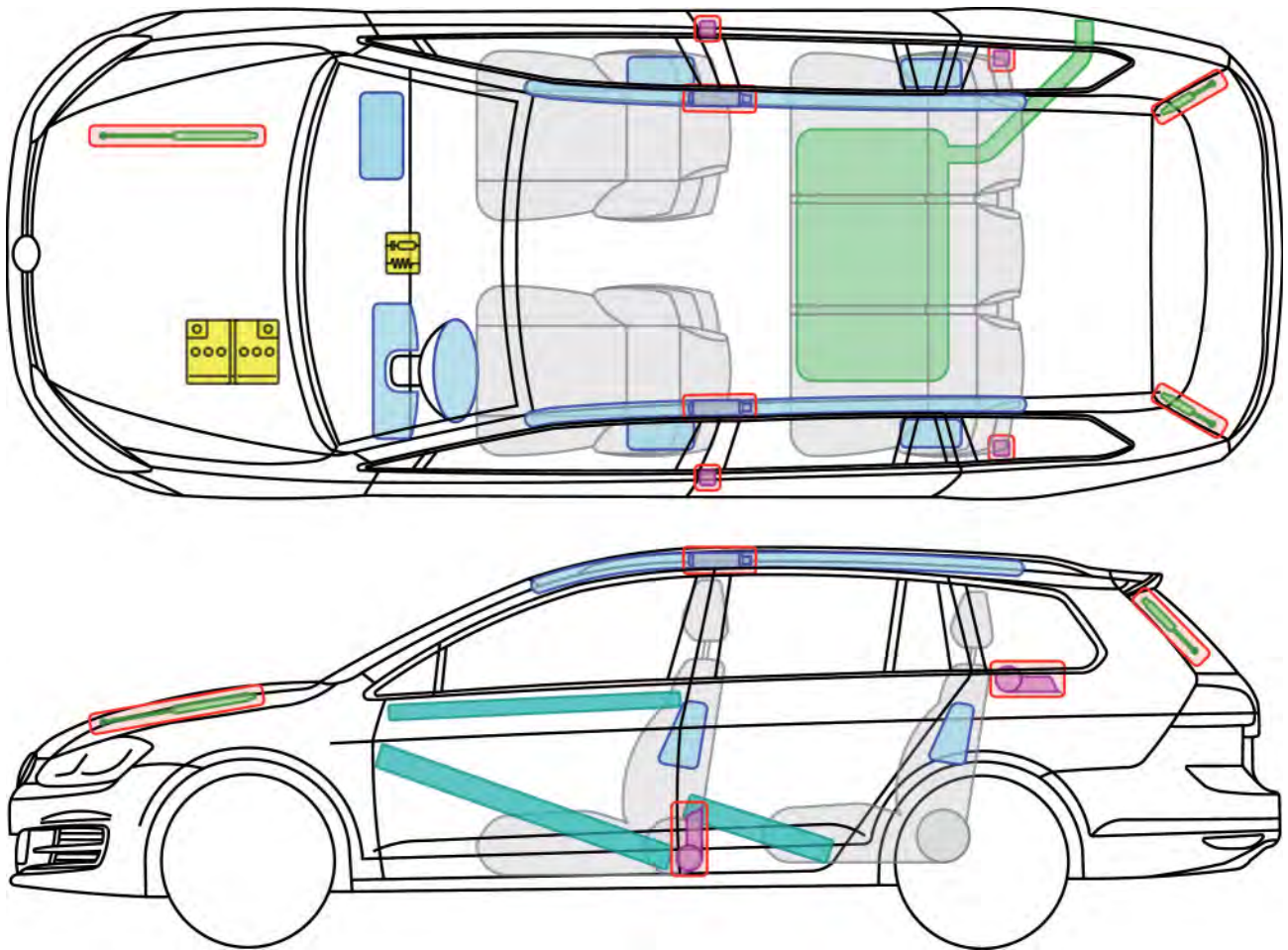



Golf 7

(Variant, ab 2013)



Legende

	Airbag		Karosserie-Verstärkung		Steuergerät	
	Gas-generator				12V-Batterie	
	Gurtstraffer		Gasdruck-dämpfer		Kraftstoff-tank	



Golf 7 TGI

(5-Türer, ab 2013)

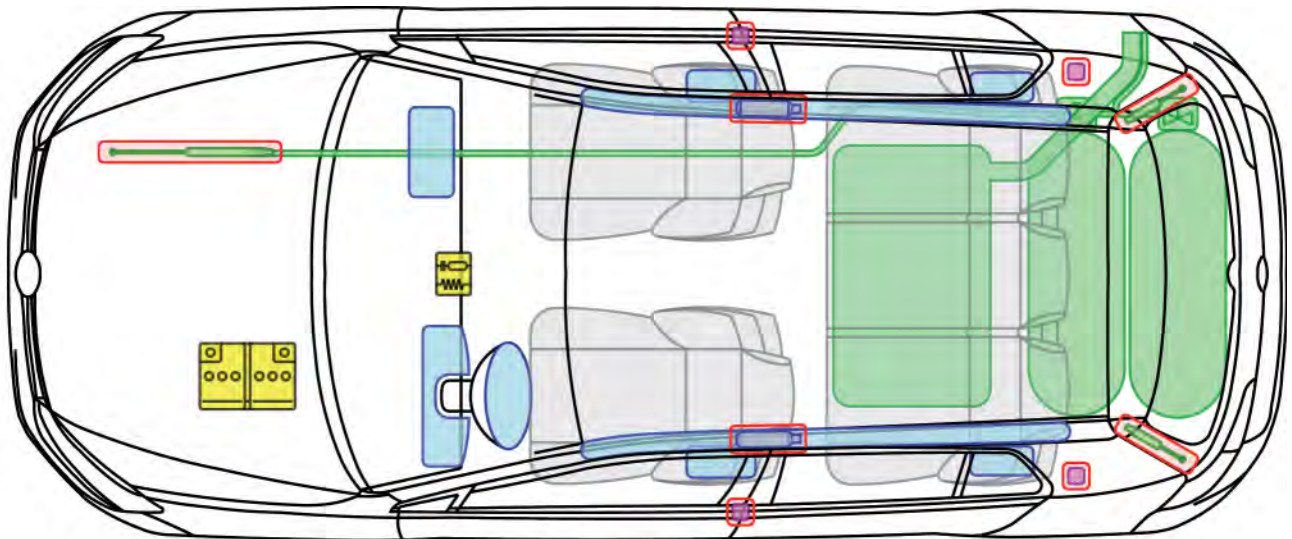





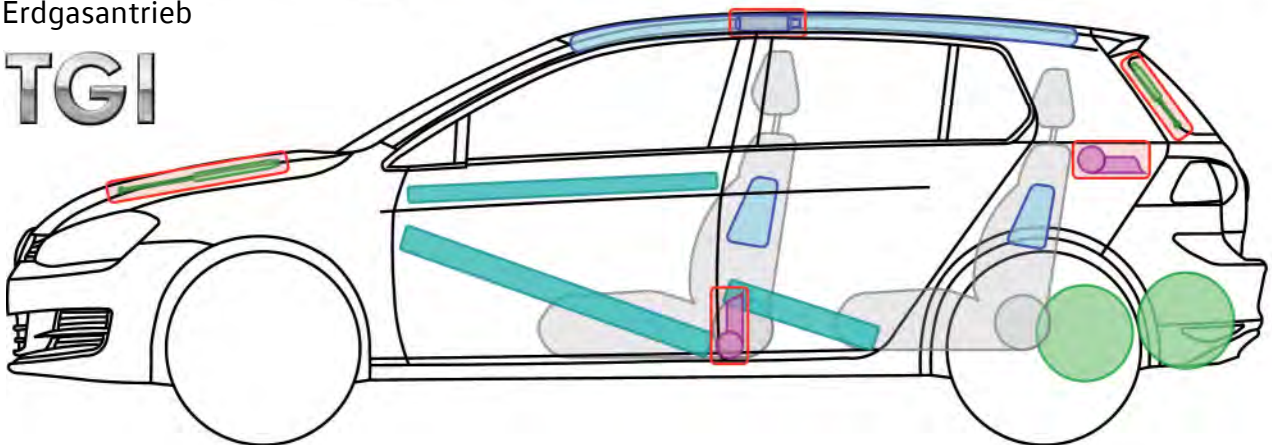





Erdgasantrieb

TGI



Legende

	Airbag		Karosserie-Verstärkung		Steuergerät		Gastank
	Gas-generator				12V-Batterie		Sicherheits-ventil
	Gurtstraffer		Gasdruck-dämpfer		Kraftstoff-tank		



Golf 7 TGI

(5-Türer, ab 2013)



Hinweise zur Erdgasanlage

Gastanks manuell absperren (bei Gasgeruch bzw. Austritt von Erdgas)

1. Zugang zu den Erdgastanks

- Der Zugang zu den Tanks erfolgt vom Unterboden aus.
- Die Gastanks sind durch eine Kunststoffabdeckung verkleidet. Um an die Erdgastanks zu gelangen, muss diese Abdeckung mit geeigneten Mitteln entfernt werden, ohne die darunter liegenden Bauteile der Gasanlage zu beschädigen.



elektromagnetische Absperrventile an den Gastanks

2. Absperrhähne lokalisieren

- Jeder Gastank besitzt ein eigenes Flaschenventil mit einem manuellen Absperrhahn.
- Falls einsatzbedingt erforderlich muss jeder Gastank separat abgesperrt werden.



manueller Absperrhahn am Fuß des Flaschenventils.

3. Gastank von Hand schließen

- Falls einsatzbedingt erforderlich muss jeder Gastank separat abgesperrt werden.
- Mit einem 5er-Maul- bzw. Ringschlüssel lässt sich das manuelle Absperrventil am Vierkant durch Drehen im Uhrzeigersinn bis zum Anschlag des Ventils verschließen.



Golf 7 TGI

(Variant, ab 2014)

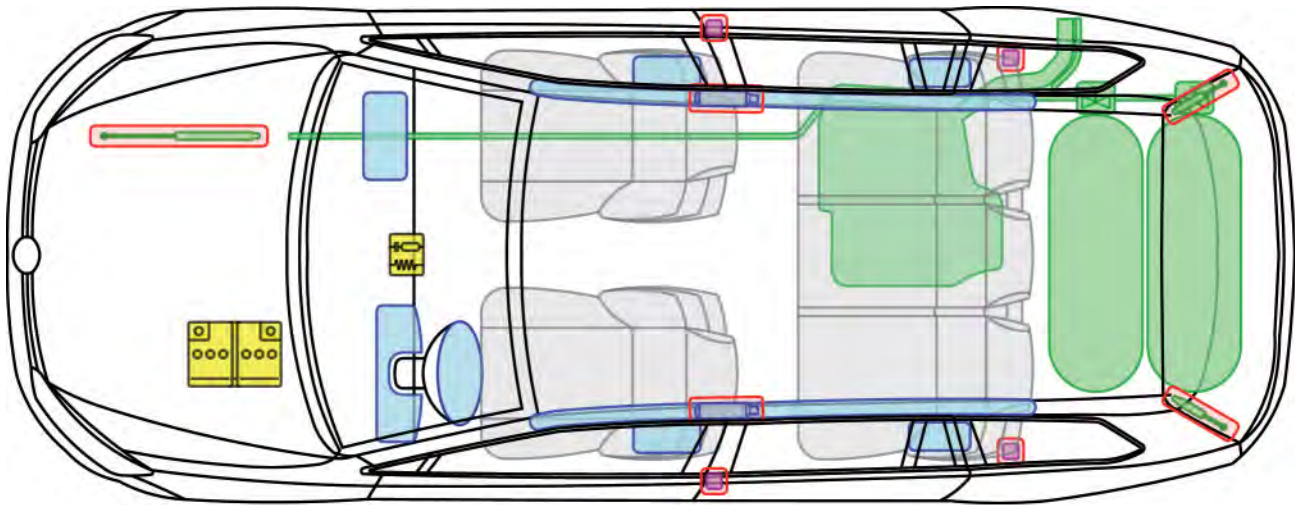





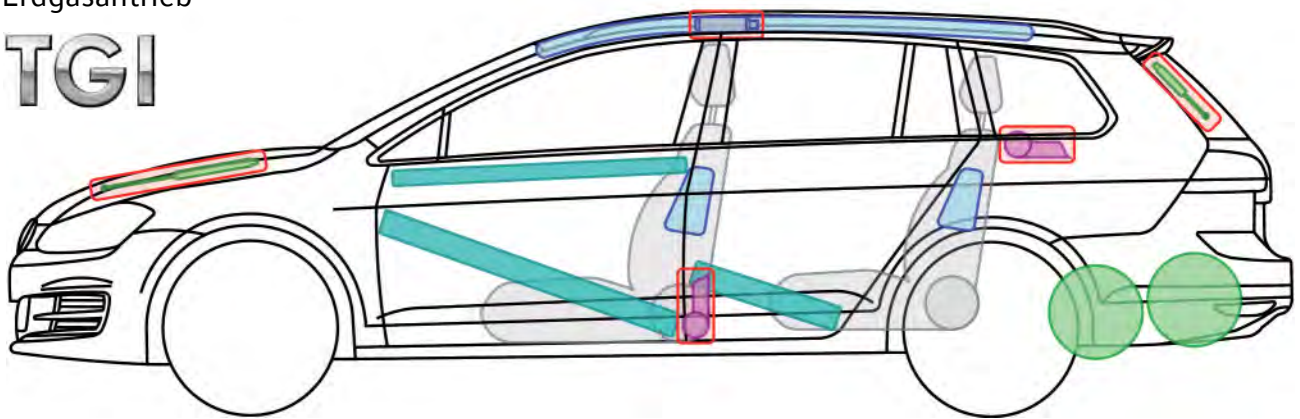





Erdgasantrieb

TGI



Legende

	Airbag		Karosserie-Verstärkung		Steuergerät		Gastank
	Gas-generator				12V-Batterie		Sicherheits-ventil
	Gurtstraffer		Gasdruck-dämpfer		Kraftstoff-tank		



Hinweise zur Erdgasanlage

Gastanks manuell absperren (bei Gasgeruch bzw. Austritt von Erdgas)

1. Zugang zu den Erdgastanks

- Der Zugang zu den Tanks erfolgt vom Unterboden aus.
- Die Gastanks sind durch eine Kunststoffabdeckung verkleidet. Um an die Erdgastanks zu gelangen, muss diese Abdeckung mit geeigneten Mitteln entfernt werden, ohne die darunter liegenden Bauteile der Gasanlage zu beschädigen.



elektromagnetische Absperrventile an den Gastanks

2. Absperrhähne lokalisieren

- Jeder Gastank besitzt ein eigenes Flaschenventil mit einem manuellen Absperrhahn.
- Falls einsatzbedingt erforderlich muss jeder Gastank separat abgesperrt werden.



manueller Absperrhahn am Fuß des Flaschenventils.

3. Gastank von Hand schließen

- Falls einsatzbedingt erforderlich muss jeder Gastank separat abgesperrt werden.
- Mit einem 5er-Maul- bzw. Ringschlüssel lässt sich das manuelle Absperrventil am Vierkant durch Drehen im Uhrzeigersinn bis zum Anschlag des Ventils verschließen.







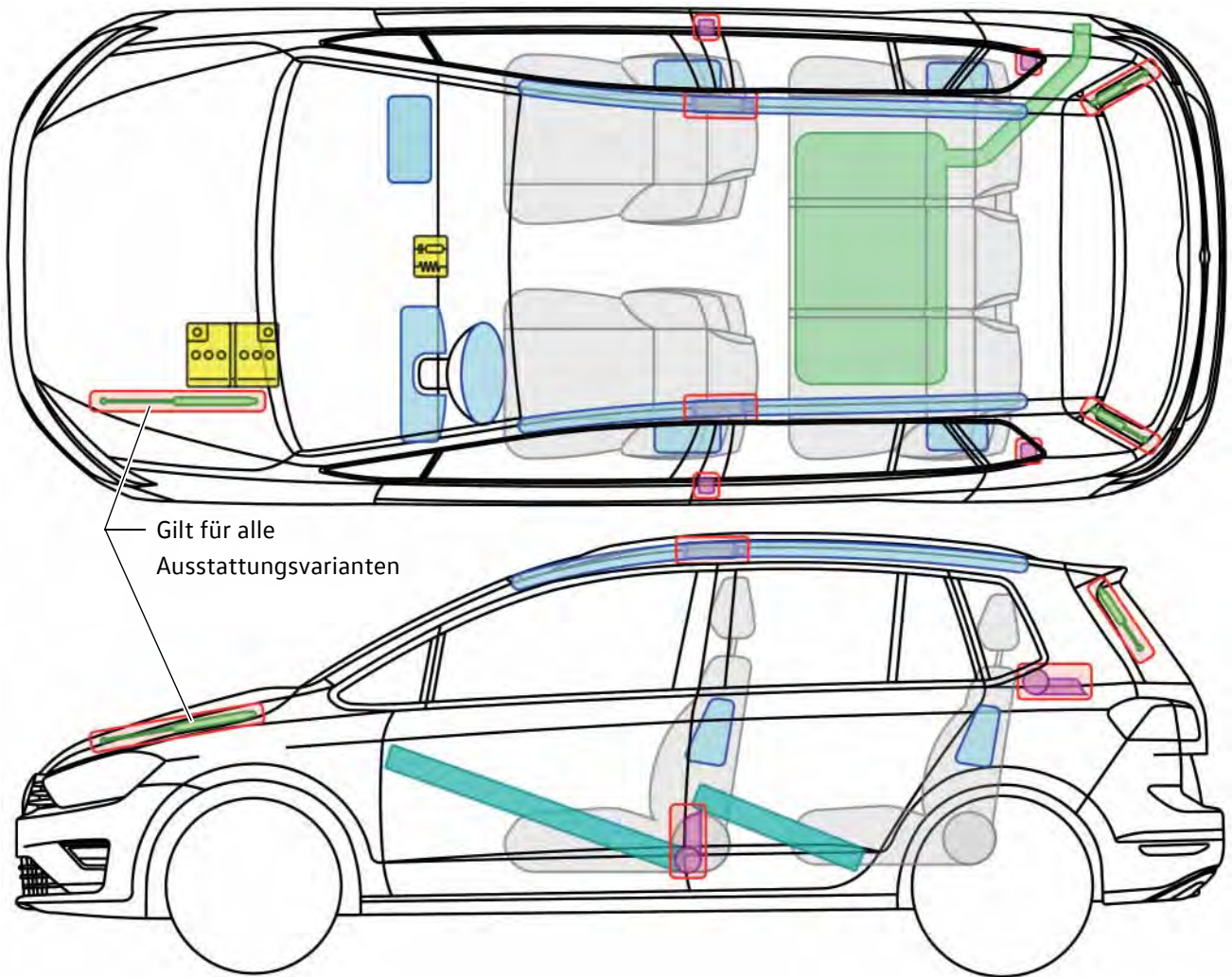



Golf 7

(Sportsvan, ab 2014)



Legende

	Airbag		Karosserie-Verstärkung		Steuergerät
	Gas-generator				12V-Batterie
	Gurtstraffer		Gasdruck-dämpfer		Kraftstoff-tank



e-Golf 7 (ab 2014)

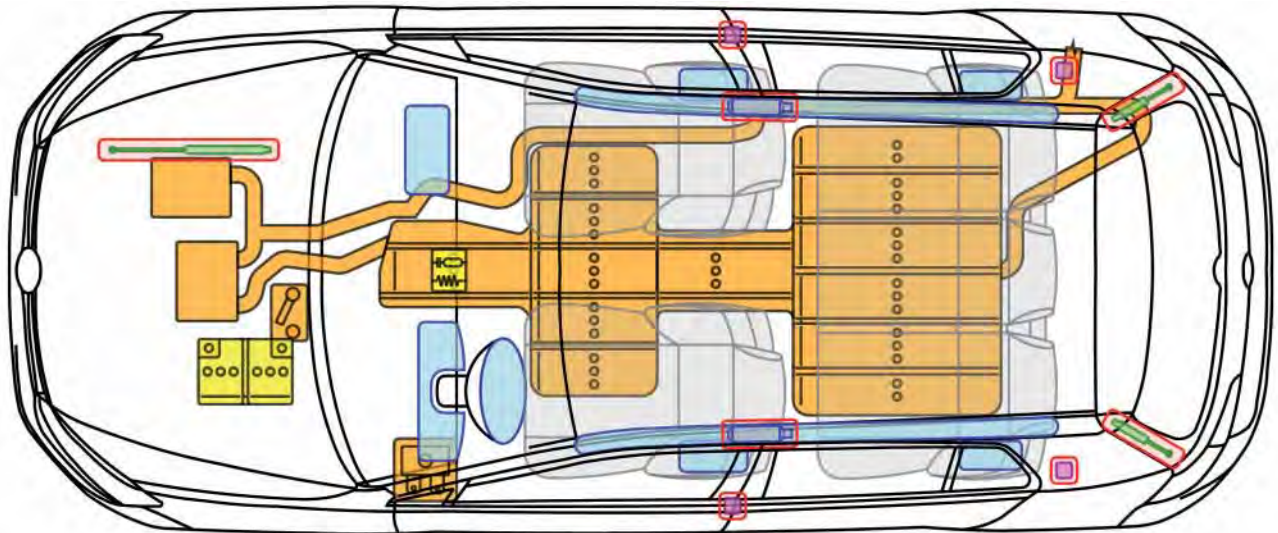





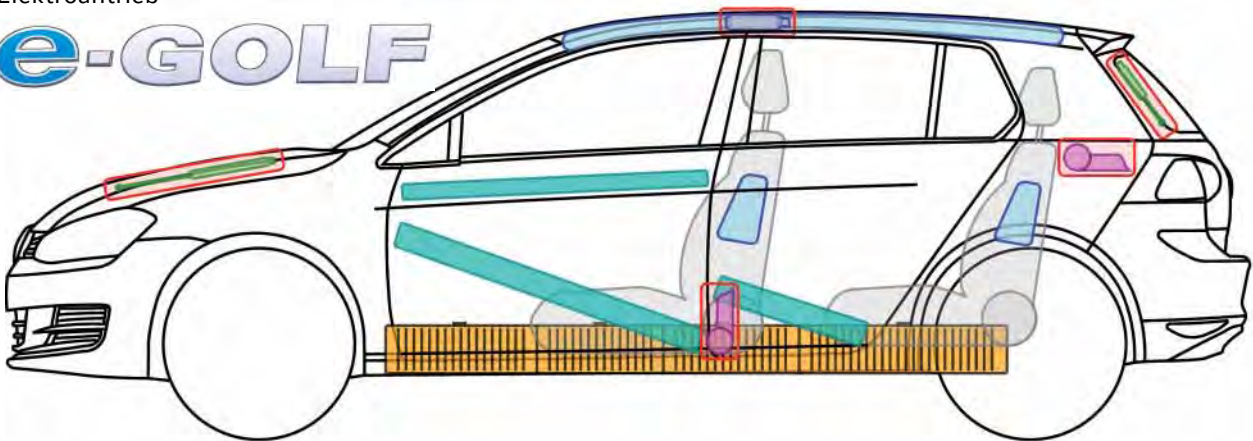







Elektroantrieb

e-GOLF



Legende

	Airbag		Karosserie-Verstärkung		Steuergerät		Hochvolt-batterie
	Gas-generator		Sicherungs-träger		12V-Batterie		Hochvolt-komponente/-leitung
	Gurtstraffer		Gasdruck-dämpfer		Kraftstoff-tank		Trennstelle für Hochvolt



e-Golf 7 (ab 2014)



Fahrzeugidentifizierung

Designleuchten
im Stoßfänger

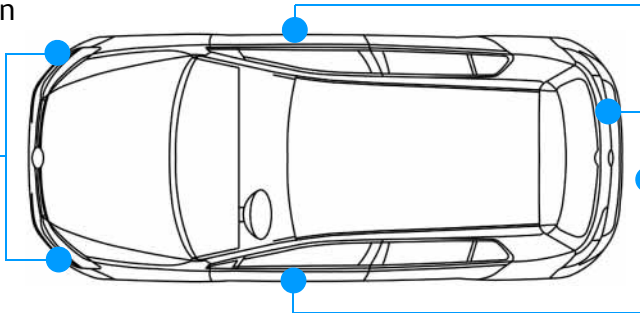

e-GOLF

Schriftzug auf den Türen und
auf der Heckklappe

Fahrzeug gegen Wegrollen sichern

1. Gangwahlhebel in Stellung „P“ bringen.
2. Feststellbremse betätigen.

Antrieb und Hochvoltsystem deaktivieren

Antrieb und Hochvoltsystem deaktivieren

(Zündung und Sicherungsträger im Innenraum zugänglich)



1. Zündschlüssel in „AUS-Stellung“ drehen
und abziehen oder Start-Stop-Taste drücken.



Die passiven Sicherheitssysteme wie Airbags und Gurtstraffer sind nach Ablauf der Entladungszeit des Airbagsteuergerätes von ca. 4 Sekunden durch das Drehen des Zündschlüssels in die Stellung „AUS“ deaktiviert. Vor Ablauf der Entladungszeit besteht eine Gefahr der Airbagauslösung aufgrund der Beschädigung des Airbagsystems.

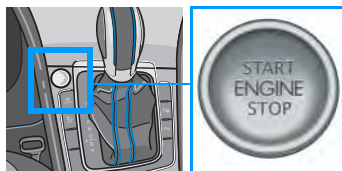

2. Ablagefach über dem Sicherungsträger der Schalttafel links entfernen.
Gekennzeichnete Sicherung herausziehen.
(gelbe Fahne)

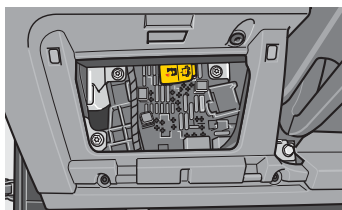

Das Hochvoltsystem ist nach dem Deaktivieren innerhalb von ca. 20 Sekunden spannungsfrei. Die passiven Sicherheitssysteme wie Airbags und Gurtstraffer sind dann deaktiviert.





Golf 7 GTE



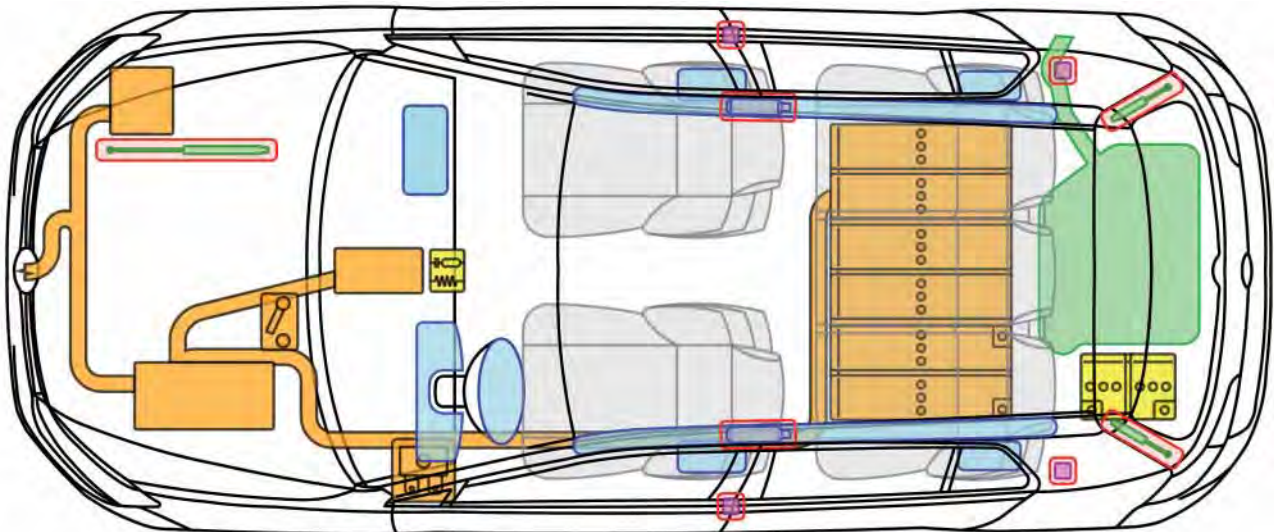



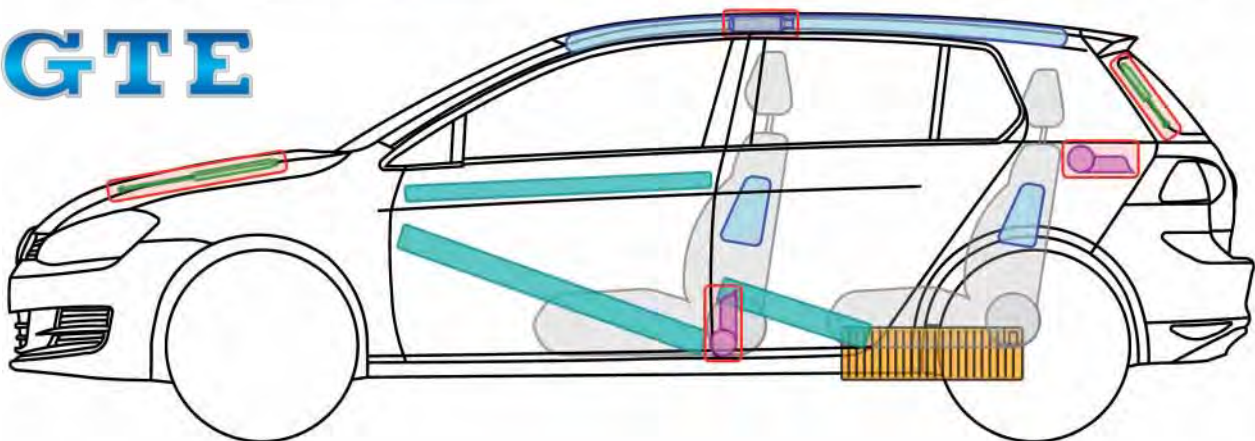





(ab 2014)



GTE



Legende

	Airbag		Karosserie-Verstärkung		Steuergerät		Hochvolt-batterie
	Gas-generator		Sicherungs-träger		12V-Batterie		Hochvolt-komponente/-leitung
	Gurtstraffer		Gasdruck-dämpfer		Kraftstoff-tank		Trennstelle für Hochvolt



Golf 7 GTE

(ab 2014)



Fahrzeugidentifizierung

Designleuchten
im Stoßfänger



GTE

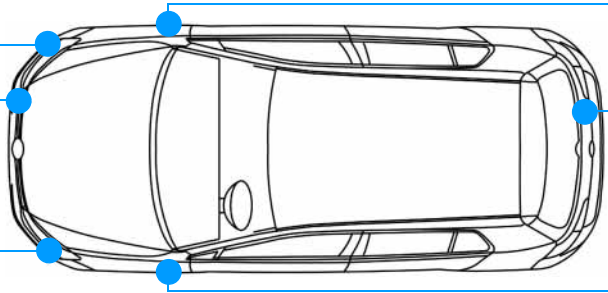

GTE

Fahrzeug gegen Wegrollen sichern

1. Gangwahlhebel in Stellung „P“ bringen.
2. Feststellbremse betätigen.

Antrieb und Hochvoltsystem deaktivieren

Zündung und Sicherungsträger im Innenraum zugänglich



1. Zündschlüssel in „AUS-Stellung“ drehen und abziehen oder Start-Stop-Taste drücken.



Die passiven Sicherheitssysteme wie Airbags und Gurtstraffer sind nach Ablauf der Entladungszeit des Airbagsteuergerätes von ca. 4 Sekunden durch das Drehen des Zündschlüssels in die Stellung „AUS“ deaktiviert. Vor Ablauf der Entladungszeit besteht eine Gefahr der Airbagauslösung aufgrund der Beschädigung des Airbagsystems.

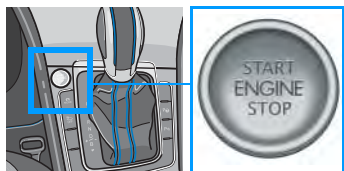

2. Ablagefach über dem Sicherungsträger der Schalttafel links entfernen. Gekennzeichnete Sicherung herausziehen. (gelbe Fahne)

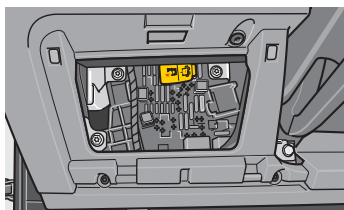

Das Hochvoltsystem ist nach dem Deaktivieren innerhalb von ca. 20 Sekunden spannungsfrei. Die passiven Sicherheitssysteme wie Airbags und Gurtstraffer sind dann deaktiviert.





Golf 7 GTE (ab 2014)



Antrieb und Hochvoltsystem deaktivieren

Motorraum und Kofferraum zugänglich

UND 12V-Bordnetzbatterie abklemmen



1. 12V-Bordnetzbatterie im Kofferraum lokalisieren.



2. 12V-Bordnetzbatterie am Minuspol mit geeignetem Werkzeug abtrennen.



Das Hochvoltsystem ist nach dem Deaktivieren innerhalb von ca. 20 Sekunden spannungsfrei. Die passiven Sicherheitssysteme wie Airbags und Gurtstraffer sind dann deaktiviert.

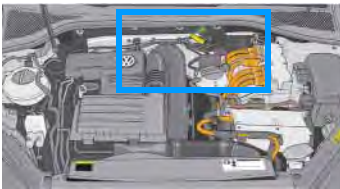

3. Rettungstrennstelle im Motorraum lokalisieren.

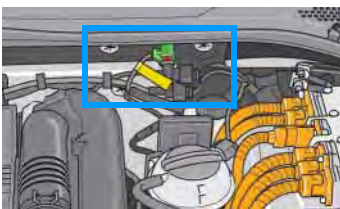

4. Rettungstrennstelle öffnen.
Vorgehensweise ist auf dem Label beschrieben!



Das Hochvoltsystem ist nach dem Deaktivieren innerhalb von ca. 20 Sekunden spannungsfrei. Die passiven Sicherheitssysteme wie Airbags und Gurtstraffer sind dann deaktiviert.



An der Ladesäule angeschlossenes Fahrzeug

Fahrzeug entriegeln. Das Ladekabel vom Fahrzeug trennen und ggf. bei schweren Unfällen das Hochvoltsystem des Fahrzeugs deaktivieren (siehe unter „Fahrzeug deaktivieren“)!



Jetta

(ab 2005)

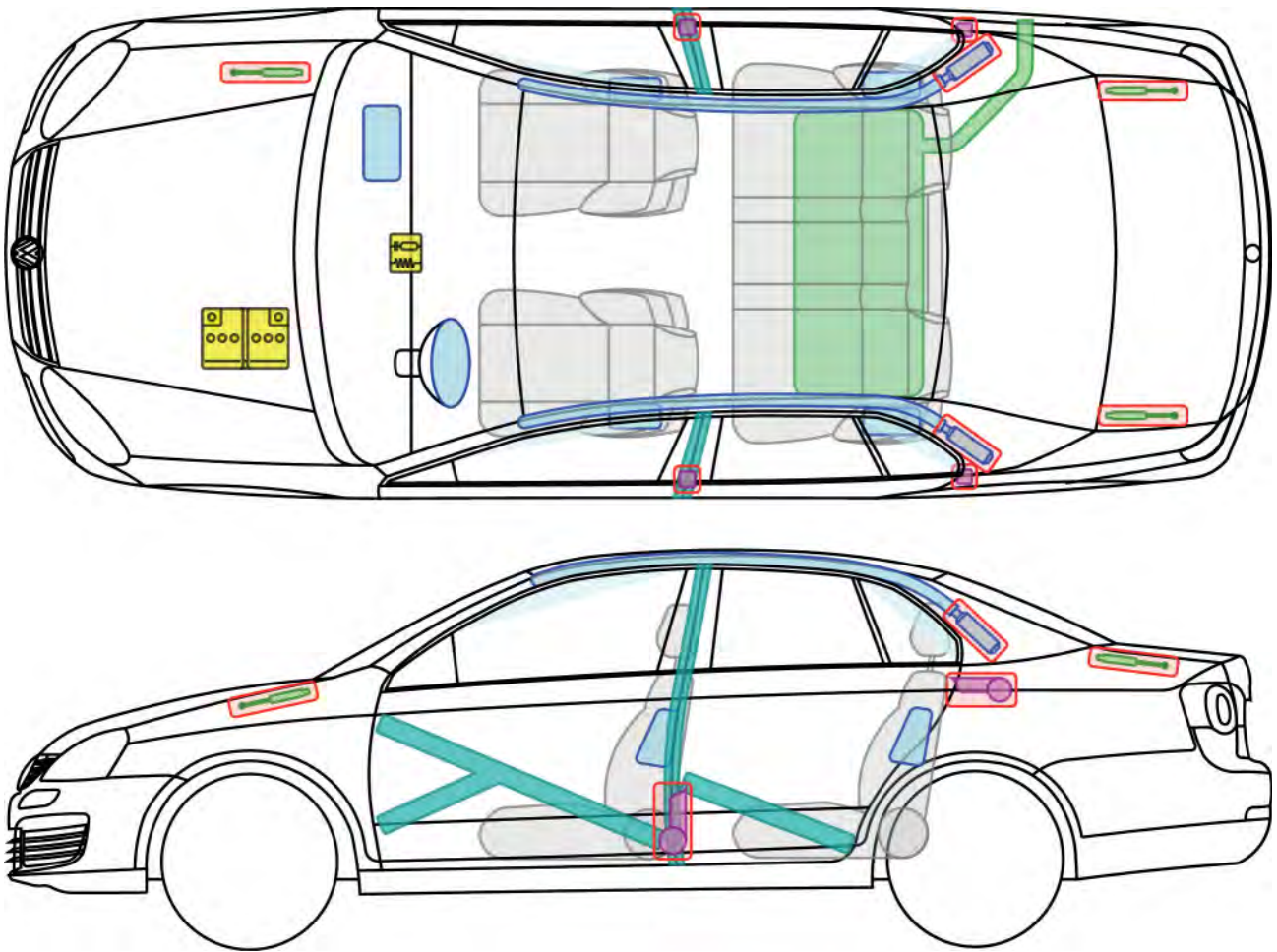

Legende

	Airbag		Karosserie-Verstärkung		Steuergerät
	Gas-generator				12V-Batterie
	Gurtstraffer		Gasdruck-dämpfer		Kraftstoff-tank







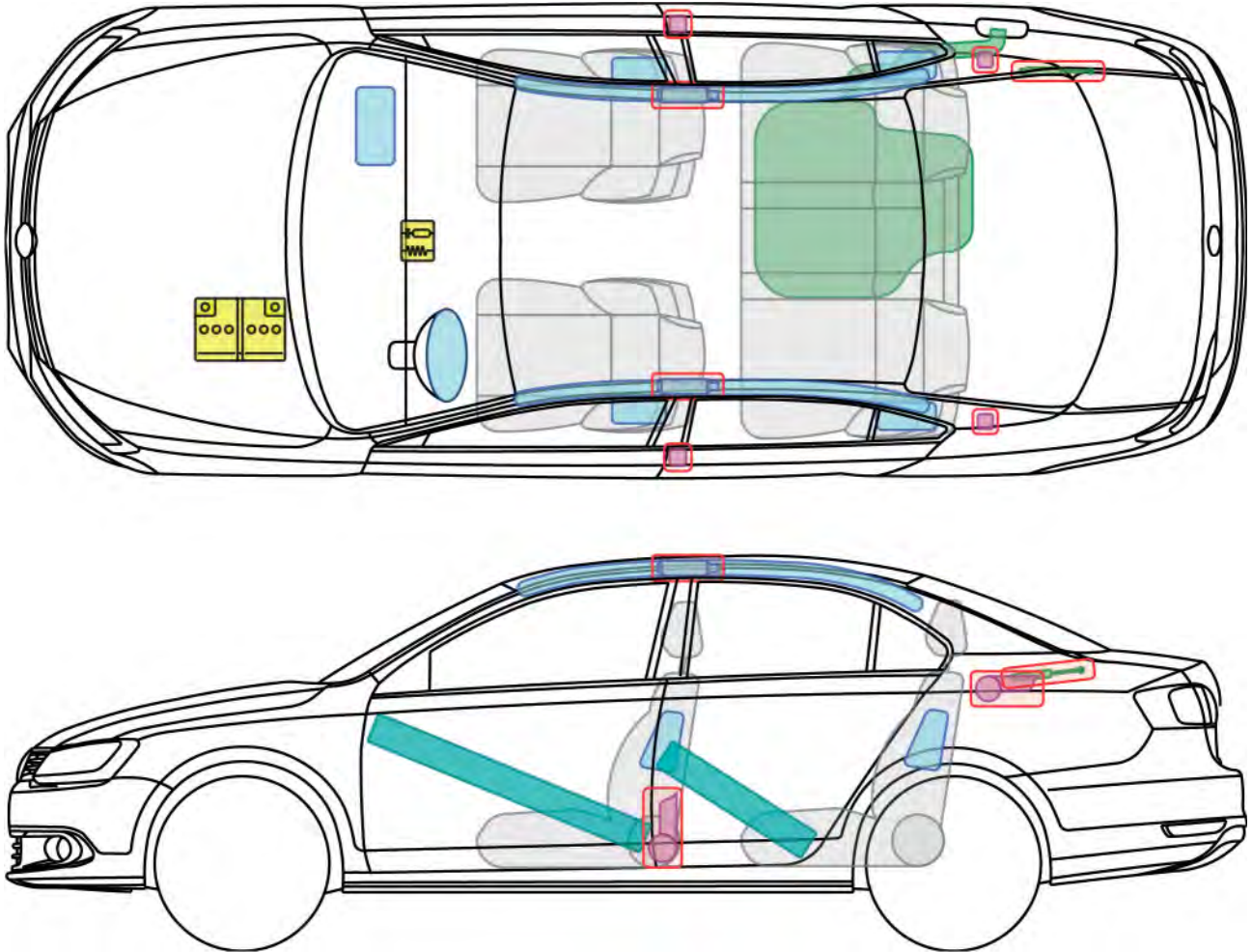



Jetta

(ab 2010)



Legende

	Airbag		Karosserie-Verstärkung		Steuergerät
	Gas-generator				12V-Batterie
	Gurtstraffer		Gasdruck-dämpfer		Kraftstoff-tank



Jetta

(Hybrid, ab 2012)

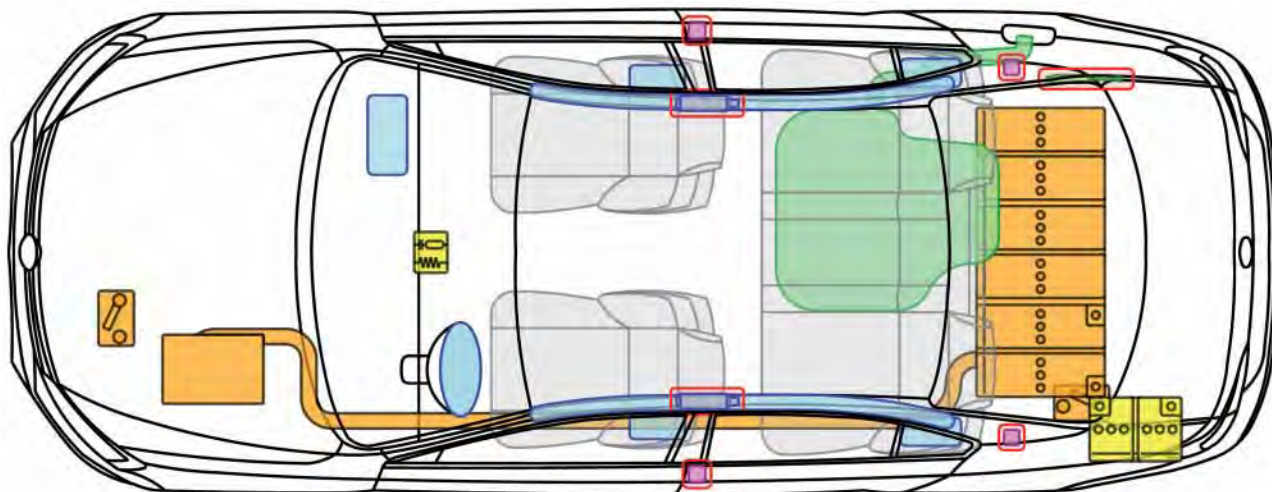





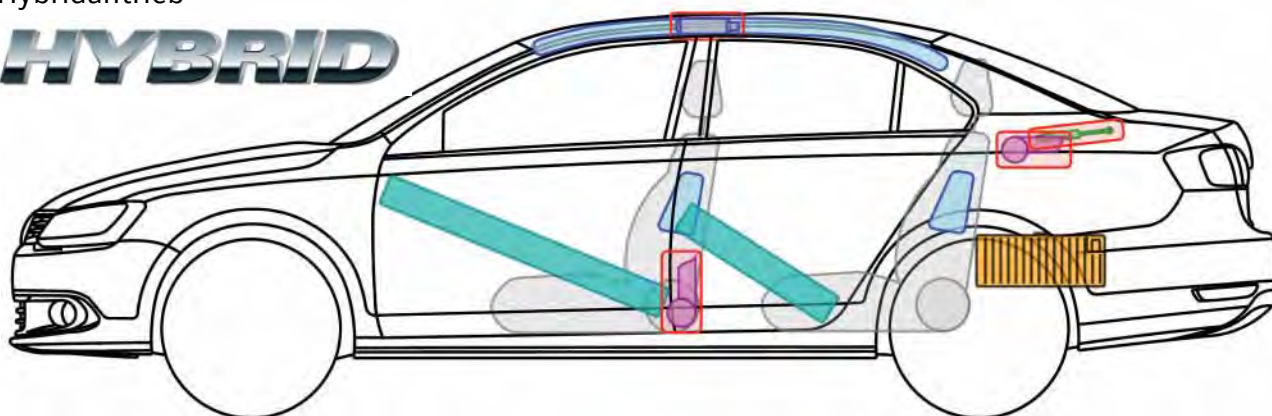





Hybridantrieb

HYBRID



Legende

	Airbag		Karosserie-Verstärkung		Steuergerät		Hochvolt-batterie
	Gas-generator				12V-Batterie		Hochvolt-leitung/-komponente
	Gurtstraffer		Gasdruck-dämpfer		Kraftstoff-tank		Trennstelle für Hochvolt



Jetta

(Hybrid, ab 2012)



Fahrzeugidentifizierung

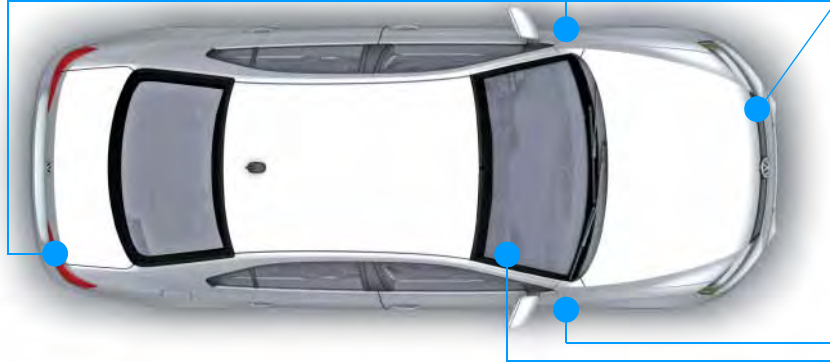

Designleiste Handschuhfach

Fahrzeug gegen Wegrollen sichern

Fahrzeug deaktivieren

Antrieb und Hochvoltsystem deaktivieren (Zündung und 12V-Batterie zugänglich)

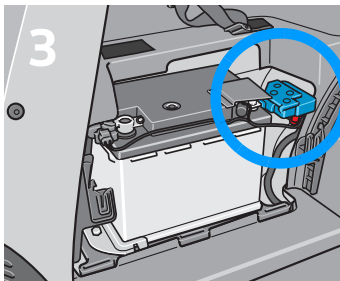
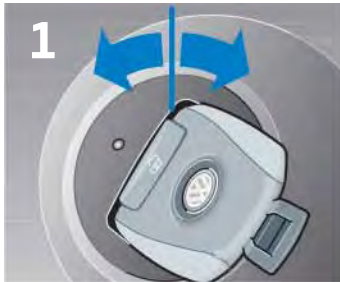

1. Zündschlüssel in „AUS-Stellung“ drehen oder

2. Start/Stop-Taster bis zur 2. Stufe durchdrücken oder

3. 12V-Batterie im Kofferraum links lokalisieren und abklemmen. Dabei beide Plusleitungen (rot) mit geeignetem Werkzeug abtrennen!



Werden nicht beide Plus-Leitungen getrennt, schaltet das Hochvoltsystem nicht sicher ab!

Deshalb grundsätzlich immer beide Plus-Leitungen trennen!

J

Jetta (Hybrid, ab 2012)



Jetta

(Hybrid, ab 2012)



Fahrzeug deaktivieren

Hochvoltsystem deaktivieren

(Zündung und 12V-Batterie NICHT zugänglich)

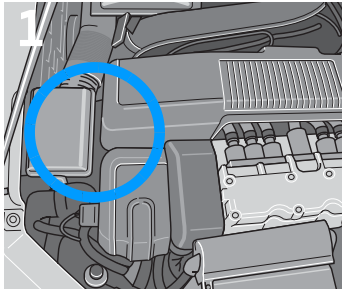

1. Zum Erreichen der gelb markierten Trennstelle im Motorraum die Designabdeckung des Motors entfernen.

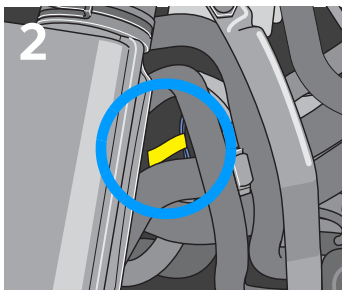

2. Gelb markierte Trennstelle lokalisieren

- Die zu trennende 12V-Leitung befindet sich auf Höhe des Luftfilters zwischen Kühler und Motorblock

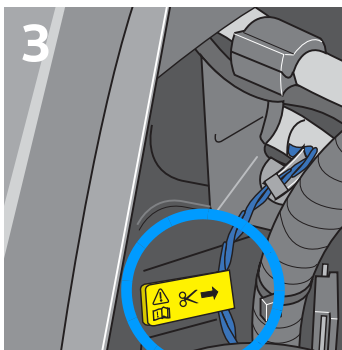

3. Leitung an der gelb markierten Trennstelle mit geeignetem Werkzeug durchschneiden.



Das Hochvoltsystem ist nach dem Deaktivieren innerhalb von ca. 20 Sekunden spannungsfrei. Die passiven Sicherheitssysteme wie Airbags und Gurtstraffer sind dann nicht deaktiviert.



Lupo



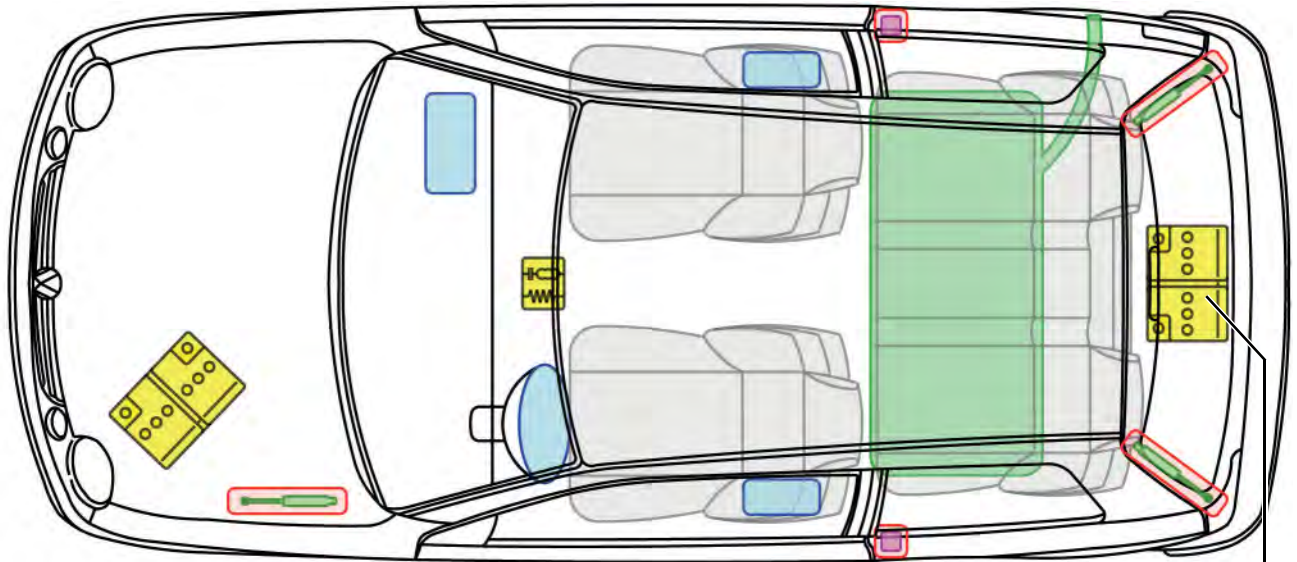

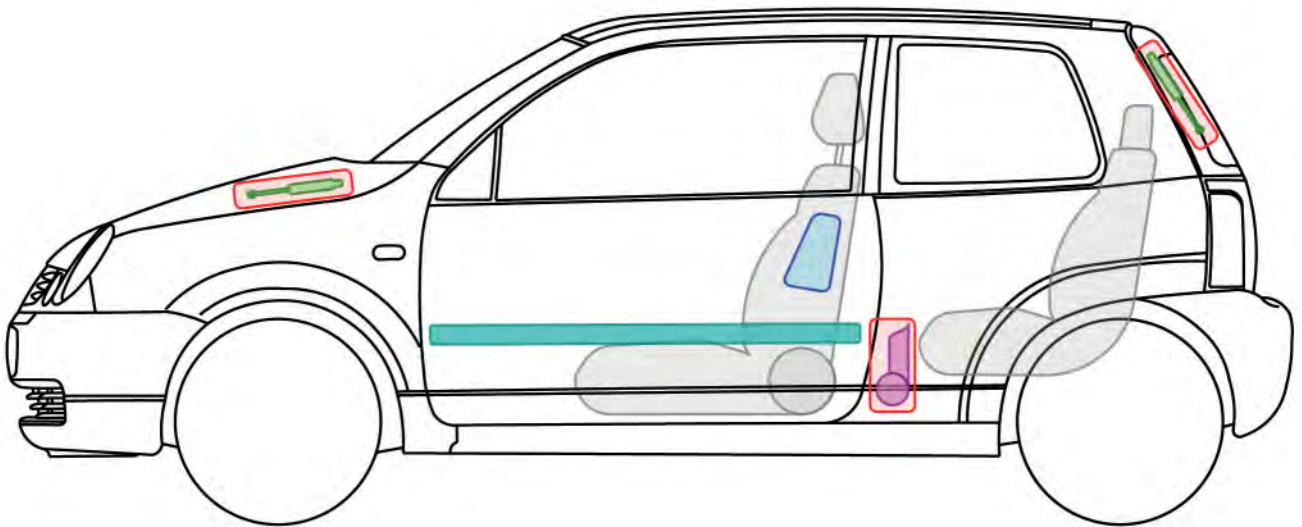

(ab 1998)



nur Lupo 3L und Lupo GTI



Legende

	Airbag		Karosserie-Verstärkung		Steuergerät	
					12V-Batterie	
	Gurtstraffer		Gasdruck-dämpfer		Kraftstoff-tank	







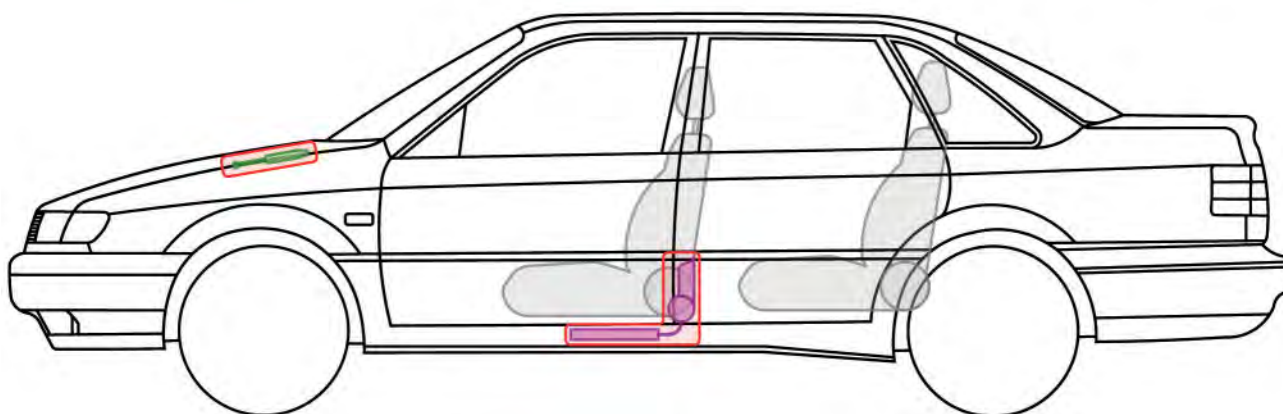
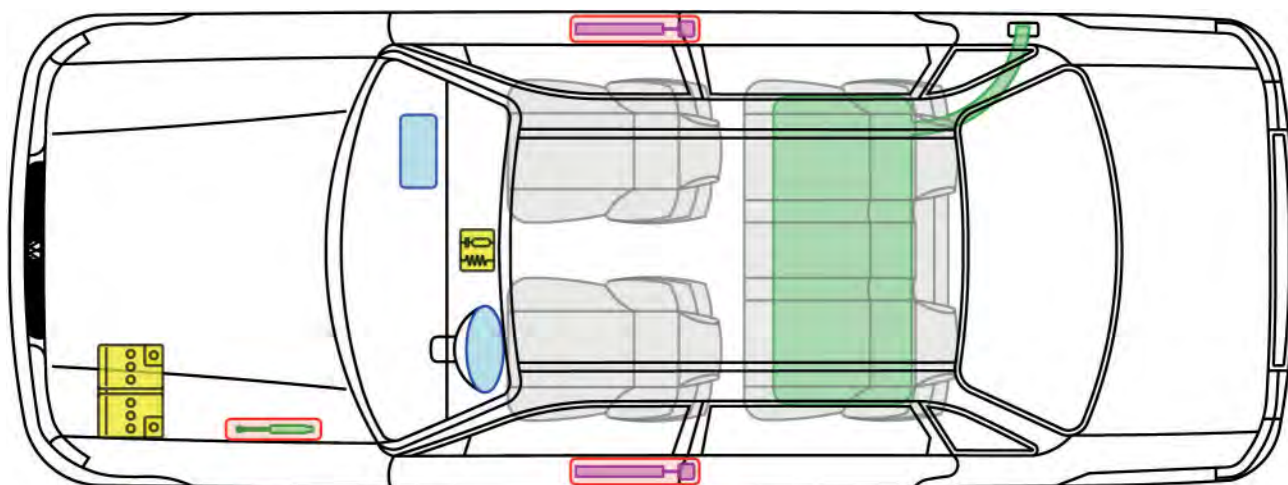

Passat B4

(Limousine, ab 1993)



Legende

	Airbag		Steuergerät
			12V-Batterie
	Gurtstraffer		Gasdruckdämpfer
			Kraftstofftank







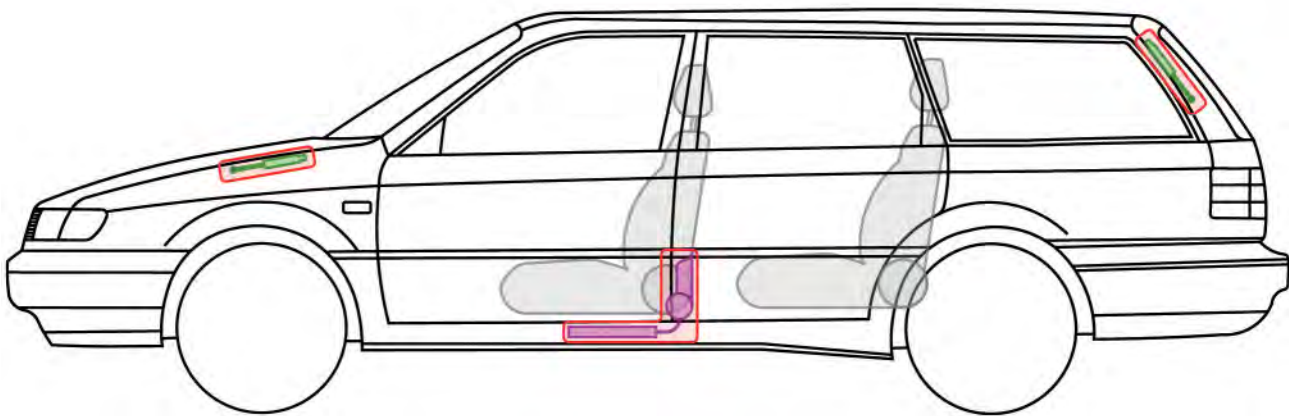
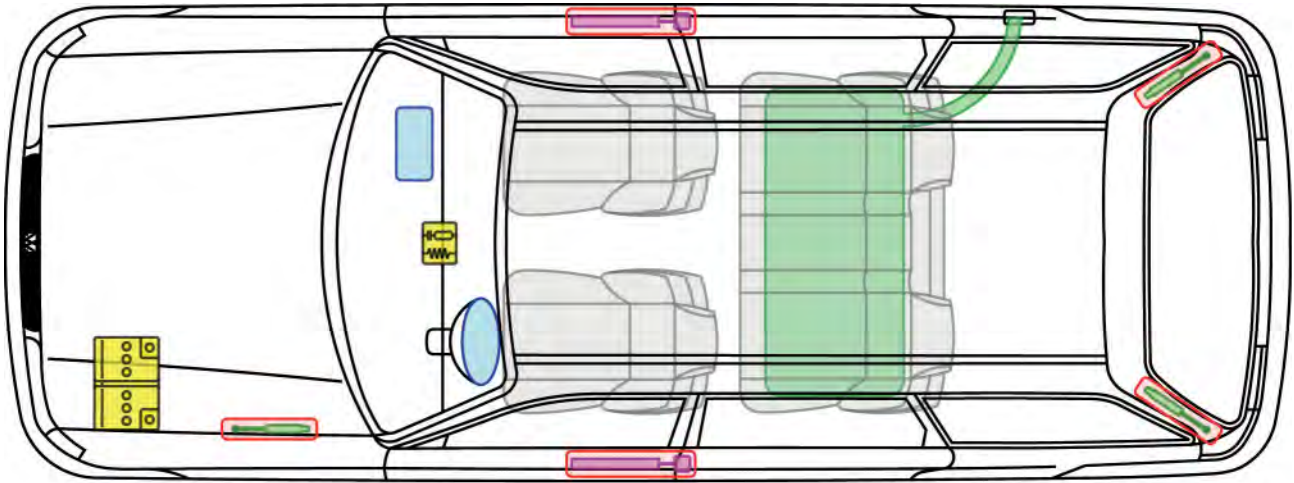

Passat B4

(Variant, ab 1993)



Legende

	Airbag		Steuergerät
			12V-Batterie
	Gurtstraffer		Gasdruckdämpfer
			Kraftstofftank



Passat B5

(Limousine, ab 1996)

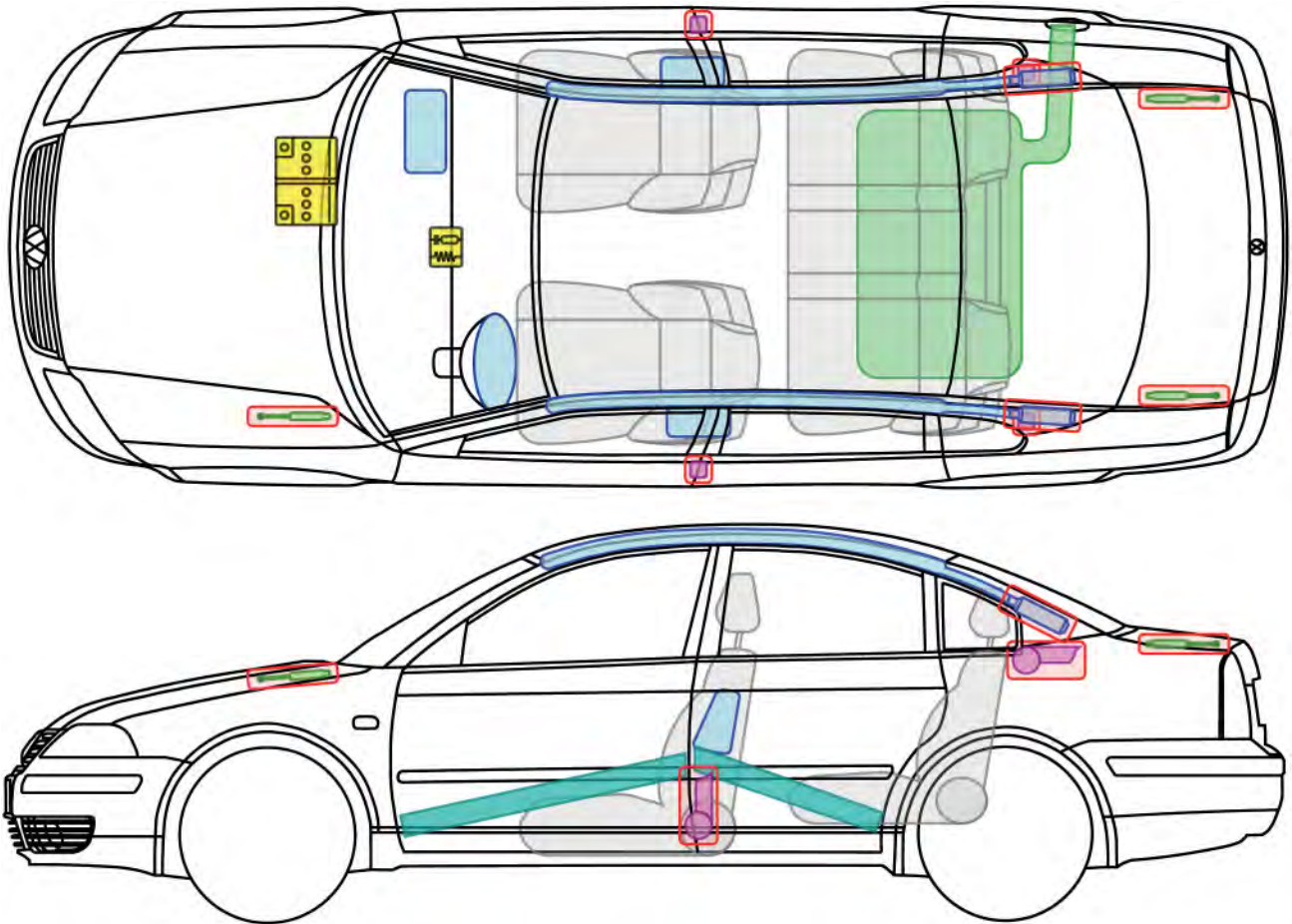

Legende

	Airbag		Karosserie-Verstärkung		Steuergerät
	Gas-generator				12V-Batterie
	Gurtstraffer		Gasdruck-dämpfer		Kraftstoff-tank







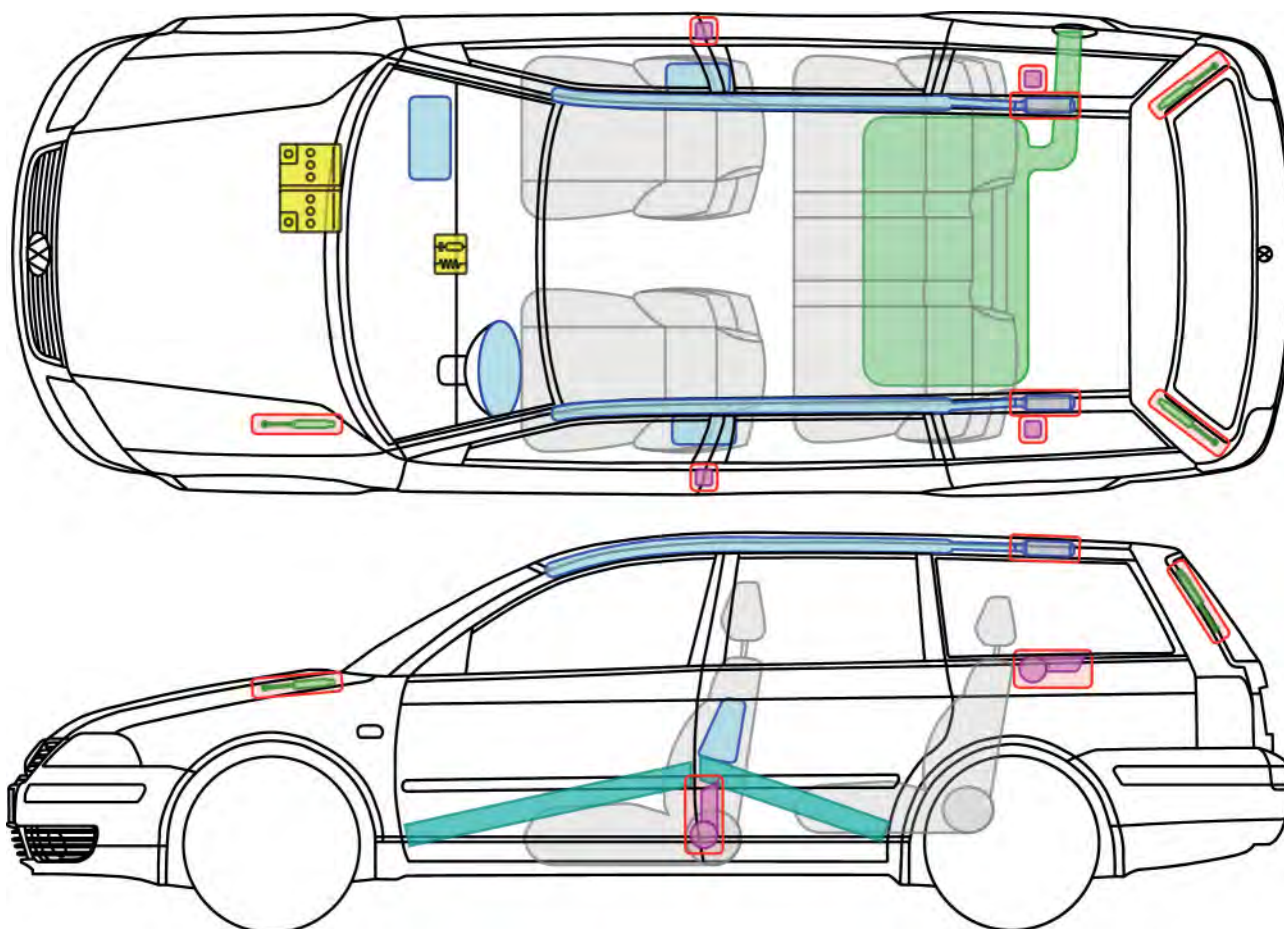

Passat B5

(Variant, ab 1997)

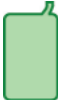

Legende

	Airbag		Karosserie-Verstärkung		Steuergerät
	Gas-generator				12V-Batterie
	Gurtstraffer		Gasdruck-dämpfer		Kraftstoff-tank



Passat B6



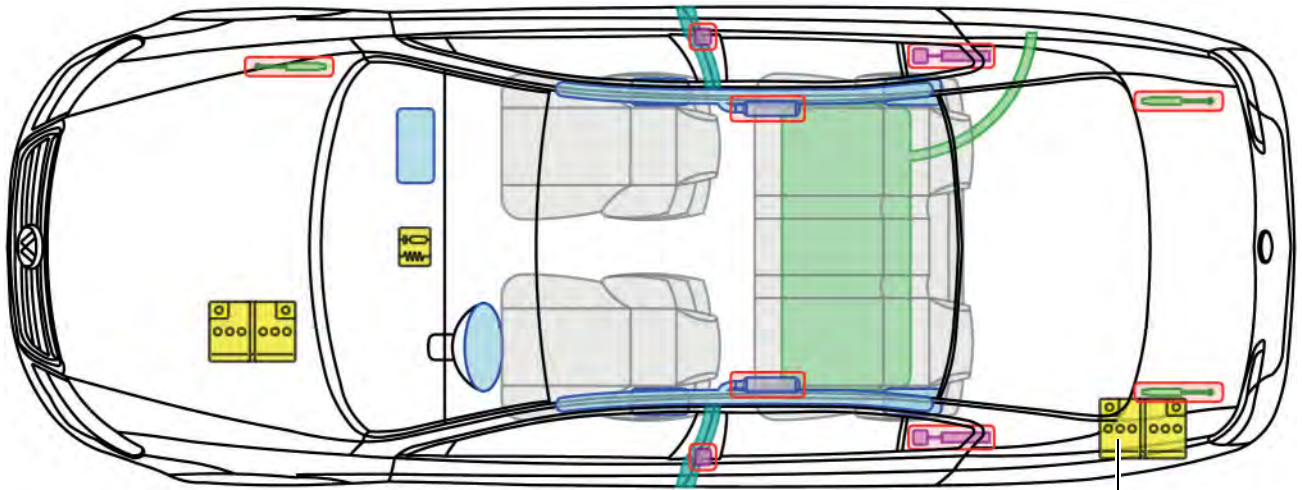



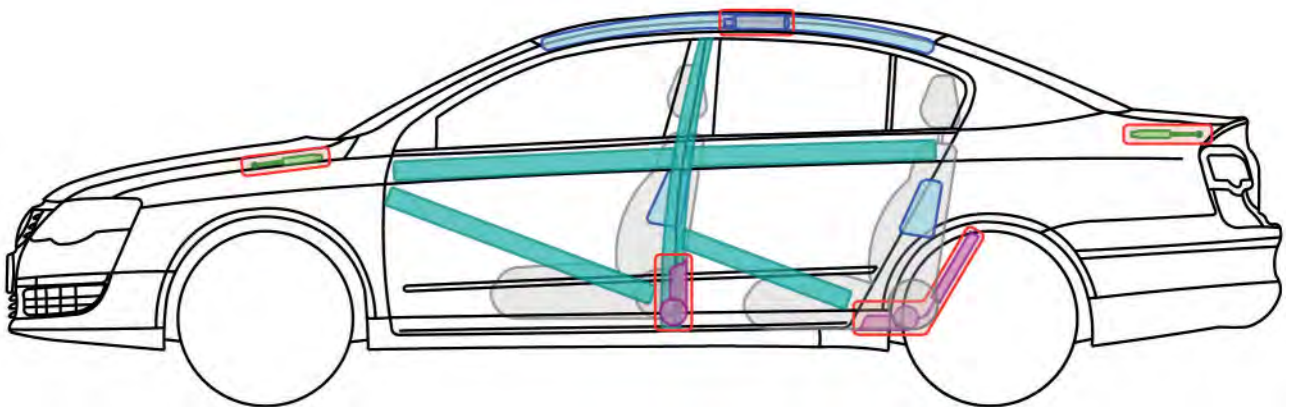

(Limousine, ab 2005)



als 2. Batterie nur Passat R36 sonst ausstattungsabhängige Zusatzbatterie



Legende

	Airbag		Karosserie-Verstärkung		Steuergerät	
	Gas-generator				12V-Batterie	
	Gurtstraffer		Gasdruck-dämpfer		Kraftstoff-tank	
						Gurtstraffer



Passat B6

(Limousine, ab 2005)



Fahrzeug deaktivieren

Batterie abklemmen (gilt nur bei Passat B6 R36)



1. Batterieabdeckung im Kofferraum entfernen

- Batterieabdeckung im Kofferraum auf der linken Fahrzeugseite lokalisieren
- Befestigungsschrauben lösen und Abdeckung abnehmen

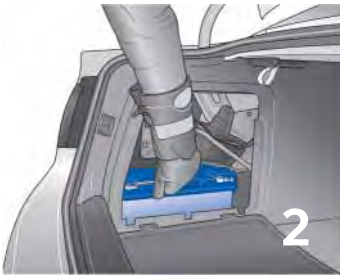

2. Masseanschluss (-) an der Batterie abklemmen



Passat B6



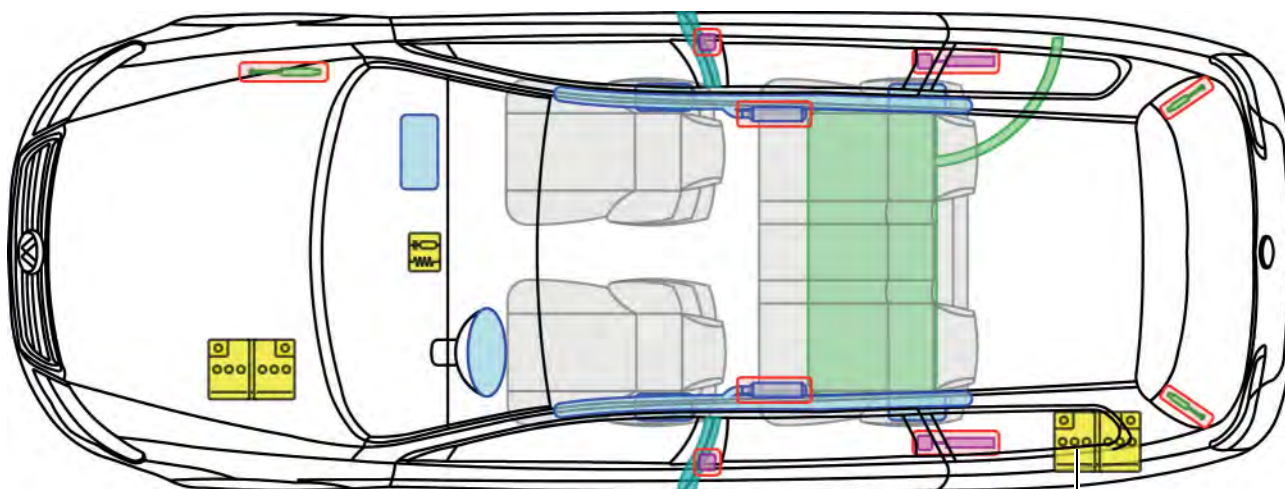



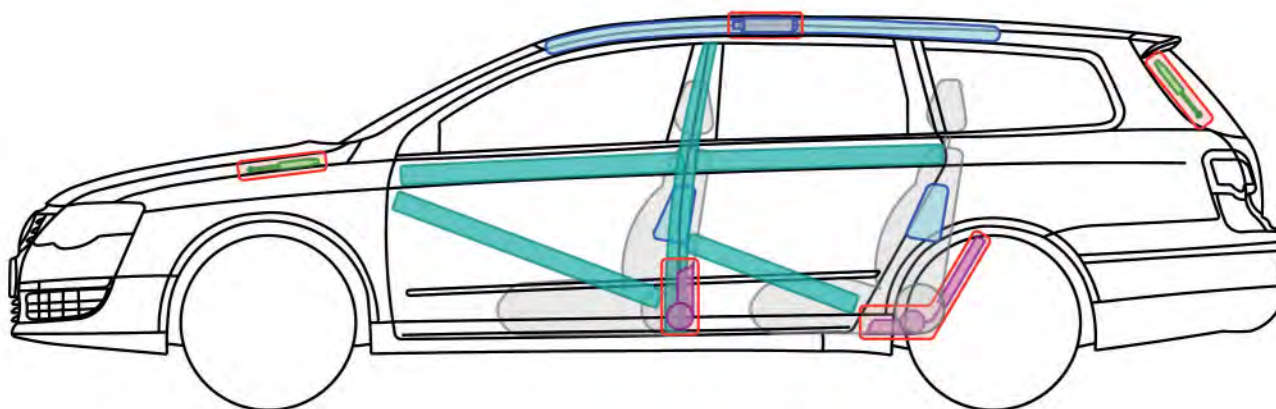

(Variant, ab 2005)



als 2. Batterie nur Passat R36 sonst ausstattungsabhängige Zusatzbatterie



Legende

	Airbag		Karosserie-Verstärkung		Steuergerät		
	Gas-generator				12V-Batterie		
	Gurtstraffer		Gasdruck-dämpfer		Kraftstoff-tank		Gurtstraffer



Passat B6

(Variant, ab 2005)



Fahrzeug deaktivieren

Batterie abklemmen (gilt nur bei Passat B6 R36)

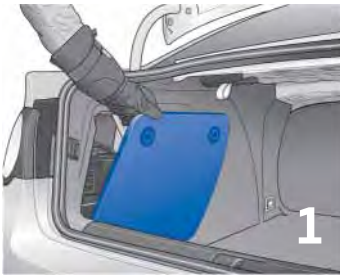

1. Batterieabdeckung im Kofferraum entfernen

- Batterieabdeckung im Kofferraum auf der linken Fahrzeugseite lokalisieren
- Befestigungsschrauben lösen und Abdeckung abnehmen

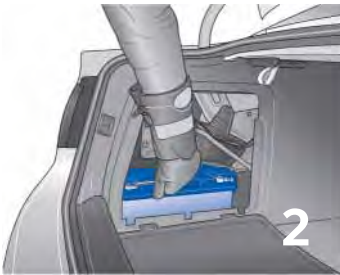

2. Masseanschluss (-) an der Batterie abklemmen



Passat B6

(Lim. EcoFuel, ab 2009)

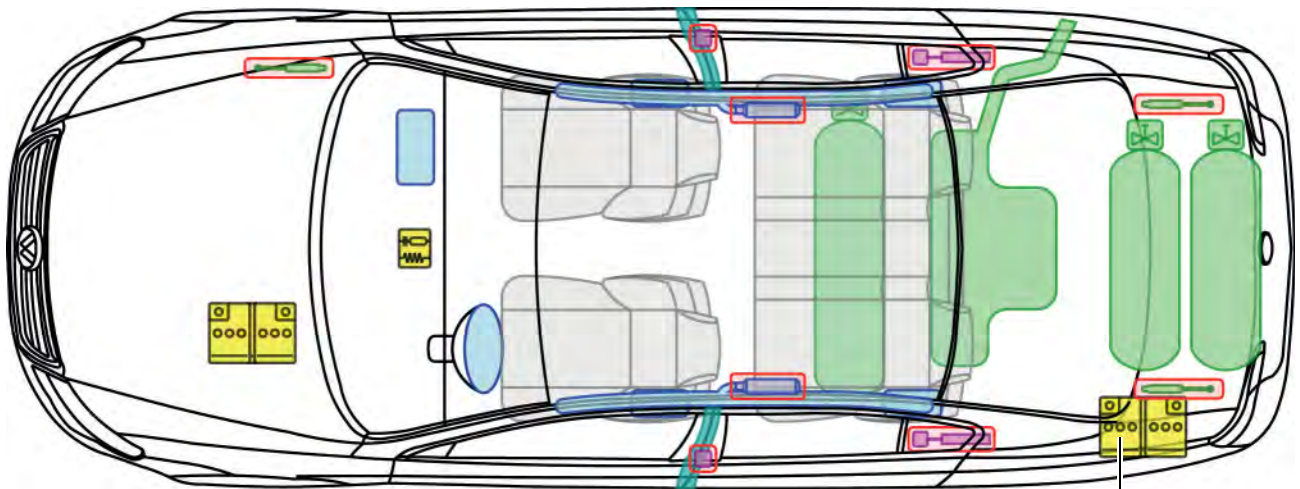







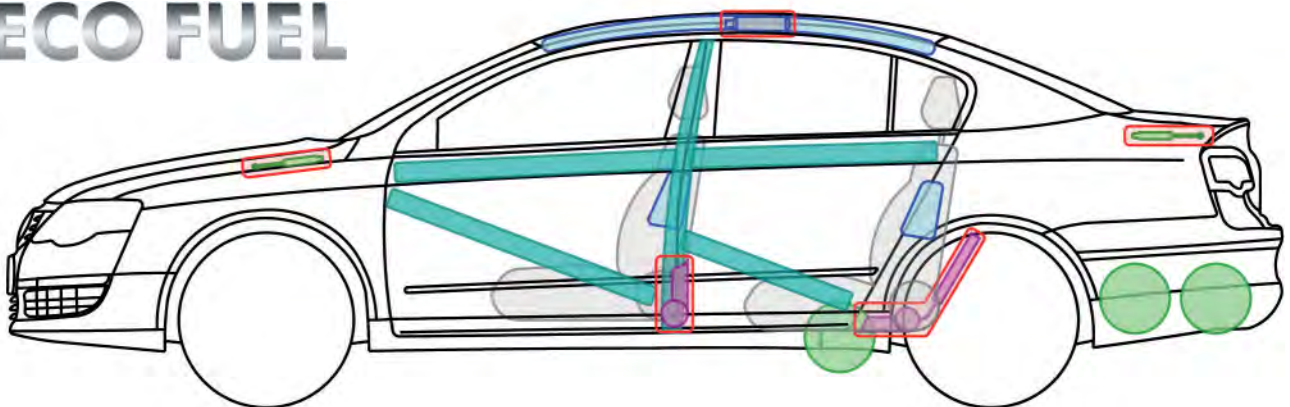



als 2. Batterie nur Passat R36 sonst ausstattungsabhängige Zusatzbatterie

Erdgasantrieb

ECO FUEL



Legende

	Airbag		Karosserie-Verstärkung		Steuergerät		Gastank
	Gas-generator				12V-Batterie		Sicherheits-ventil
	Gurtstraffer		Gasdruck-dämpfer		Kraftstoff-tank		Gurtstraffer



Passat B6

(Lim. EcoFuel, ab 2009)



Hinweise zur Erdgasanlage

Gastanks manuell absperren (bei Gasgeruch bzw. Austritt von Erdgas)

1. Zugang zu den Erdgastanks

- Der Zugang zu den Tanks erfolgt vom Unterboden aus.
- Die Gastanks sind durch eine Kunststoffabdeckung verkleidet. Um an die Erdgastanks zu gelangen, muss diese Abdeckung mit geeigneten Mitteln entfernt werden, ohne die darunter liegenden Bauteile der Gasanlage zu beschädigen.



elektromagnetische Absperrventile an den Gastanks

2. Absperrhähne lokalisieren

- Jeder Gastank besitzt ein eigenes Flaschenventil mit einem manuellen Absperrhahn.
- Falls einsatzbedingt erforderlich muss jeder Gastank separat abgesperrt werden.



manueller Absperrhahn am Fuß des Flaschenventils.

3. Gastank von Hand schließen

- Falls einsatzbedingt erforderlich muss jeder Gastank separat abgesperrt werden.
- Mit einem 5er-Maul- bzw. Ringschlüssel lässt sich das manuelle Absperrventil am Vierkant durch Drehen im Uhrzeigersinn bis zum Anschlag des Ventils verschließen.



Passat B6

(Variant EcoFuel, ab 2009)

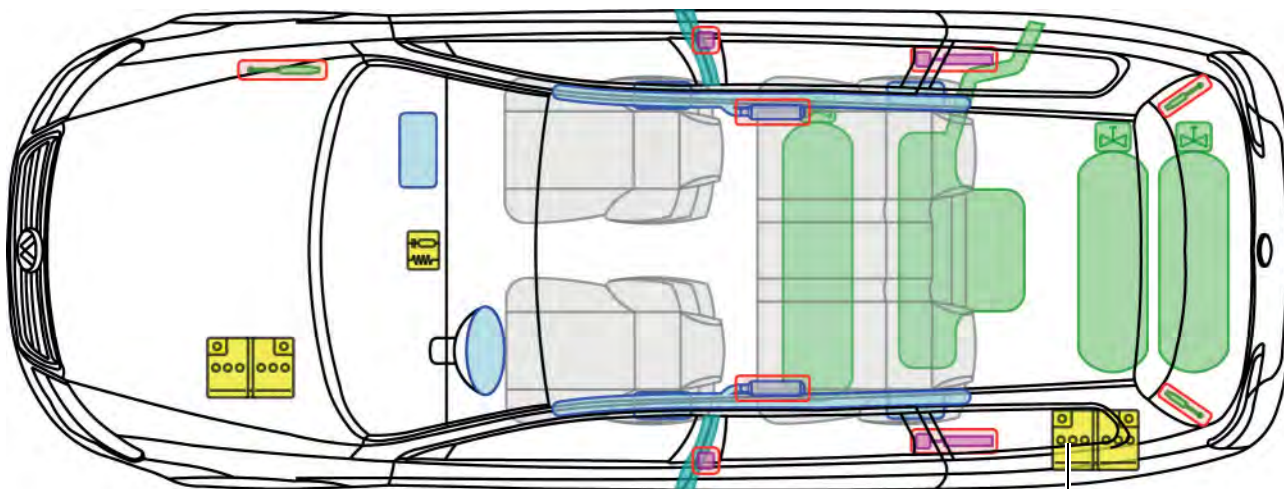







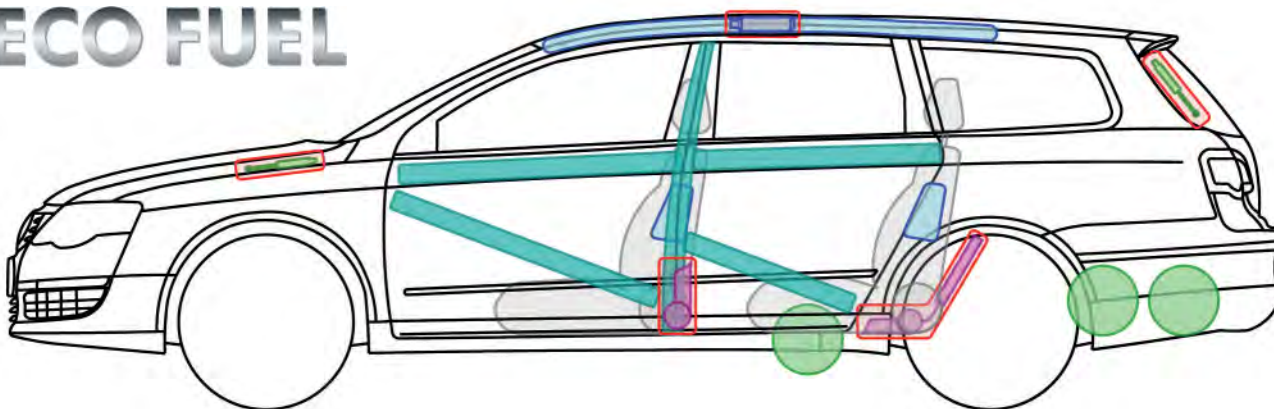



als 2. Batterie nur Passat R36 sonst ausstattungsabhängige Zusatzbatterie

Erdgasantrieb

ECO FUEL



Legende

	Airbag		Karosserie-Verstärkung		Steuergerät		Gastank
	Gas-generator				12V-Batterie		Sicherheits-ventil
	Gurtstraffer		Gasdruck-dämpfer		Kraftstoff-tank		Gurtstraffer



Passat B6

(Variant EcoFuel, ab 2009)



Hinweise zur Erdgasanlage

Gastanks manuell absperren (bei Gasgeruch bzw. Austritt von Erdgas)

1. Zugang zu den Erdgastanks

- Der Zugang zu den Tanks erfolgt vom Unterboden aus.
- Die Gastanks sind durch eine Kunststoffabdeckung verkleidet. Um an die Erdgastanks zu gelangen, muss diese Abdeckung mit geeigneten Mitteln entfernt werden, ohne die darunter liegenden Bauteile der Gasanlage zu beschädigen.



elektromagnetische Absperrventile an den Gastanks

2. Absperrhähne lokalisieren

- Jeder Gastank besitzt ein eigenes Flaschenventil mit einem manuellen Absperrhahn.
- Falls einsatzbedingt erforderlich muss jeder Gastank separat abgesperrt werden.



manueller Absperrhahn am Fuß des Flaschenventils.

3. Gastank von Hand schließen

- Falls einsatzbedingt erforderlich muss jeder Gastank separat abgesperrt werden.
- Mit einem 5er-Maul- bzw. Ringschlüssel lässt sich das manuelle Absperrventil am Vierkant durch Drehen im Uhrzeigersinn bis zum Anschlag des Ventils verschließen.

P

Passat B6 (Variant EcoFuel, ab 2009)



Passat B7



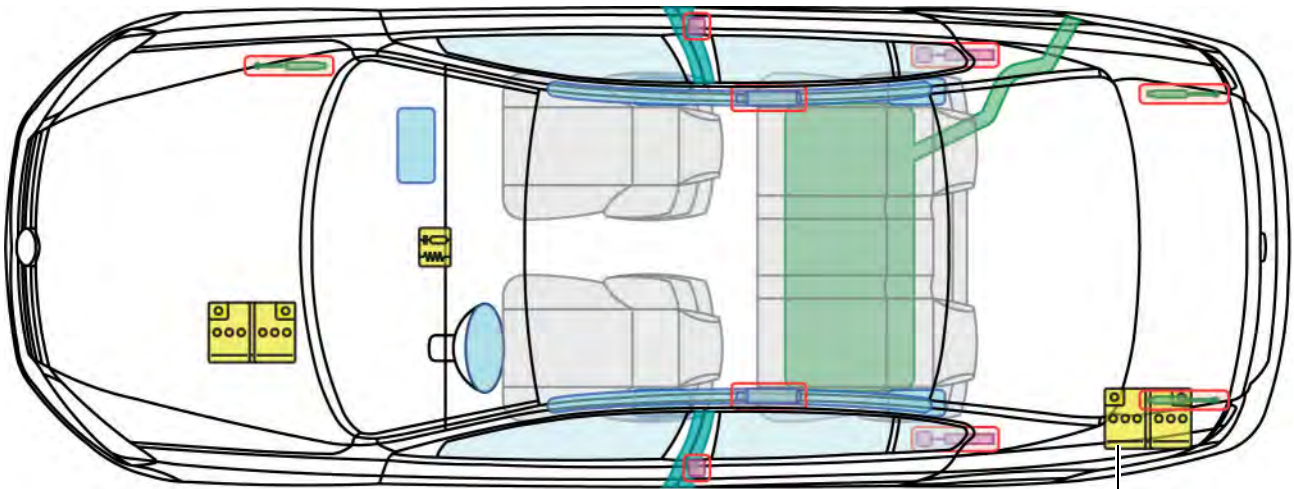



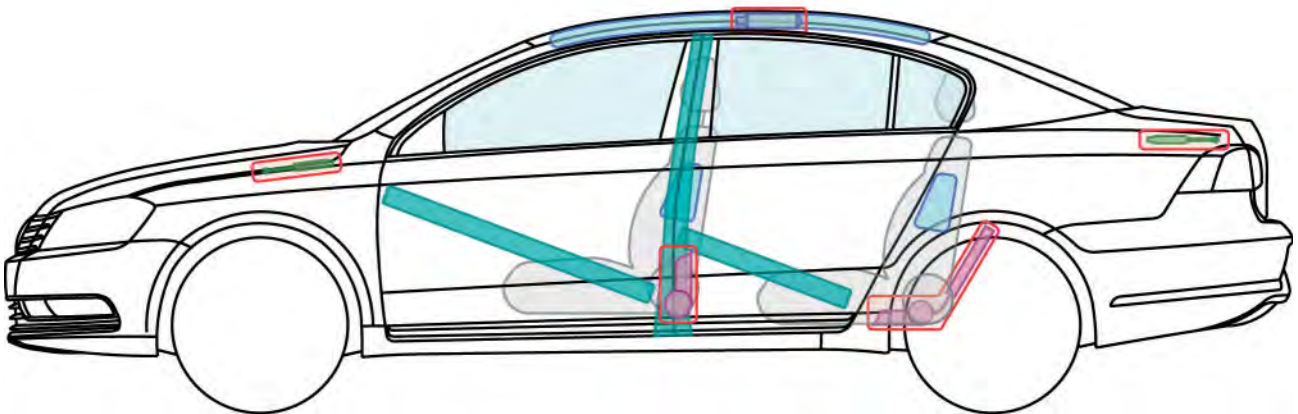

(Limousine, ab 2010)



als 2. Batterie nur Passat R36 sonst ausstattungsabhängige Zusatzbatterie



Legende

	Airbag		Karosserie-Verstärkung		Steuergerät		
	Gas-generator				12V-Batterie		
	Gurtstraffer		Gasdruck-dämpfer		Kraftstoff-tank		Gurtstraffer



Passat B7

(Limousine, ab 2010)



Fahrzeug deaktivieren

Batterie abklemmen (gilt nur bei Passat B7 R36)

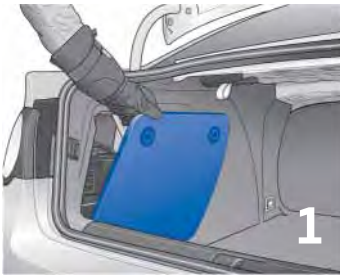

1. Batterieabdeckung im Kofferraum entfernen

- Batterieabdeckung im Kofferraum auf der linken Fahrzeugseite lokalisieren
- Befestigungsschrauben lösen und Abdeckung abnehmen

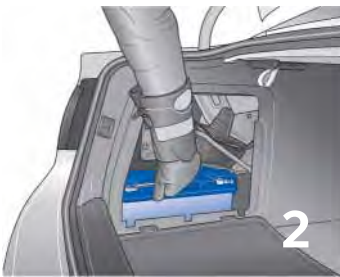

2. Masseanschluss (-) an der Batterie abklemmen



Passat B7



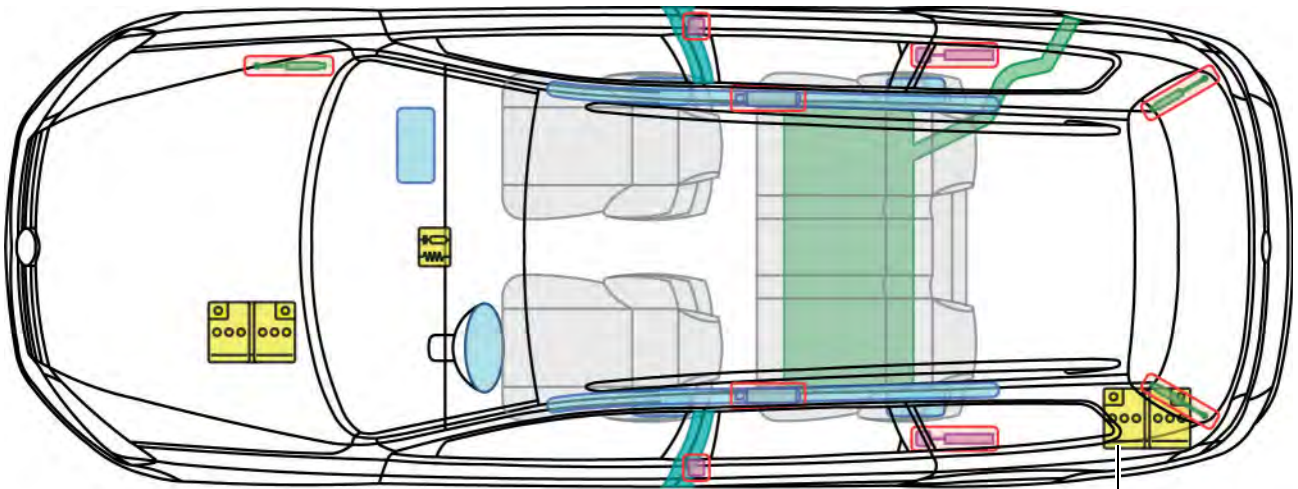



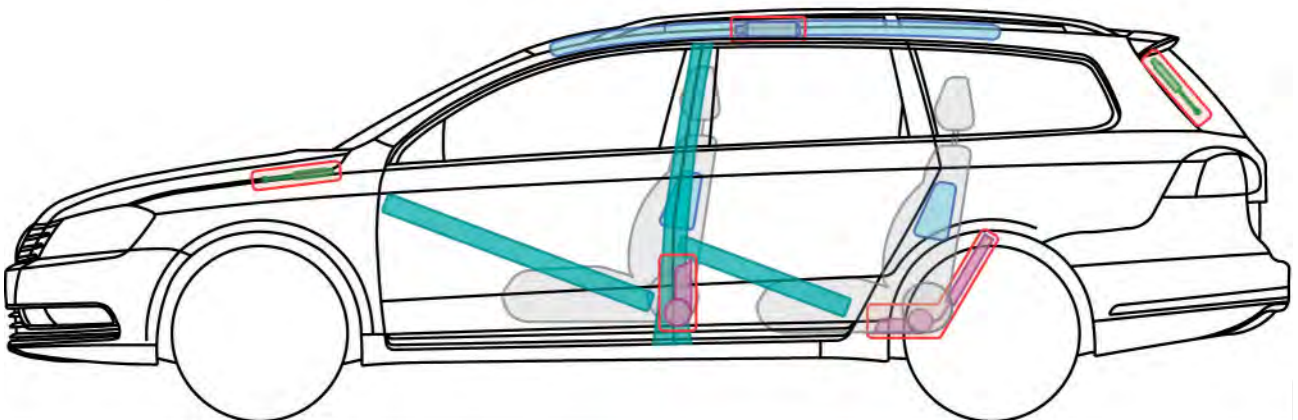

(Variant, ab 2010)



als 2. Batterie nur Passat R36 sonst ausstattungsabhängige Zusatzbatterie



Legende

	Airbag		Karosserie-Verstärkung		Steuergerät		
	Gas-generator				12V-Batterie		
	Gurtstraffer		Gasdruck-dämpfer		Kraftstoff-tank		Gurtstraffer



Passat B7 (Variant, ab 2010)



Fahrzeug deaktivieren

Batterie abklemmen (gilt nur bei Passat B7 R36)



1. Batterieabdeckung im Kofferraum entfernen

- Batterieabdeckung im Kofferraum auf der linken Fahrzeugseite lokalisieren
- Befestigungsschrauben lösen und Abdeckung abnehmen

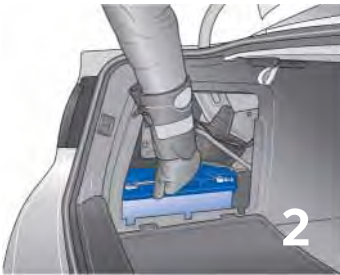

2. Masseanschluss (-) an der Batterie abklemmen



Passat B7

(Lim. EcoFuel, ab 2010)

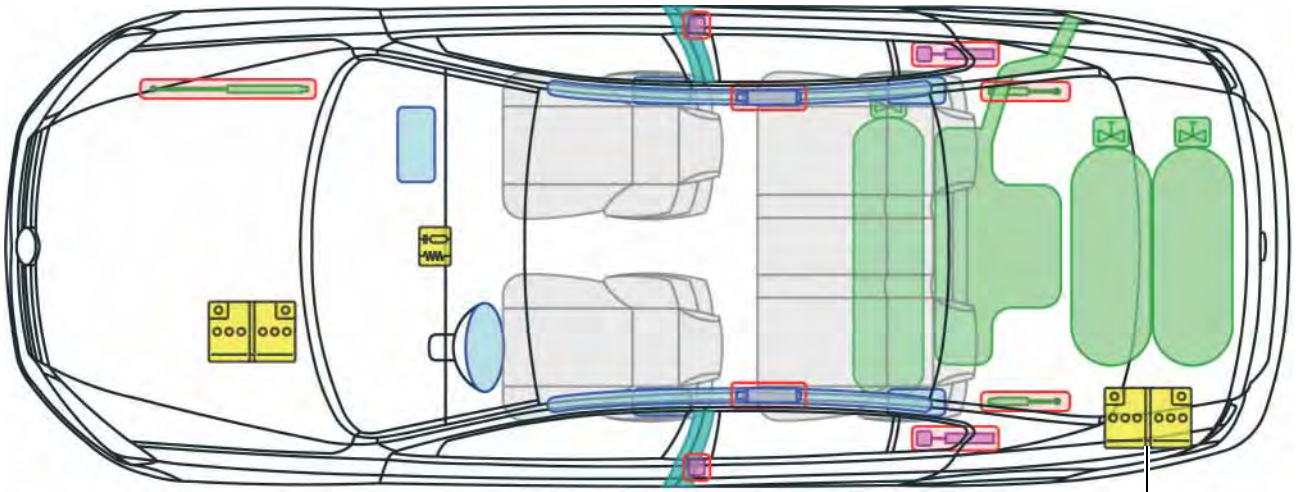







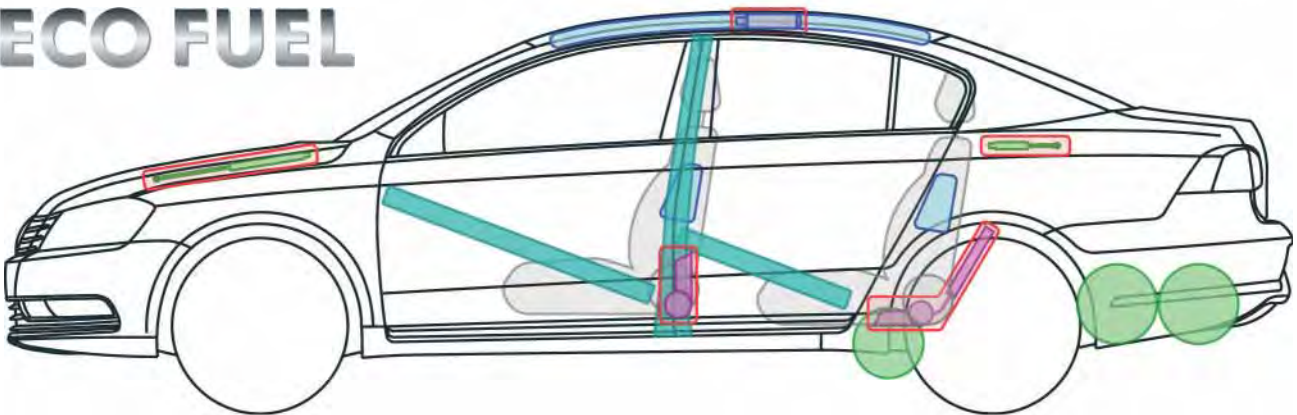



als 2. Batterie nur Passat R36 sonst ausstattungsabhängige Zusatzbatterie

Erdgasantrieb

ECO FUEL



Legende

	Airbag		Karosserie-Verstärkung		Steuergerät		Gastank
	Gas-generator				12V-Batterie		Sicherheits-ventil
	Gurtstraffer		Gasdruck-dämpfer		Kraftstoff-tank		Gurtstraffer



Hinweise zur Erdgasanlage

Gastanks manuell absperren (bei Gasgeruch bzw. Austritt von Erdgas)

1. Zugang zu den Erdgastanks

- Der Zugang zu den Tanks erfolgt vom Unterboden aus.
- Die Gastanks sind durch eine Kunststoffabdeckung verkleidet. Um an die Erdgastanks zu gelangen, muss diese Abdeckung mit geeigneten Mitteln entfernt werden, ohne die darunter liegenden Bauteile der Gasanlage zu beschädigen.



elektromagnetische Absperrventile an den Gastanks

2. Absperrhähne lokalisieren

- Jeder Gastank besitzt ein eigenes Flaschenventil mit einem manuellen Absperrhahn.
- Falls einsatzbedingt erforderlich muss jeder Gastank separat abgesperrt werden.



manueller Absperrhahn am Fuß des Flaschenventils.

3. Gastank von Hand schließen

- Falls einsatzbedingt erforderlich muss jeder Gastank separat abgesperrt werden.
- Mit einem 5er-Maul- bzw. Ringschlüssel lässt sich das manuelle Absperrventil am Vierkant durch Drehen im Uhrzeigersinn bis zum Anschlag des Ventils verschließen.



Passat B7

(Variant EcoFuel, ab 2010)

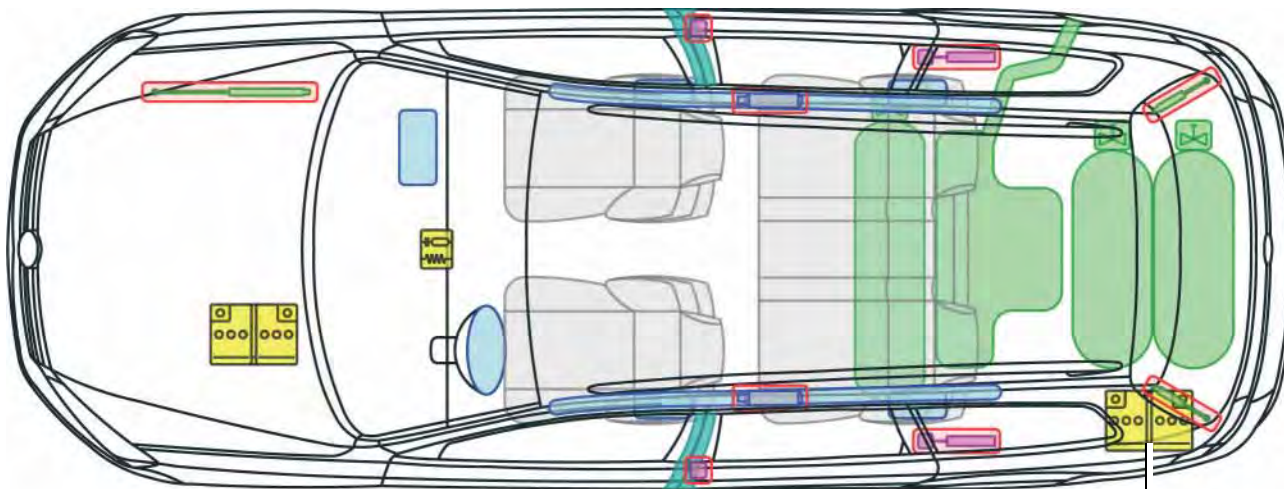







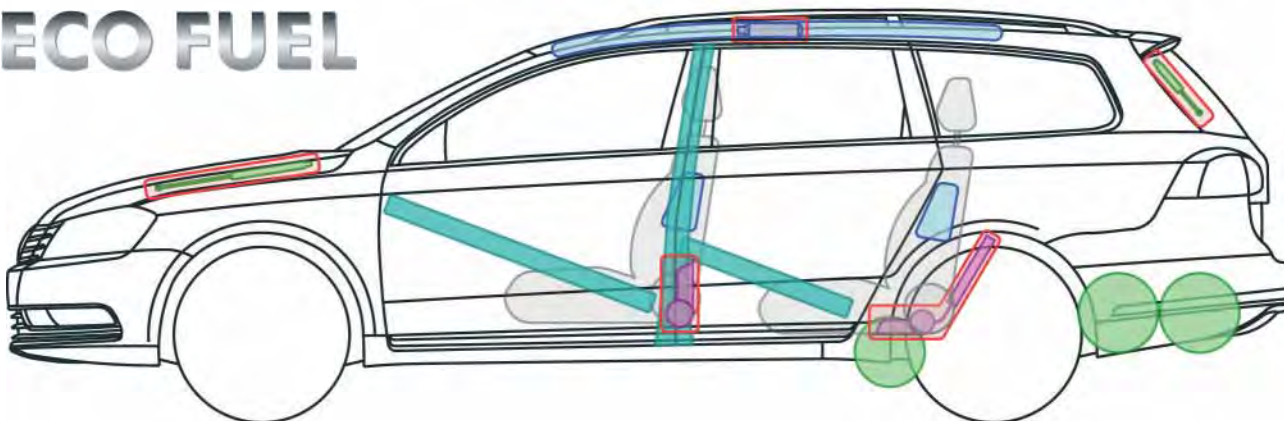



als 2. Batterie nur Passat R36 sonst ausstattungsabhängige Zusatzbatterie

Erdgasantrieb

ECO FUEL



Legende

	Airbag		Karosserie-Verstärkung		Steuergerät		Gastank
	Gas-generator				12V-Batterie		Sicherheitsventil
	Gurtstraffer		Gasdruck-dämpfer		Kraftstoff-tank		Gurtstraffer



Hinweise zur Erdgasanlage

Gastanks manuell absperren (bei Gasgeruch bzw. Austritt von Erdgas)

1. Zugang zu den Erdgastanks

- Der Zugang zu den Tanks erfolgt vom Unterboden aus.
- Die Gastanks sind durch eine Kunststoffabdeckung verkleidet. Um an die Erdgastanks zu gelangen, muss diese Abdeckung mit geeigneten Mitteln entfernt werden, ohne die darunter liegenden Bauteile der Gasanlage zu beschädigen.



elektromagnetische Absperrventile an den Gastanks

2. Absperrhähne lokalisieren

- Jeder Gastank besitzt ein eigenes Flaschenventil mit einem manuellen Absperrhahn.
- Falls einsatzbedingt erforderlich muss jeder Gastank separat abgesperrt werden.



manueller Absperrhahn am Fuß des Flaschenventils.

3. Gastank von Hand schließen

- Falls einsatzbedingt erforderlich muss jeder Gastank separat abgesperrt werden.
- Mit einem 5er-Maul- bzw. Ringschlüssel lässt sich das manuelle Absperrventil am Vierkant durch Drehen im Uhrzeigersinn bis zum Anschlag des Ventils verschließen.



Passat B8



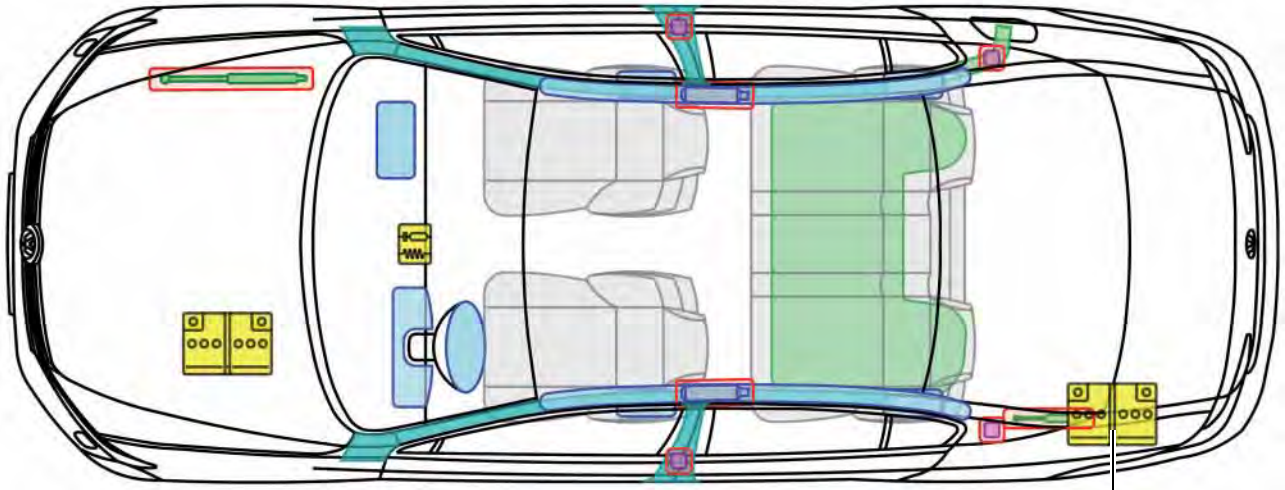



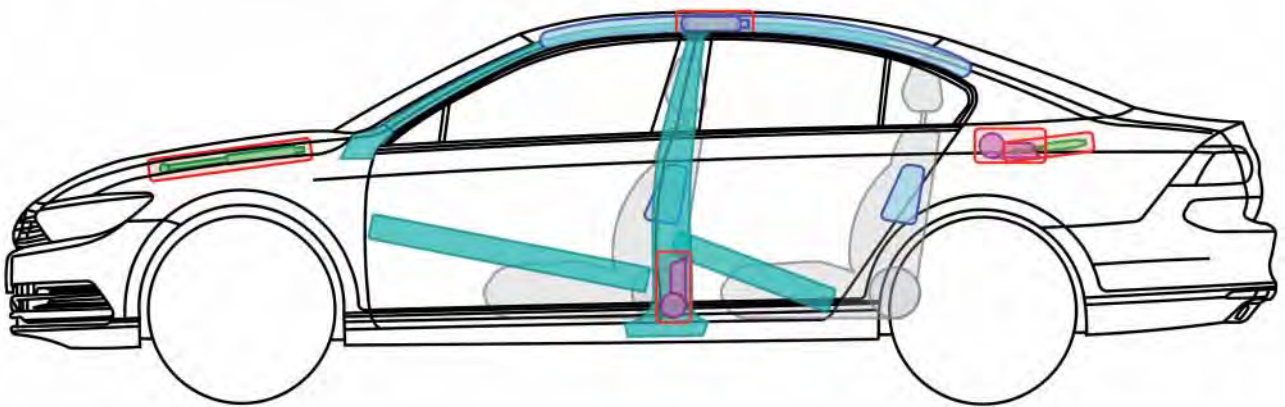

(Limousine, ab 2014)



als 2. Batterie ausstattungsabhängige Zusatzbatterie



Legende

	Airbag		Karosserie-Verstärkung		Steuergerät
	Gas-generator				12V-Batterie
	Gurtstraffer		Gasdruck-dämpfer		Kraftstoff-tank



Passat B8

(Limousine, ab 2014)



Fahrzeug deaktivieren

2. Batterie (ausstattungsabhängig) abklemmen



1. Batterieabdeckung im Kofferraum entfernen

- Batterieabdeckung im Kofferraum auf der linken Fahrzeugseite lokalisieren
- Befestigungsschrauben lösen und Abdeckung abnehmen

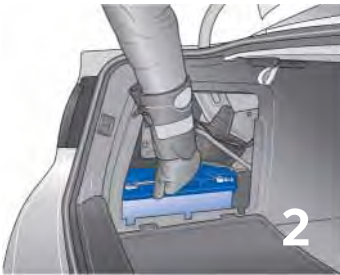

2. Masseanschluss (-) an der Batterie abklemmen







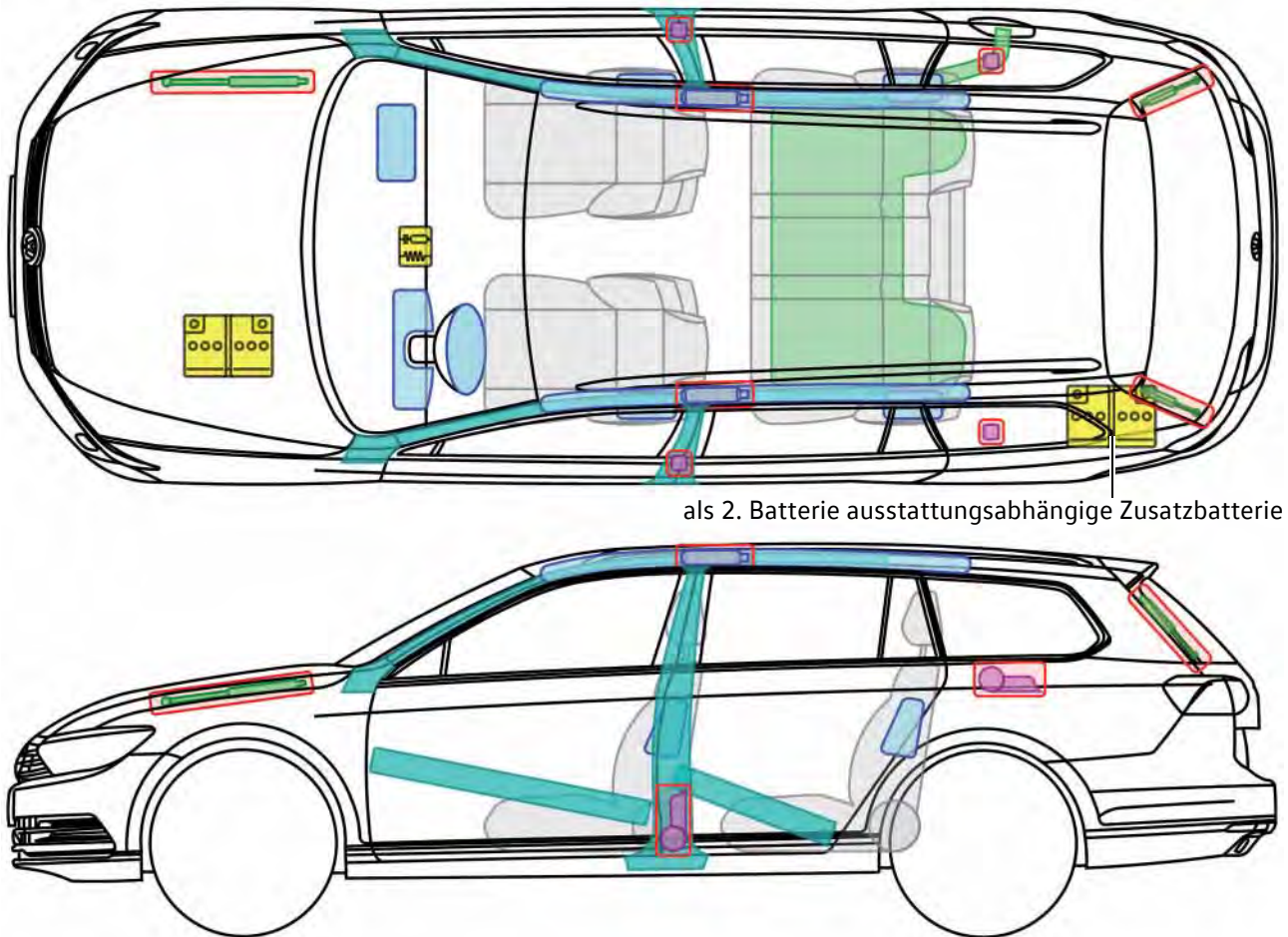



Passat B8

(Variant, ab 2014)



als 2. Batterie ausstattungsabhängige Zusatzbatterie

Legende

	Airbag		Karosserie-Verstärkung		Steuergerät
	Gas-generator				12V-Batterie
	Gurtstraffer		Gasdruck-dämpfer		Kraftstoff-tank



Passat B8

(Variant, ab 2014)



Fahrzeug deaktivieren

2. Batterie (ausstattungsabhängig) abklemmen



1. Batterieabdeckung im Kofferraum entfernen

- Batterieabdeckung im Kofferraum auf der linken Fahrzeugseite lokalisieren
- Befestigungsschrauben lösen und Abdeckung abnehmen

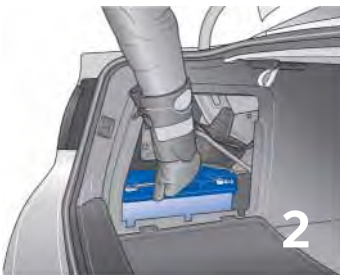

2. Masseanschluss (-) an der Batterie abklemmen







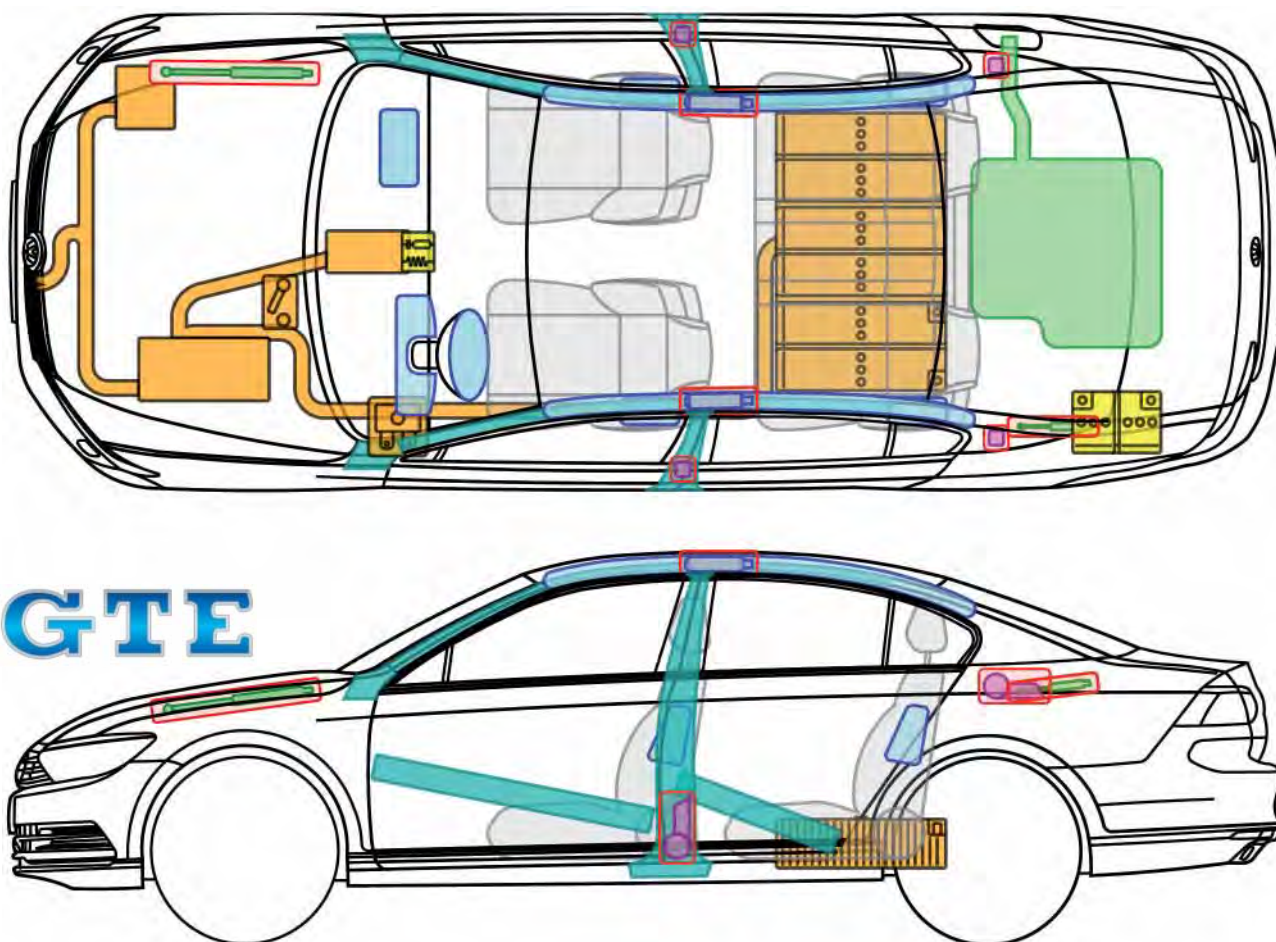







Passat B8 GTE

(Limousine, ab 2015)



GTE

Legende

 Airbag	 Karosserie-Verstärkung	 Steuergerät	 Hochvolt-batterie
 Gas-generator	 Sicherungsträger	 12V-Batterie	 Hochvolt-komponente/-leitung
 Gurtstraffer	 Gasdruck-dämpfer	 Kraftstoff-tank	 Trennstelle für Hochvolt



Passat B8 GTE

(Limousine, ab 2015)



Fahrzeugidentifizierung

Designleuchten
im Stoßfänger

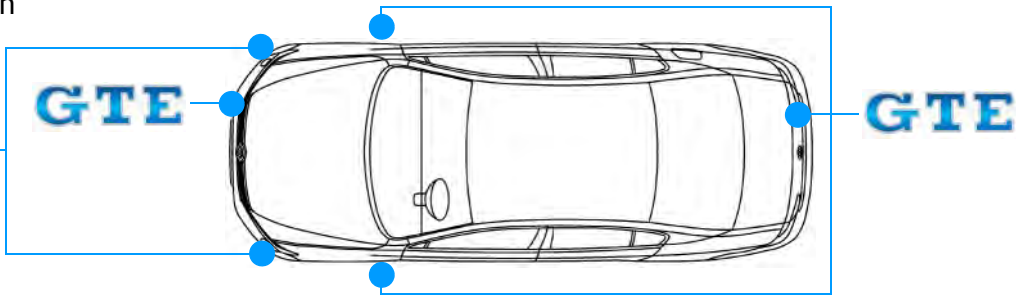

Fahrzeug gegen Wegrollen sichern

1. Gangwahlhebel in Stellung „P“ bringen.
2. Feststellbremse betätigen.

Antrieb und Hochvoltsystem deaktivieren

Zündung und Sicherungsträger im Innenraum zugänglich



1. Zündschlüssel in „AUS-Stellung“ drehen und abziehen oder Start-Stop-Taste drücken.



Die passiven Sicherheitssysteme wie Airbags und Gurtstraffer sind nach Ablauf der Entladungszeit des Airbagsteuergerätes von ca. 4 Sekunden durch das Drehen des Zündschlüssels in die Stellung „AUS“ deaktiviert. Vor Ablauf der Entladungszeit besteht eine Gefahr der Airbagauslösung aufgrund der Beschädigung des Airbagsystems.

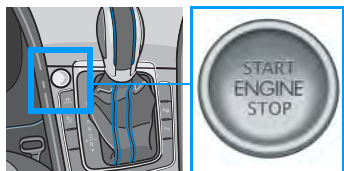

2. Ablagefach über dem Sicherungsträger der Schalttafel links entfernen. Gekennzeichnete Sicherung herausziehen. (gelbe Fahne)

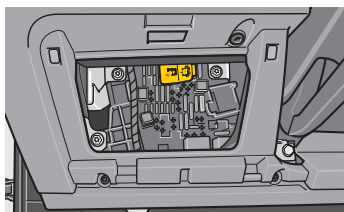

Das Hochvoltsystem ist nach dem Deaktivieren innerhalb von ca. 20 Sekunden spannungsfrei. Die passiven Sicherheitssysteme wie Airbags und Gurtstraffer sind dann deaktiviert.



P

Passat B8 GTE (Limousine, ab 2015)



Antrieb und Hochvoltsystem deaktivieren

Motorraum und Kofferraum zugänglich

UND 12V-Bordnetzbatterie abklemmen

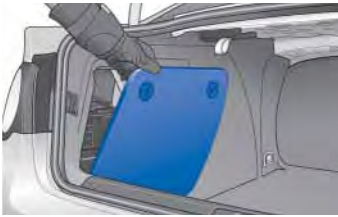

1. Batterieabdeckung im Kofferraum entfernen

- Batterieabdeckung im Kofferraum auf der linken Fahrzeugseite lokalisieren
- Befestigungsschrauben lösen und Abdeckung abnehmen



2. 12V-Bordnetzbatterie am Minuspol mit geeignetem Werkzeug abklemmen.



Das Hochvoltsystem ist nach dem Deaktivieren innerhalb von ca. 20 Sekunden spannungsfrei. Die passiven Sicherheitssysteme wie Airbags und Gurtstraffer sind dann deaktiviert.

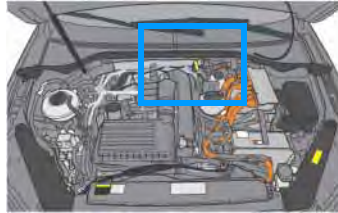

3. Rettungstrennstelle im Motorraum lokalisieren.

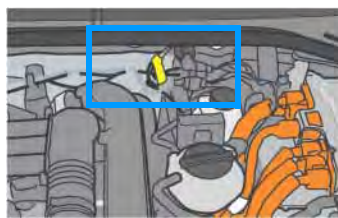

4. Rettungstrennstelle öffnen.

Vorgehensweise ist auf dem Label beschrieben!



Das Hochvoltsystem ist nach dem Deaktivieren innerhalb von ca. 20 Sekunden spannungsfrei. Die passiven Sicherheitssysteme wie Airbags und Gurtstraffer sind dann deaktiviert.



An der Ladesäule angeschlossenes Fahrzeug

Fahrzeug entriegeln. Das Ladekabel vom Fahrzeug trennen und ggf. bei schweren Unfällen das Hochvoltsystem des Fahrzeugs deaktivieren (siehe unter „Fahrzeug deaktivieren“)!



Passat B8 GTE



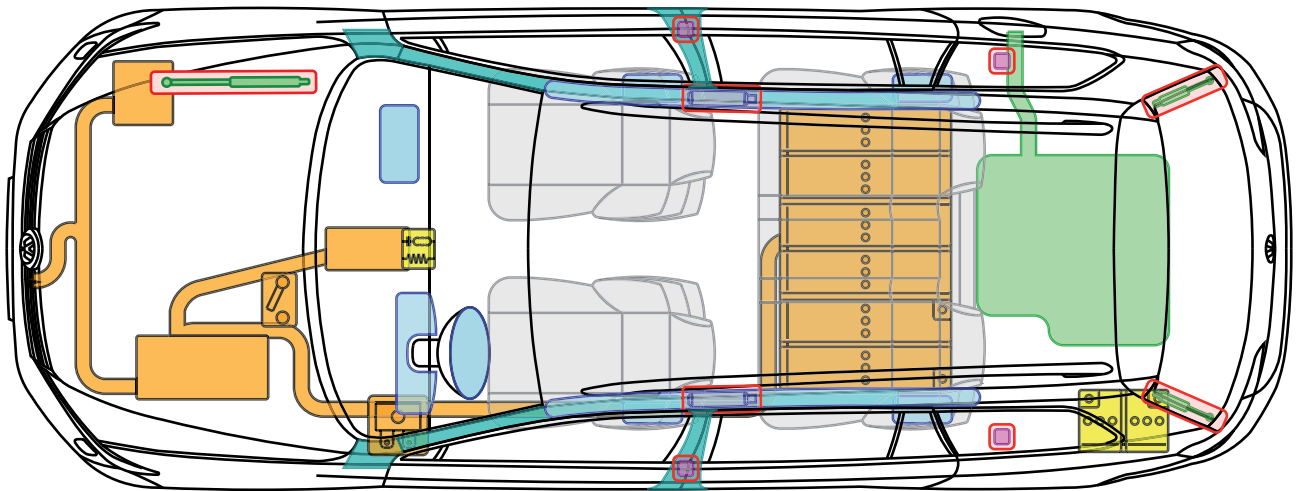



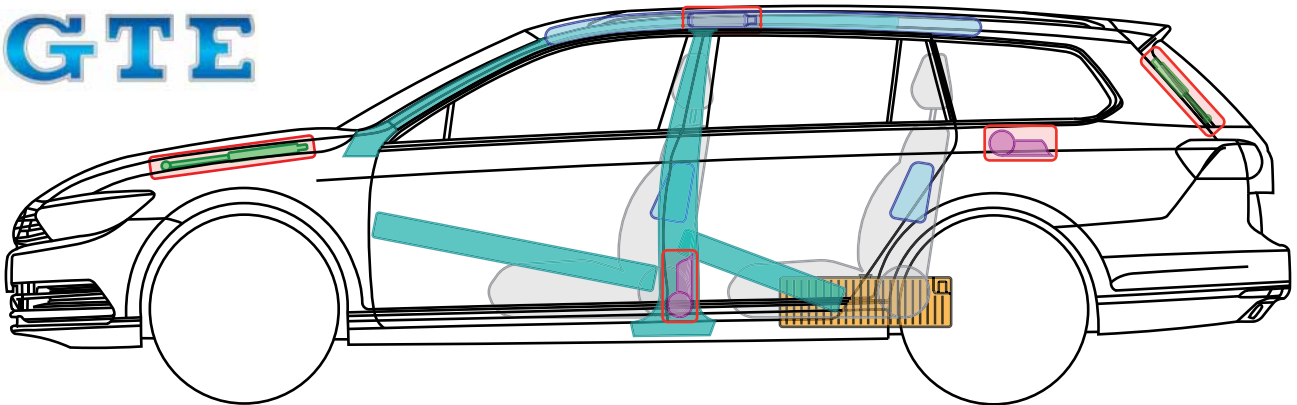





(Variant, ab 2015)



GTE



Legende

 Airbag	 Karosserie-Verstärkung	 Steuergerät	 Hochvolt-batterie
 Gas-generator	 Sicherungs-träger	 12V-Batterie	 Hochvolt-komponente/-leitung
 Gurtstraffer	 Gasdruck-dämpfer	 Kraftstoff-tank	 Trennstelle für Hochvolt



Passat B8 GTE (Variant, ab 2015)



Fahrzeugidentifizierung

Designleuchten
im Stoßfänger



GTE

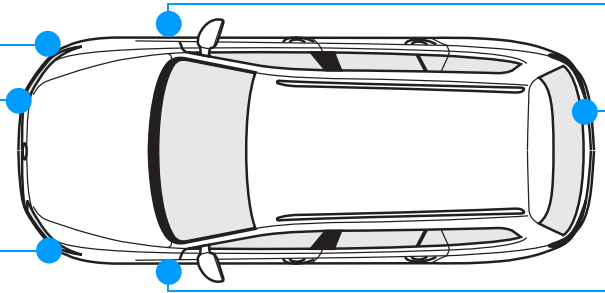

GTE

Fahrzeug gegen Wegrollen sichern

1. Gangwahlhebel in Stellung „P“ bringen.
2. Feststellbremse betätigen.

Antrieb und Hochvoltsystem deaktivieren

Zündung und Sicherungsträger im Innenraum zugänglich



1. Zündschlüssel in „AUS-Stellung“ drehen und abziehen oder Start-Stop-Taste drücken.



Die passiven Sicherheitssysteme wie Airbags und Gurtstraffer sind nach Ablauf der Entladungszeit des Airbagsteuergerätes von ca. 4 Sekunden durch das Drehen des Zündschlüssels in die Stellung „AUS“ deaktiviert. Vor Ablauf der Entladungszeit besteht eine Gefahr der Airbagauslösung aufgrund der Beschädigung des Airbagsystems.

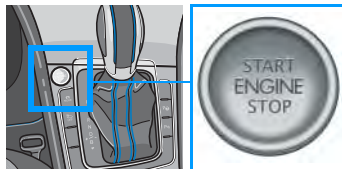

2. Ablagefach über dem Sicherungsträger der Schalttafel links entfernen. Gekennzeichnete Sicherung herausziehen. (gelbe Fahne)

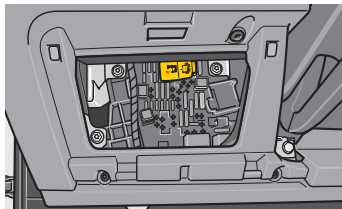

Das Hochvoltsystem ist nach dem Deaktivieren innerhalb von ca. 20 Sekunden spannungsfrei. Die passiven Sicherheitssysteme wie Airbags und Gurtstraffer sind dann deaktiviert.



P

Passat B8 GTE (Variant, ab 2015)



Antrieb und Hochvoltsystem deaktivieren

Motorraum und Kofferraum zugänglich

UND 12V-Bordnetzbatterie abklemmen

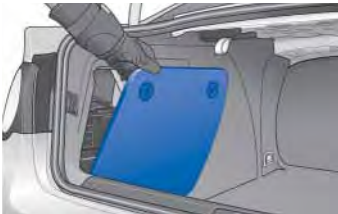

1. Batterieabdeckung im Kofferraum entfernen

- Batterieabdeckung im Kofferraum auf der linken Fahrzeugseite lokalisieren
- Befestigungsschrauben lösen und Abdeckung abnehmen



2. 12V-Bordnetzbatterie am Minuspol mit geeignetem Werkzeug abklemmen.



Das Hochvoltsystem ist nach dem Deaktivieren innerhalb von ca. 20 Sekunden spannungsfrei. Die passiven Sicherheitssysteme wie Airbags und Gurtstraffer sind dann deaktiviert.

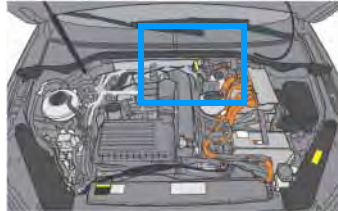

3. Rettungstrennstelle im Motorraum lokalisieren.



4. Rettungstrennstelle öffnen.

Vorgehensweise ist auf dem Label beschrieben!



Das Hochvoltsystem ist nach dem Deaktivieren innerhalb von ca. 20 Sekunden spannungsfrei. Die passiven Sicherheitssysteme wie Airbags und Gurtstraffer sind dann deaktiviert.



An der Ladesäule angeschlossenes Fahrzeug

Fahrzeug entriegeln. Das Ladekabel vom Fahrzeug trennen und ggf. bei schweren Unfällen das Hochvoltsystem des Fahrzeugs deaktivieren (siehe unter „Fahrzeug deaktivieren“)!



Passat CC



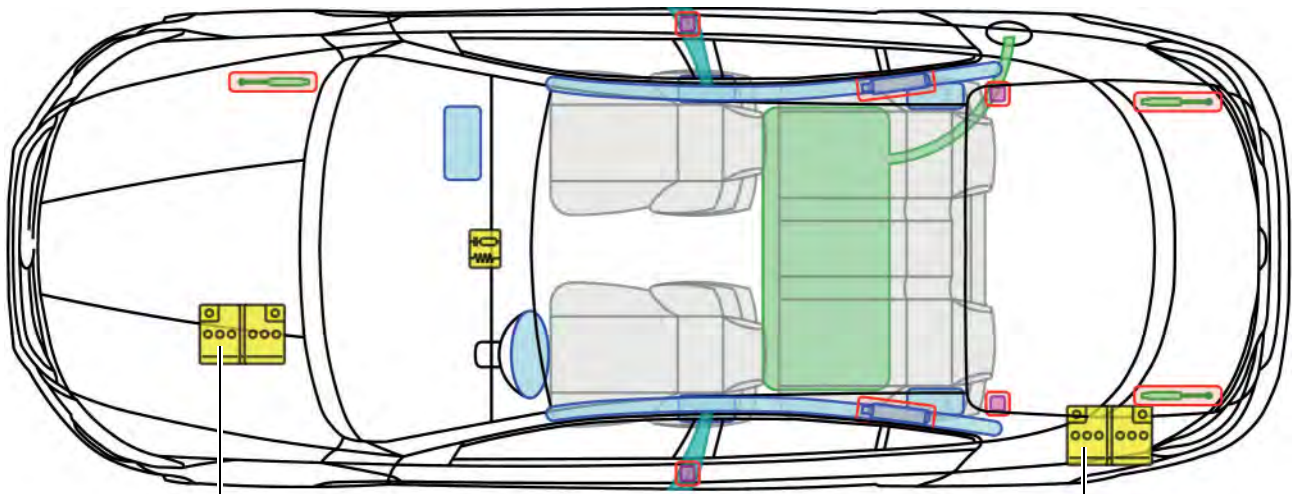



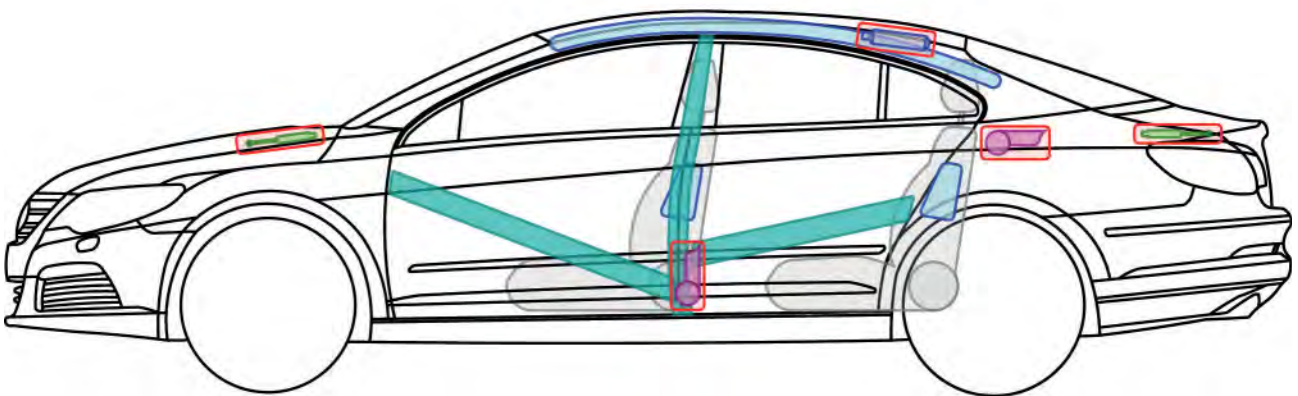

(ab 2008)



Einbauort ausstattungsabhängig - keine 2. Batterie



Legende

	Airbag		Karosserie-Verstärkung		Steuergerät
	Gas-generator				12V-Batterie
	Gurtstraffer		Gasdruck-dämpfer		Kraftstoff-tank



Fahrzeug deaktivieren

Batterie abklemmen (bei Einbauort Kofferraum)

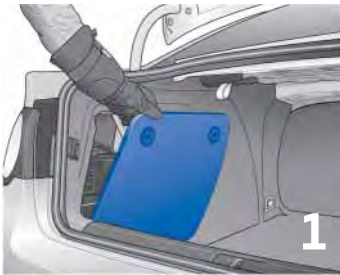

1. Batterieabdeckung im Kofferraum entfernen

- Batterieabdeckung im Kofferraum auf der linken Fahrzeugseite lokalisieren
- Befestigungsschrauben lösen und Abdeckung abnehmen

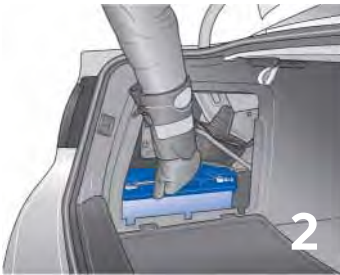

2. Masseanschluss (-) an der Batterie abklemmen



Phaeton



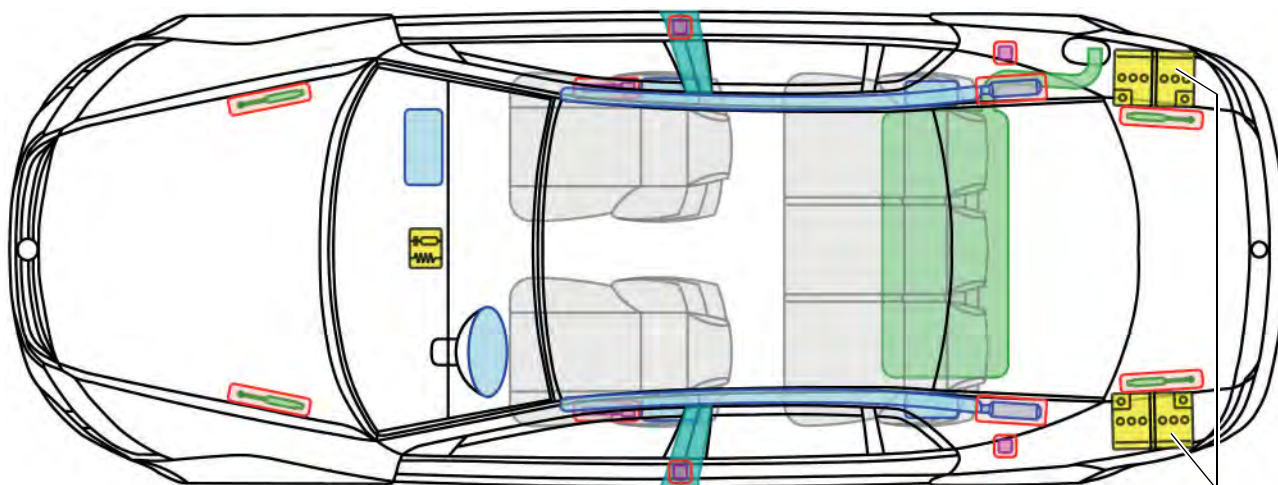



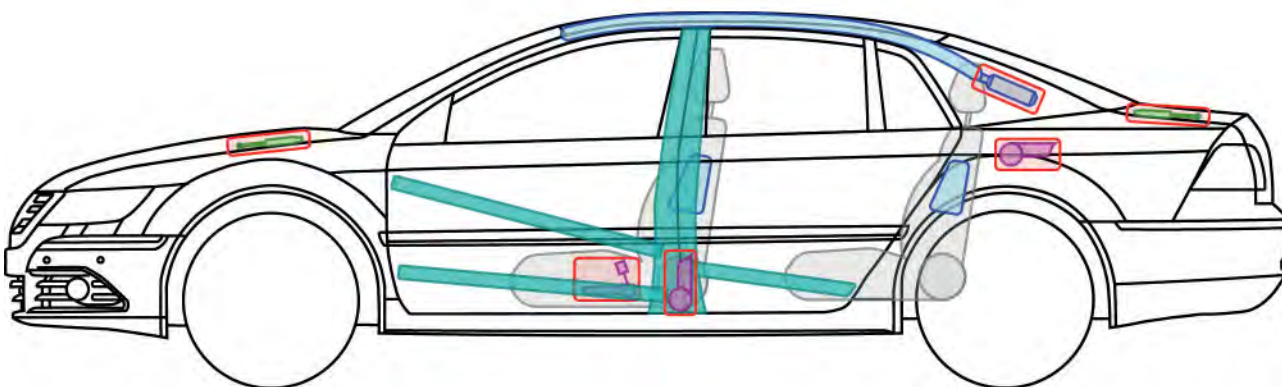

(ab 2002)



in jeder Ausstattung 2 Batterien im Kofferraum links und rechts.



Legende

	Airbag		Karosserie-Verstärkung		Steuergerät
	Gas-generator				12V-Batterie
	Gurtstraffer		Gasdruck-dämpfer		Kraftstoff-tank
					Beckengurt-straffer



Phaeton

(ab 2002)



Fahrzeug deaktivieren

Batterien abklemmen



1. Batterieabdeckungen im Kofferraum entfernen

- Batterieabdeckung im Kofferraum auf der linken und der rechten Fahrzeugseite lokalisieren
- Befestigungsschrauben lösen und beide Abdeckungen abnehmen

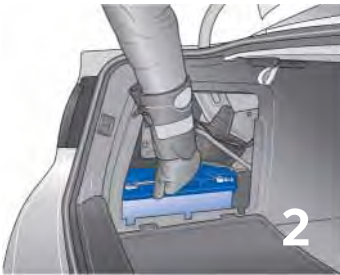

2. Masseanschluss (-) an beiden Batterien abklemmen







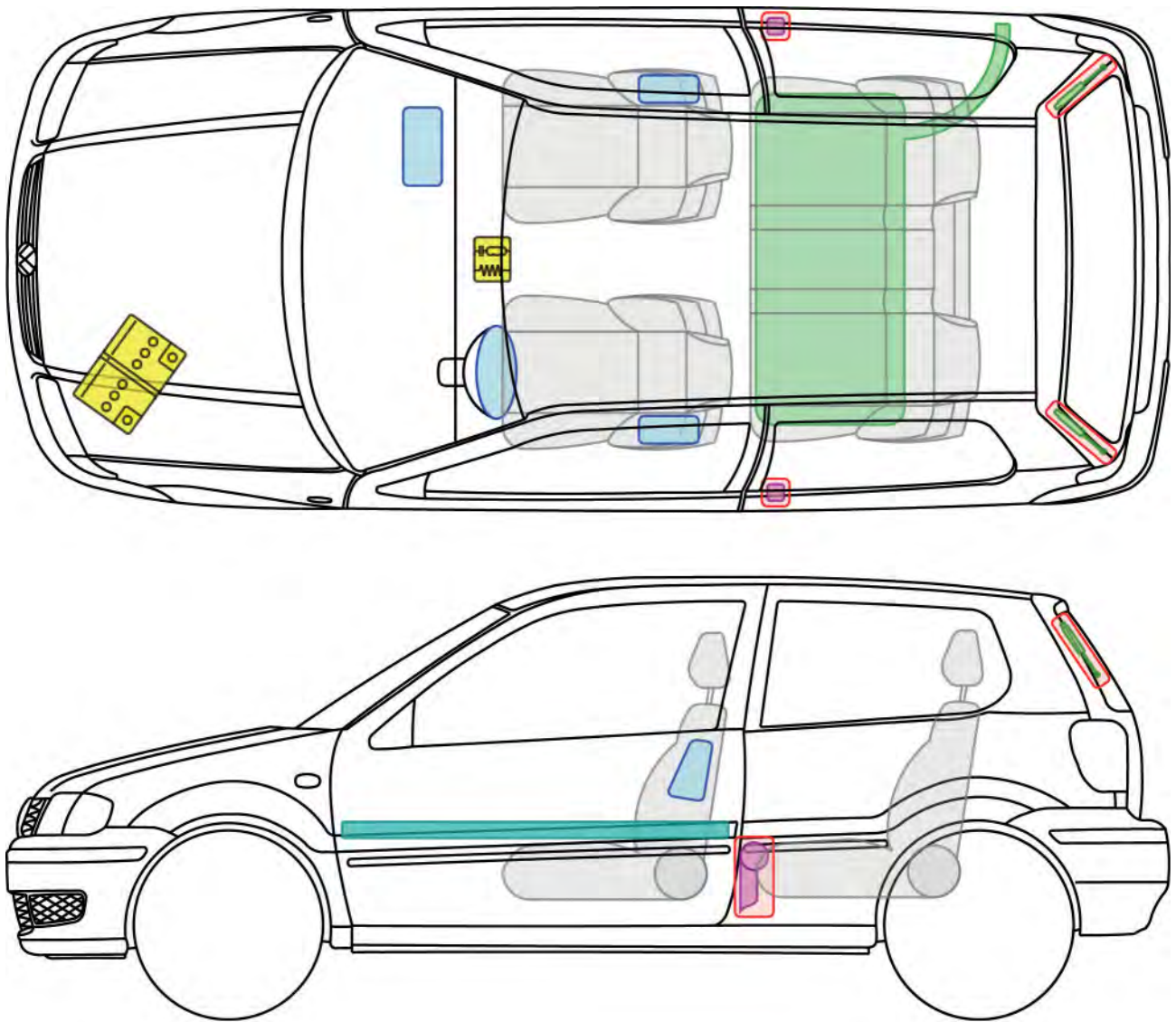

Polo A03

(3-Türer, ab 1994)



Legende

	Airbag		Karosserie-Verstärkung		Steuergerät
					12V-Batterie
	Gurtstraffer		Gasdruck-dämpfer		Kraftstoff-tank







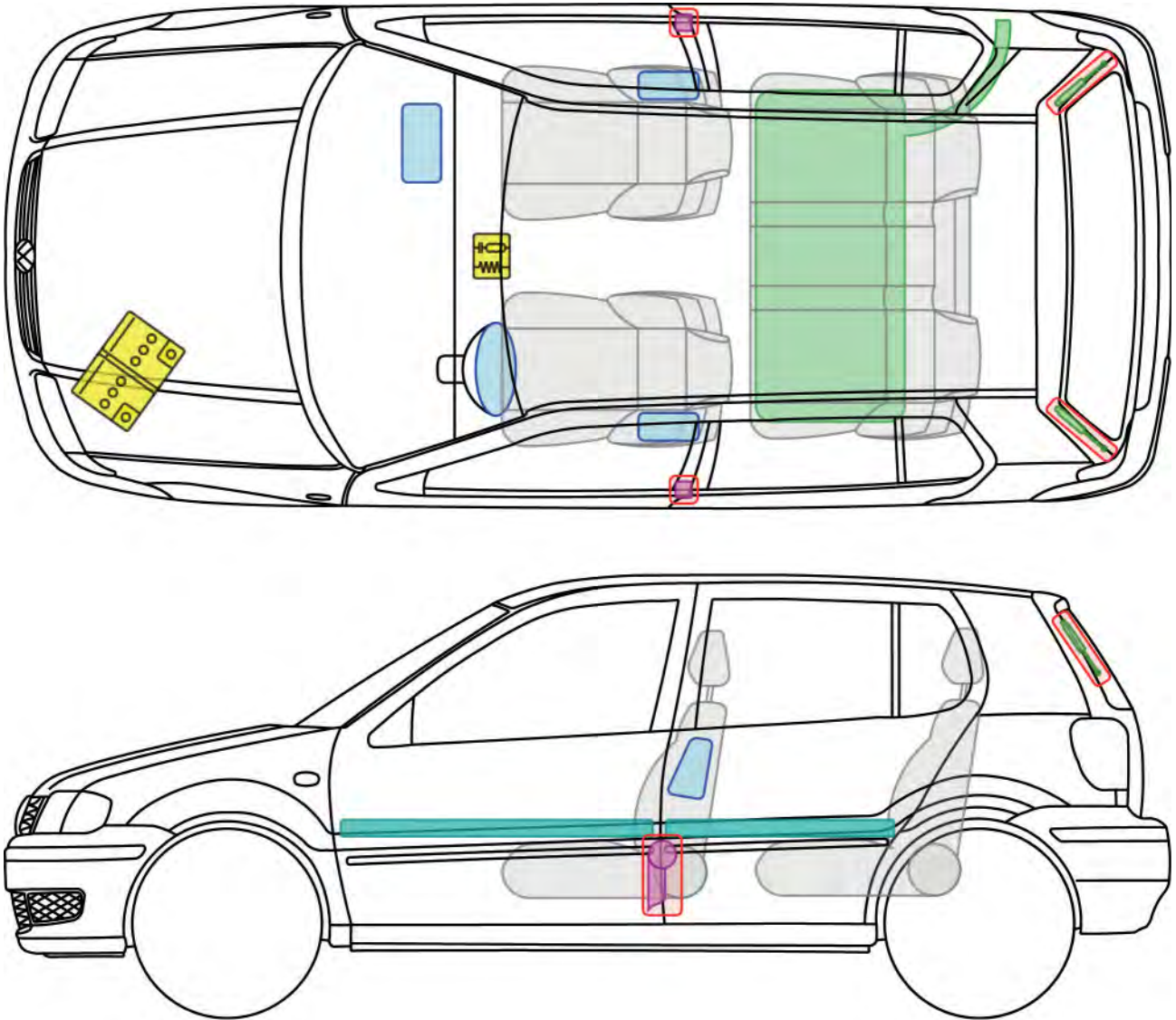

Polo A03

(5-Türer, ab 1994)



Legende

	Airbag		Karosserie-Verstärkung		Steuergerät
					12V-Batterie
	Gurtstraffer		Gasdruck-dämpfer		Kraftstoff-tank







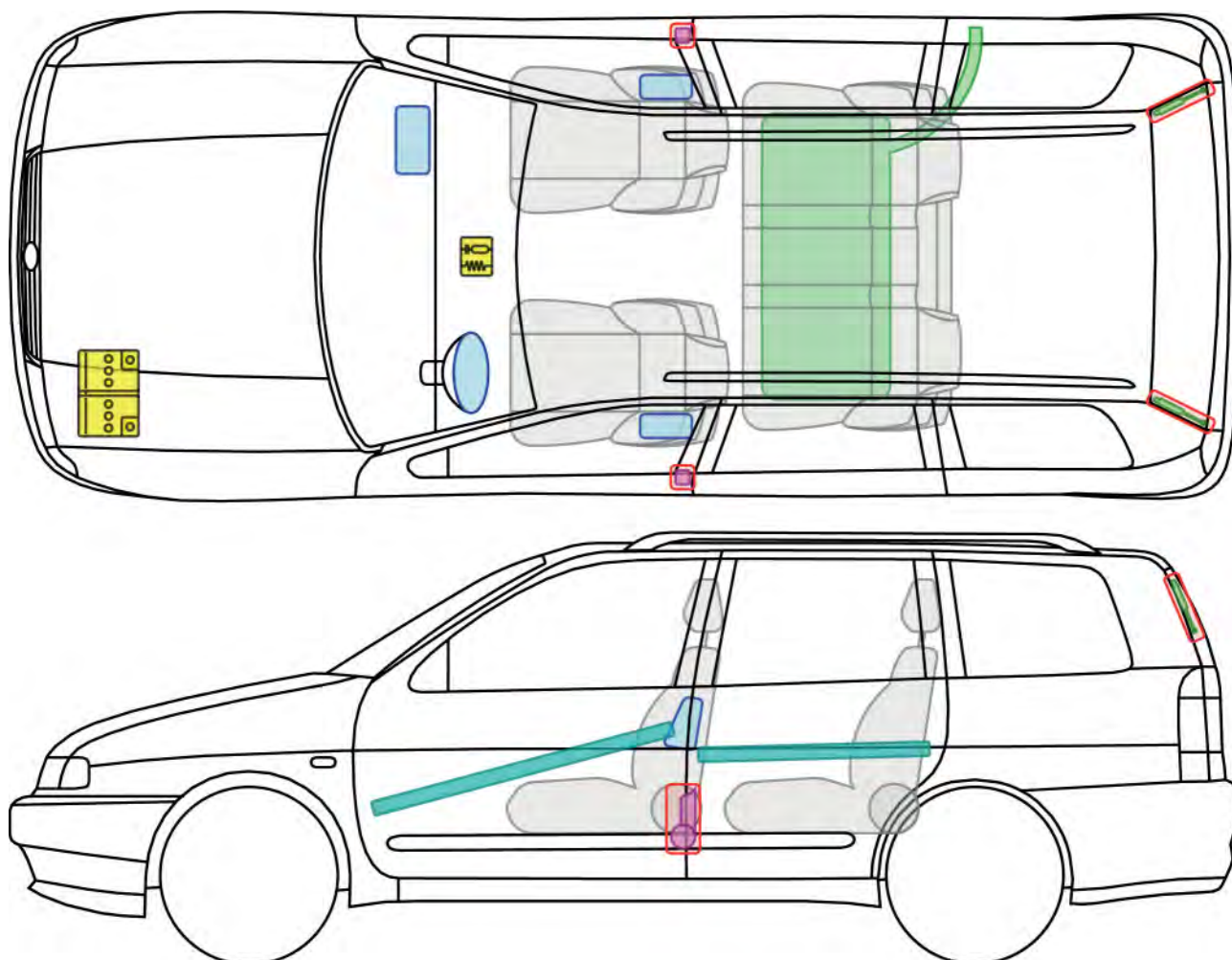

Polo A03

(Variant, ab 1994)



Legende

	Airbag		Karosserie-Verstärkung		Steuergerät	
					12V-Batterie	
	Gurtstraffer		Gasdruck-dämpfer		Kraftstoff-tank	







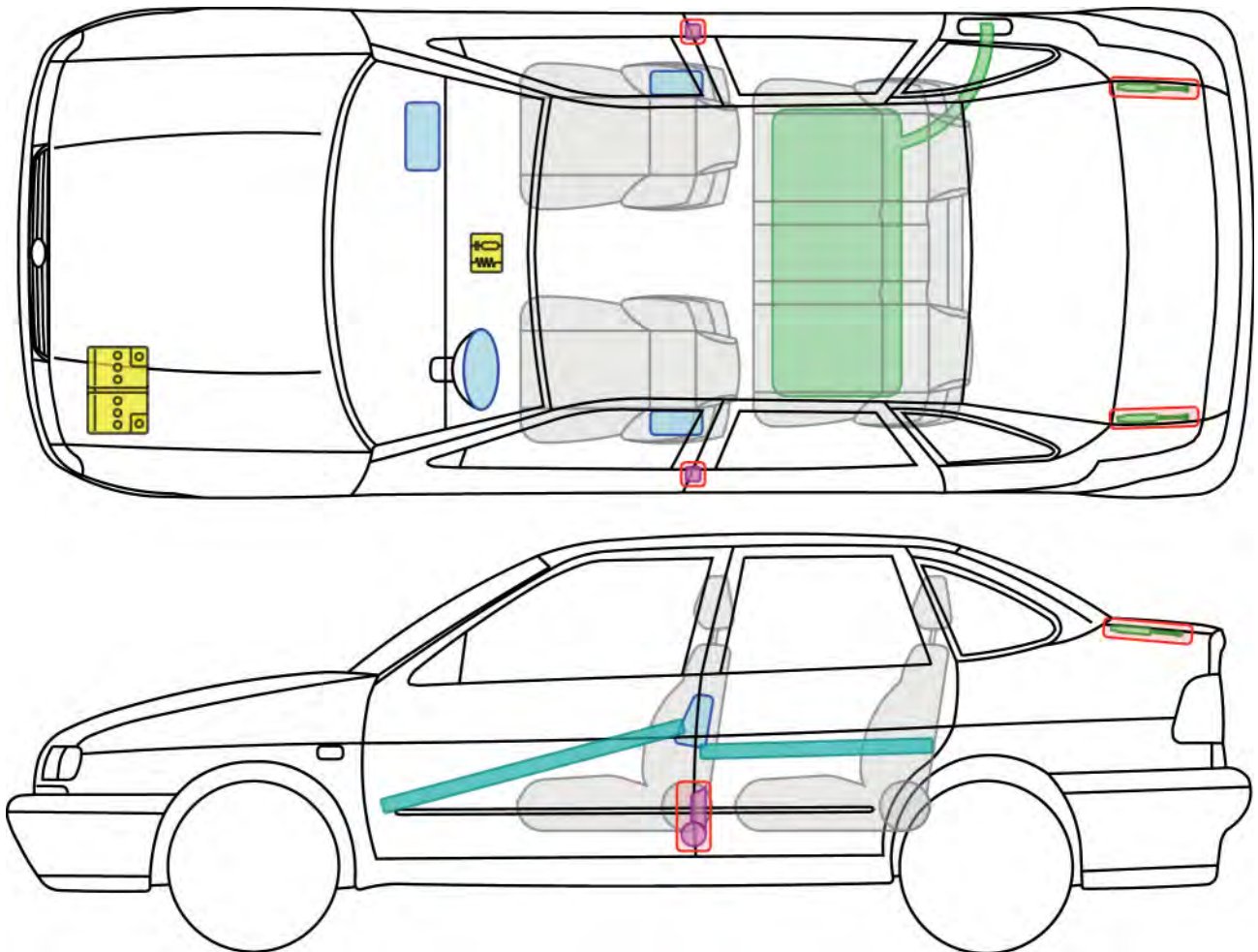

Polo A03

(Stufenheck, ab 1994)



Legende

	Airbag		Karosserie-Verstärkung		Steuergerät
					12V-Batterie
	Gurtstraffer		Gasdruck-dämpfer		Kraftstoff-tank







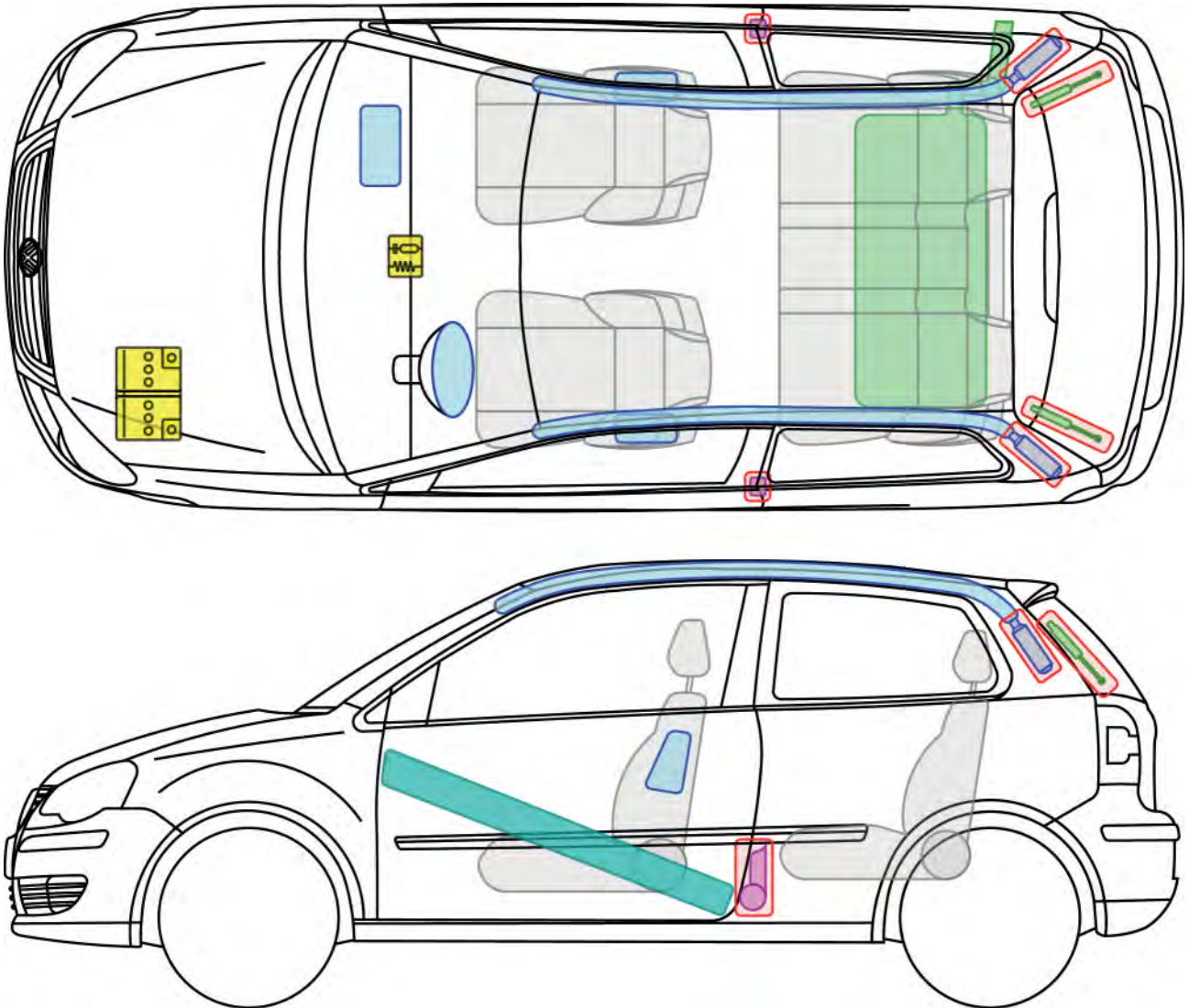



Polo A04

(3-Türer, ab 2001)



Legende

	Airbag		Karosserie-Verstärkung		Steuergerät
	Gas-generator				12V-Batterie
	Gurtstraffer		Gasdruck-dämpfer		Kraftstoff-tank







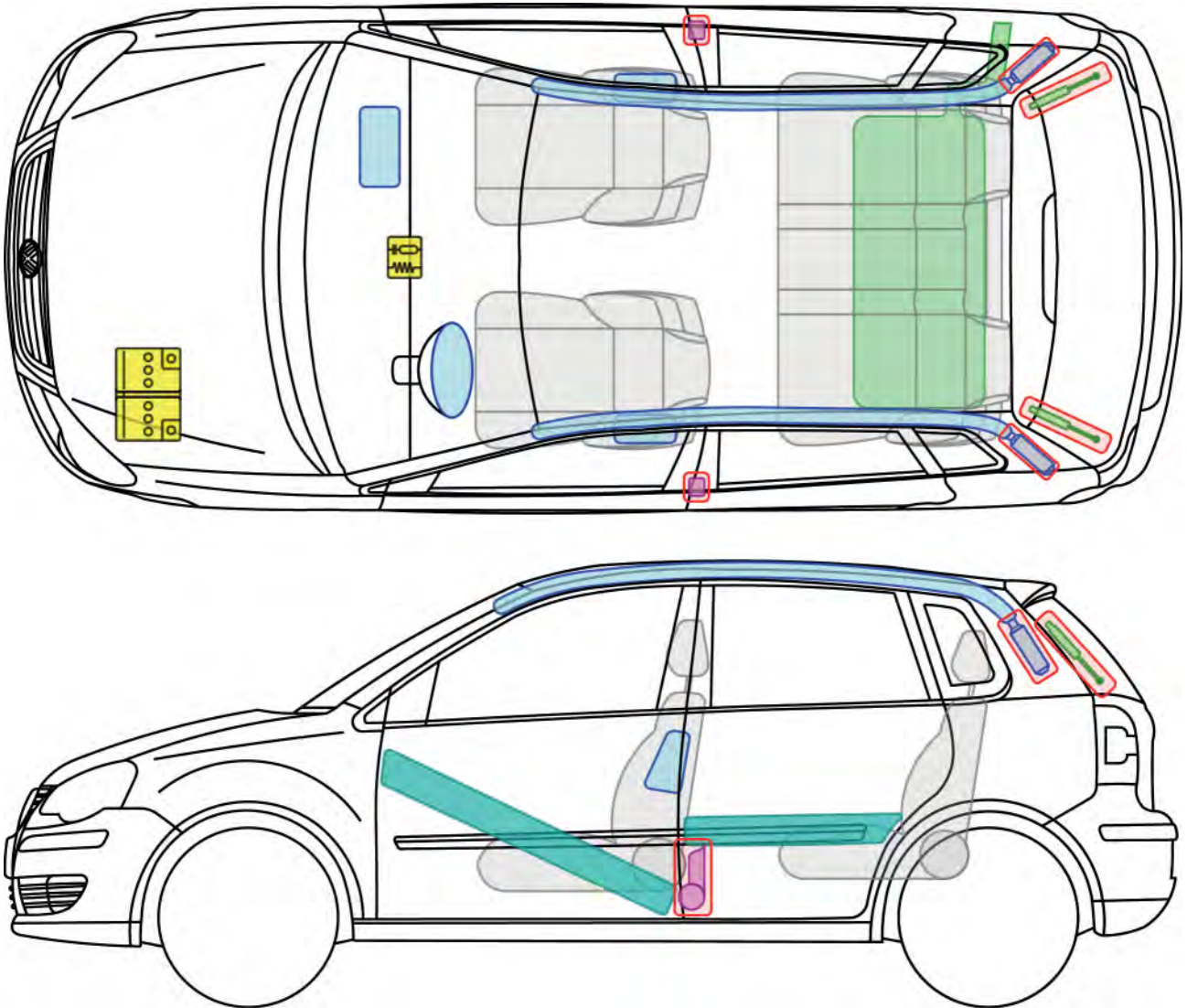



Polo A04

(5-Türer, ab 2001)



Legende

	Airbag		Karosserie-Verstärkung		Steuergerät
	Gas-generator				12V-Batterie
	Gurtstraffer		Gasdruck-dämpfer		Kraftstoff-tank







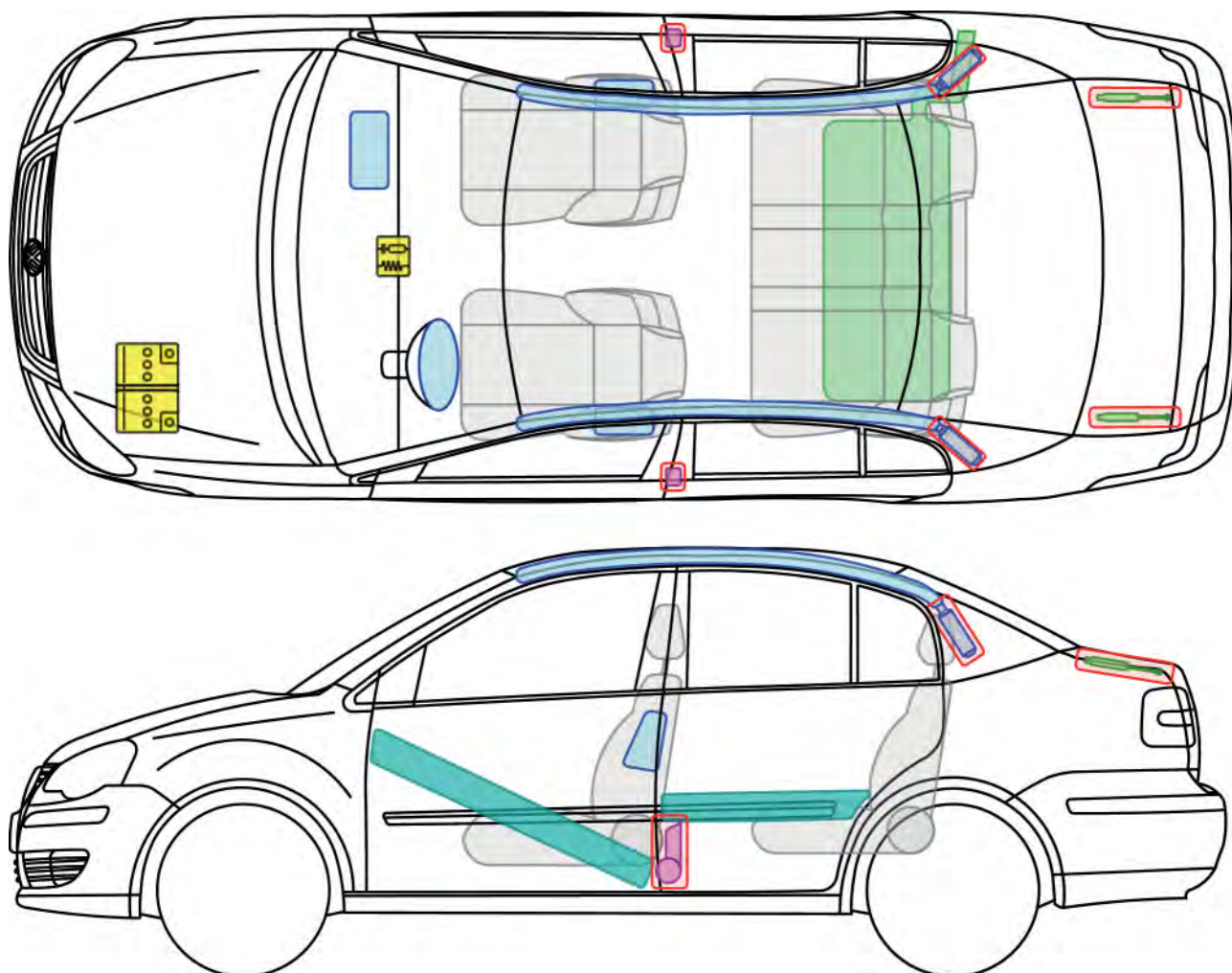



Polo A04

(Stufenheck, ab 2001)



Legende

	Airbag		Karosserie-Verstärkung		Steuergerät
	Gas-generator				12V-Batterie
	Gurtstraffer		Gasdruck-dämpfer		Kraftstoff-tank



Polo A05



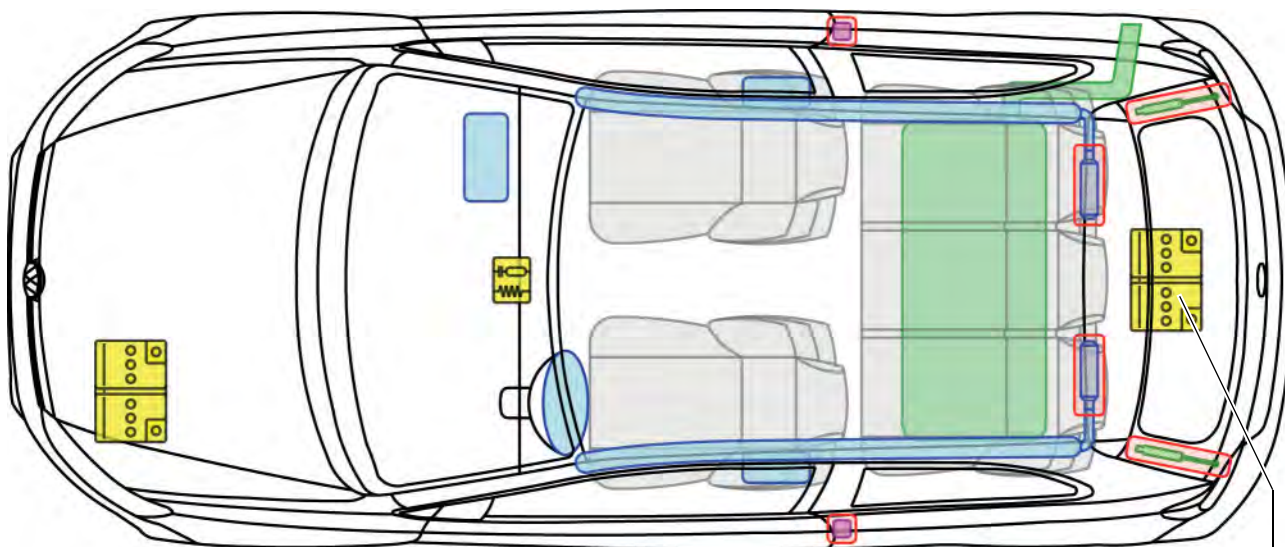



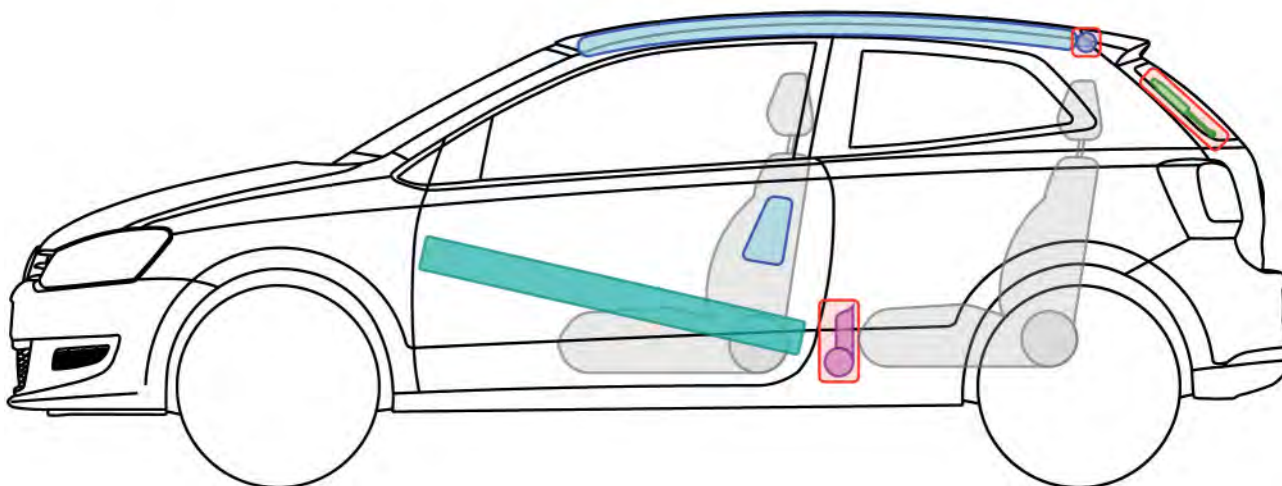

(3-Türer, ab 2009)



Polo A05 GTI Batterie im Kofferraum anstelle Motorraum



Legende

	Airbag		Karosserie-Verstärkung		Steuergerät
	Gas-generator				12V-Batterie
	Gurtstraffer		Gasdruck-dämpfer		Kraftstoff-tank







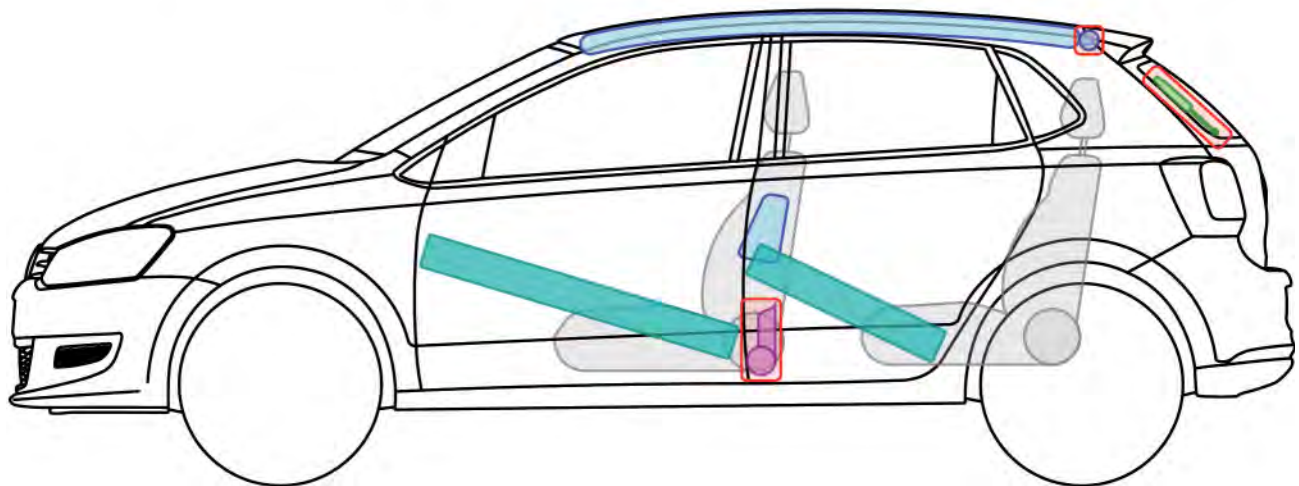
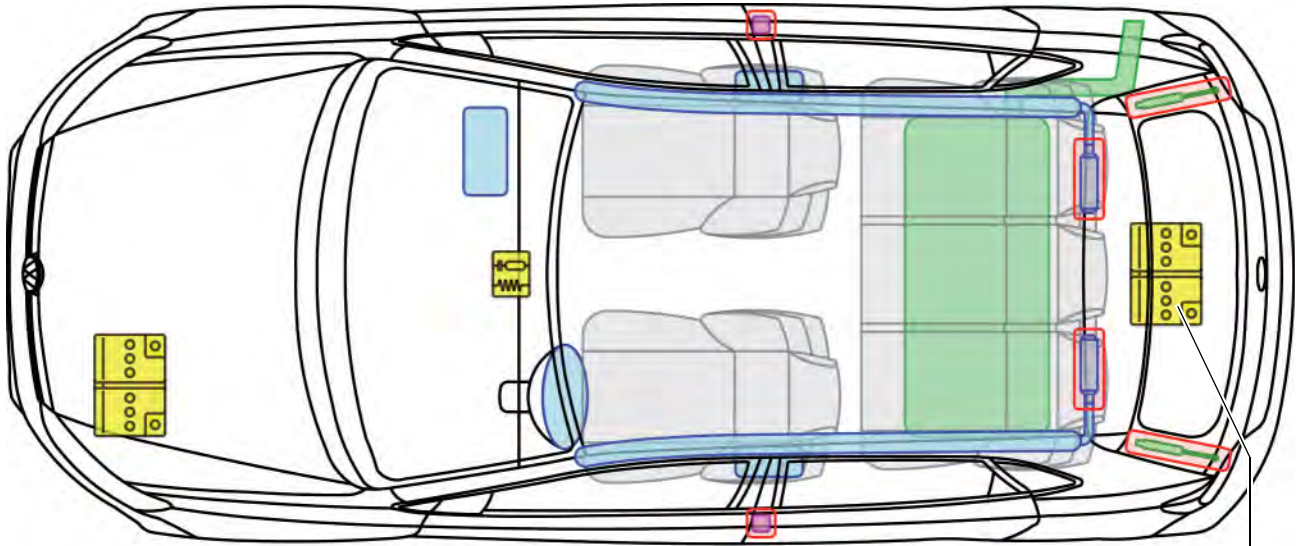



Polo A05

(5-Türer, ab 2009)



Legende

	Airbag		Karosserie-Verstärkung		Steuergerät
	Gas-generator				12V-Batterie
	Gurtstraffer		Gasdruck-dämpfer		Kraftstoff-tank



Polo A05

(3-Türer BiFuel, ab 2009)

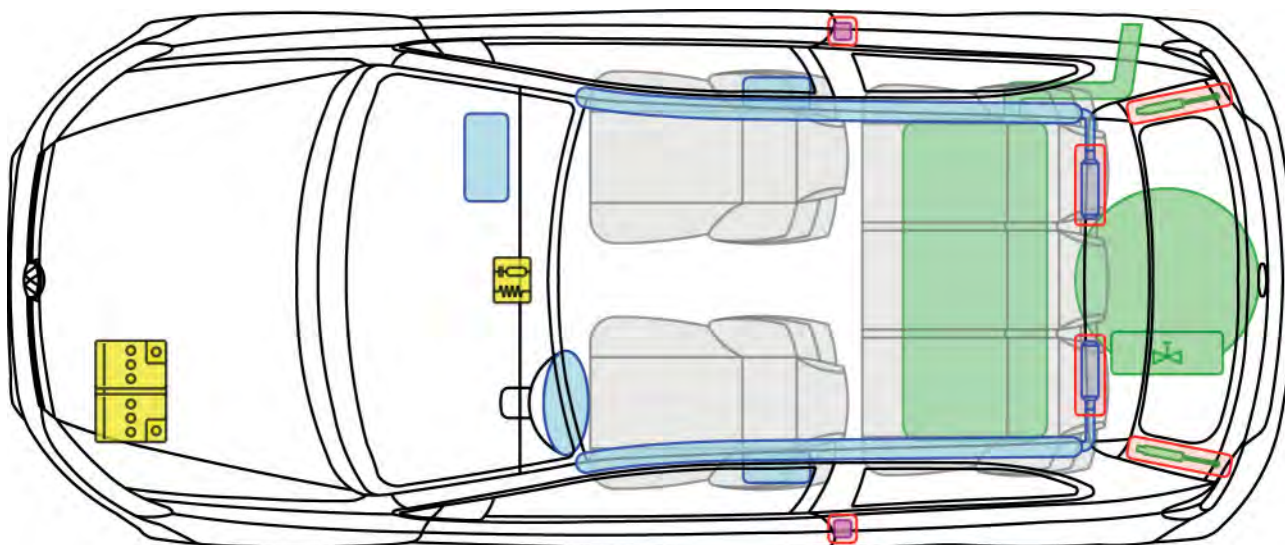





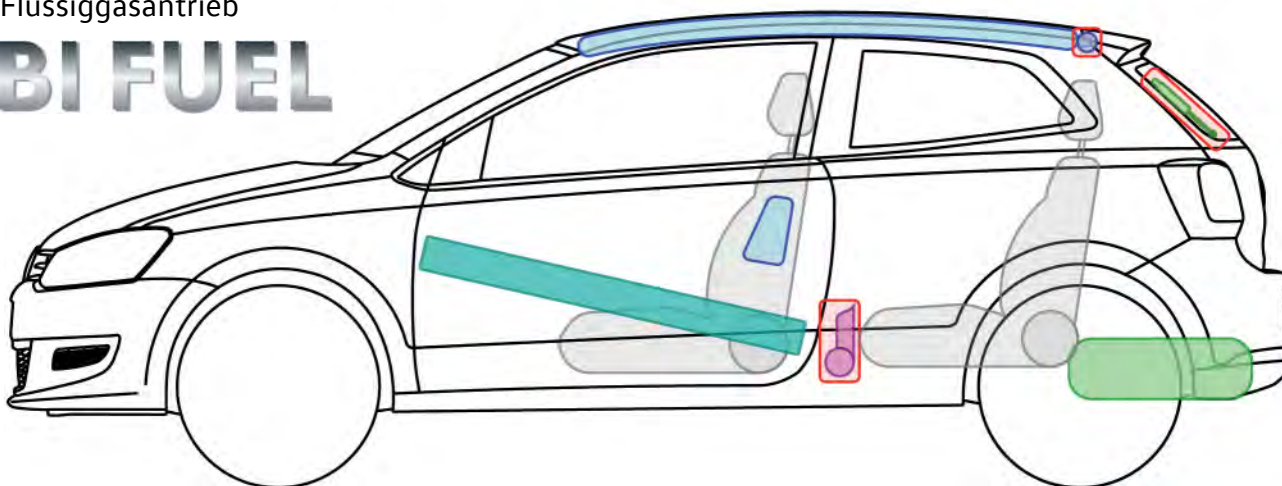





Flüssiggasantrieb

BI FUEL



Legende

	Airbag		Karosserie-Verstärkung		Steuergerät		Gastank
	Gas-generator				12V-Batterie		Sicherheits-ventil
	Gurtstraffer		Gasdruck-dämpfer		Kraftstoff-tank		



Polo A05

(3-Türer BiFuel, ab 2009)



Hinweise zur Flüssiggasanlage

Der Gastank der Flüssiggasanlage des Polo A05 BiFuel hat keine mechanische, manuelle Absperrmöglichkeit!



Der Flüssiggastank in der Reserveradmulde (Beispiel Golf)

1. Flüssiggastank lokalisieren

- Er ist unter dem Ladeboden in der Reserveradmulde montiert.
- Der Gastank verfügt nur über ein elektromagnetisches Absperrventil, das stromlos geschlossen ist.



Polo A05

(5-Türer BiFuel, ab 2009)

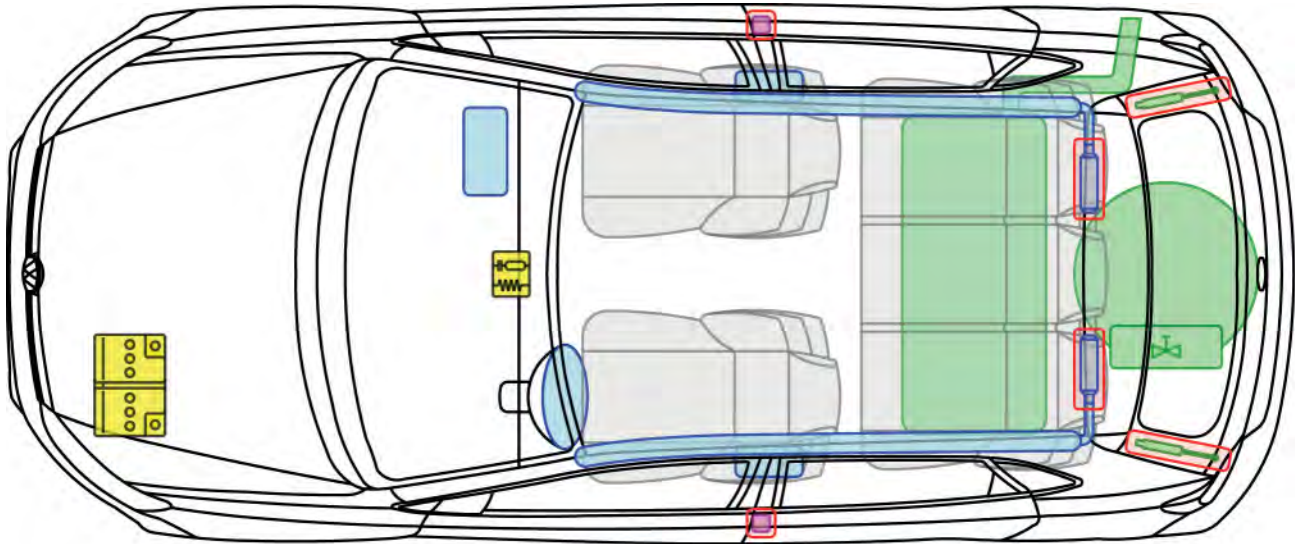





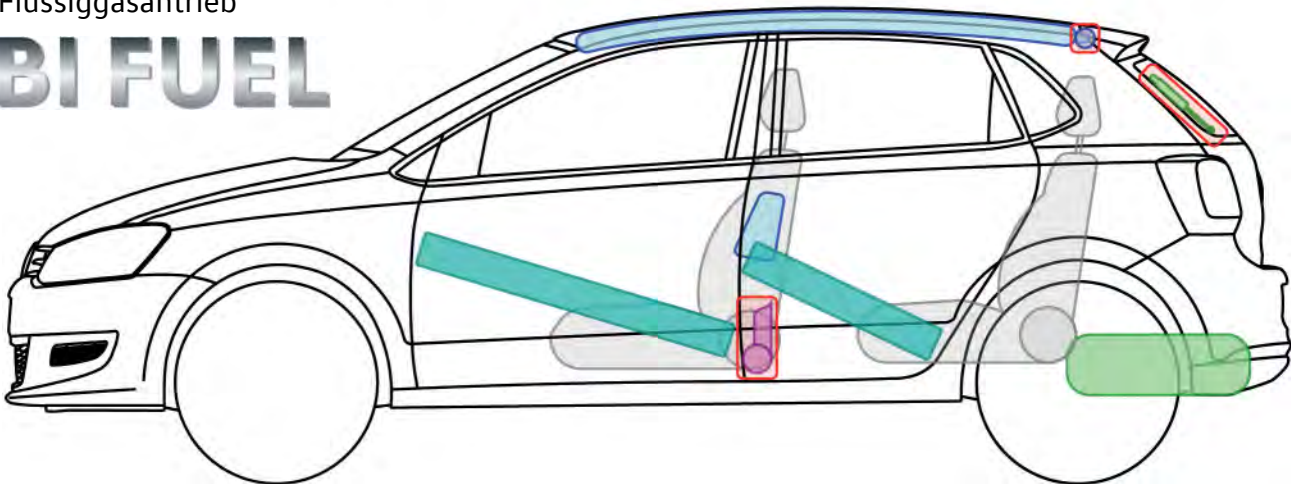





Flüssiggasantrieb

BI FUEL



Legende

	Airbag		Karosserie-Verstärkung		Steuergerät		Gastank
	Gas-generator				12V-Batterie		Sicherheits-ventil
	Gurtstraffer		Gasdruck-dämpfer		Kraftstoff-tank		





Polo A05

(5-Türer BiFuel, ab 2009)



Hinweise zur Flüssiggasanlage

Der Gastank der Flüssiggasanlage des Polo A05 BiFuel hat keine mechanische, manuelle Absperrmöglichkeit!



Der Flüssiggastank in der Reserveradmulde (Beispiel Golf)

1. Flüssiggastank lokalisieren

- Er ist unter dem Ladeboden in der Reserveradmulde montiert.
- Der Gastank verfügt nur über ein elektromagnetisches Absperrventil, das stromlos geschlossen ist.







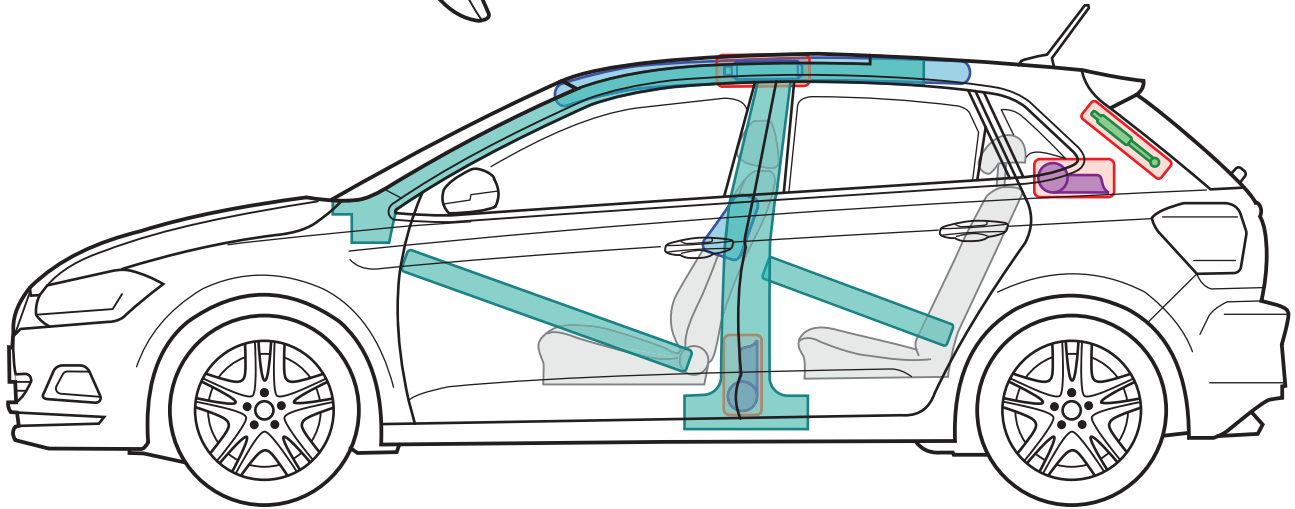
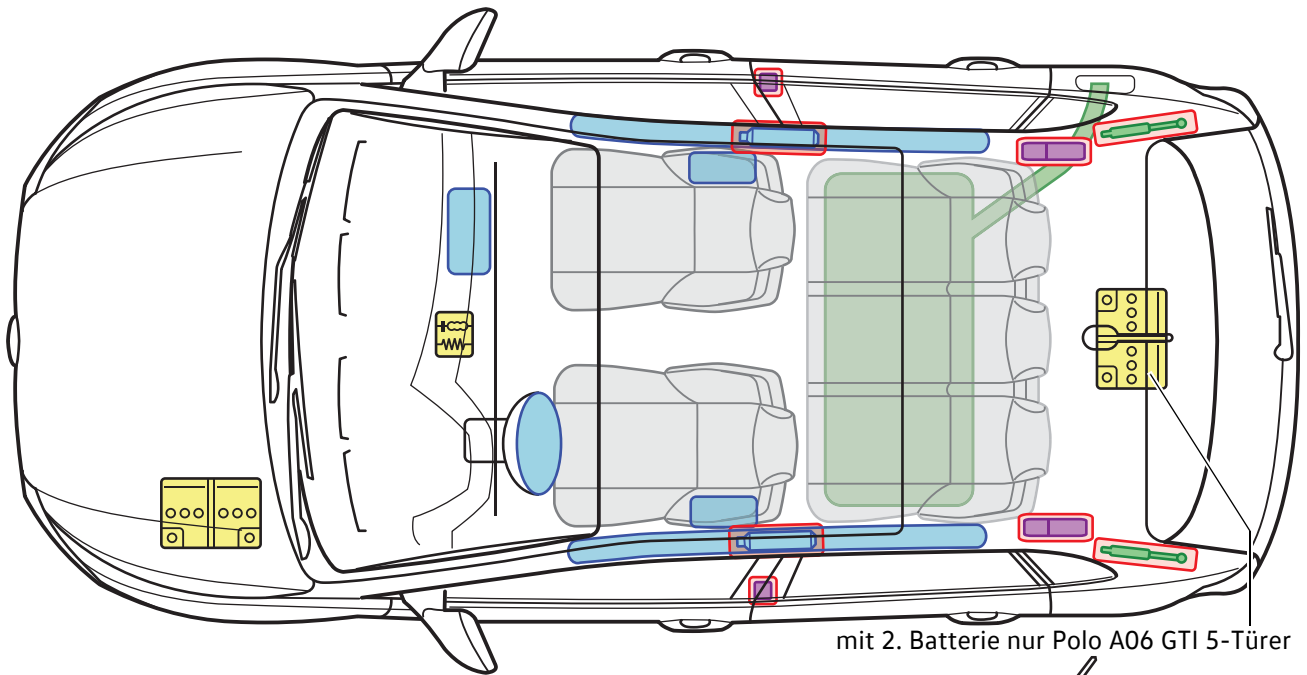



Polo A06

(5-Türer, ab 2017)



Legende

	Airbag		Karosserie-Verstärkung		Steuergerät
	Gas-generator				12V-Batterie
	Gurtstraffer		Gasdruck-dämpfer		Kraftstoff-tank







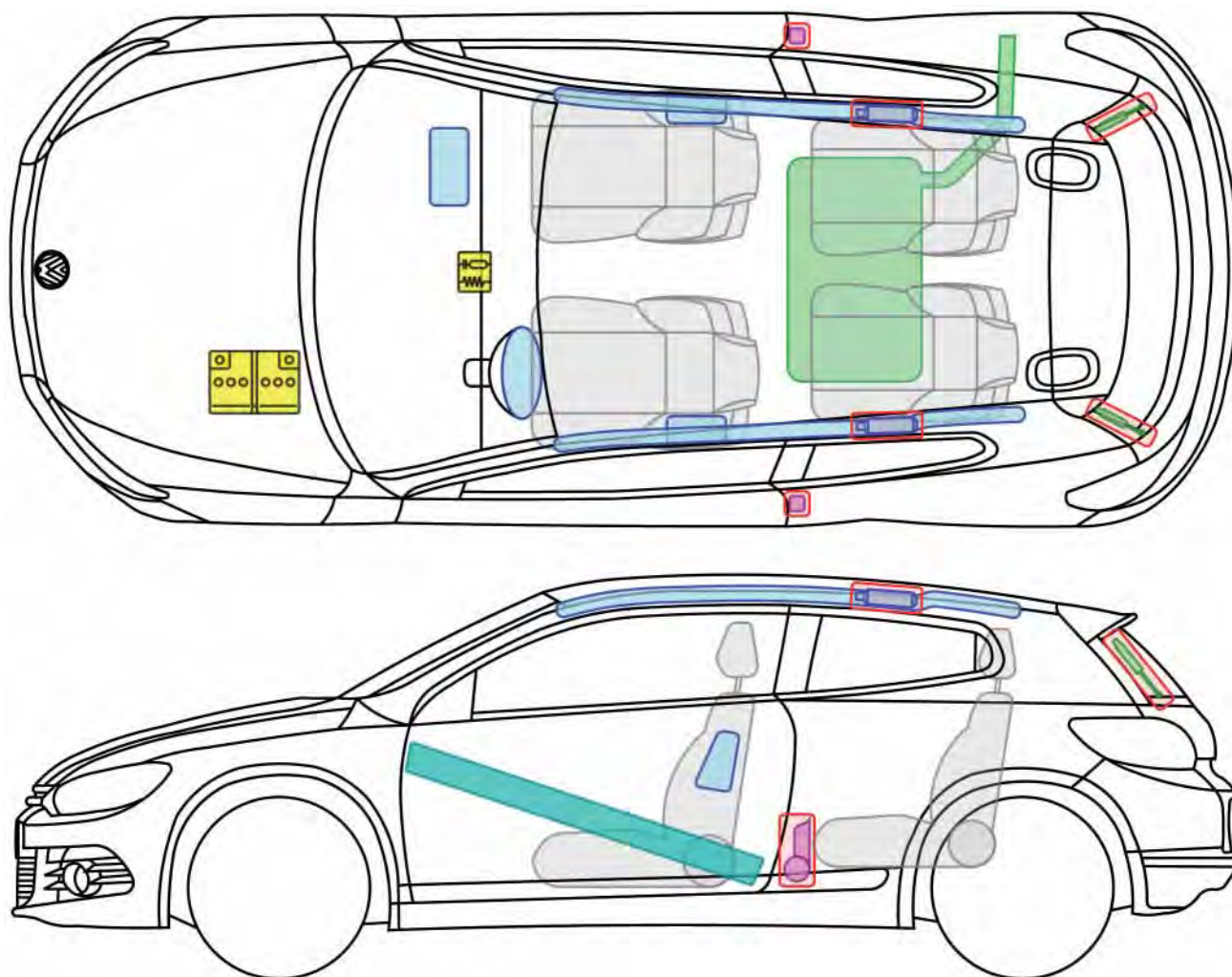



Scirocco

(ab 2008)



Legende

	Airbag		Karosserie-Verstärkung		Steuergerät
	Gas-generator				12V-Batterie
	Gurtstraffer		Gasdruck-dämpfer		Kraftstoff-tank



Sharan







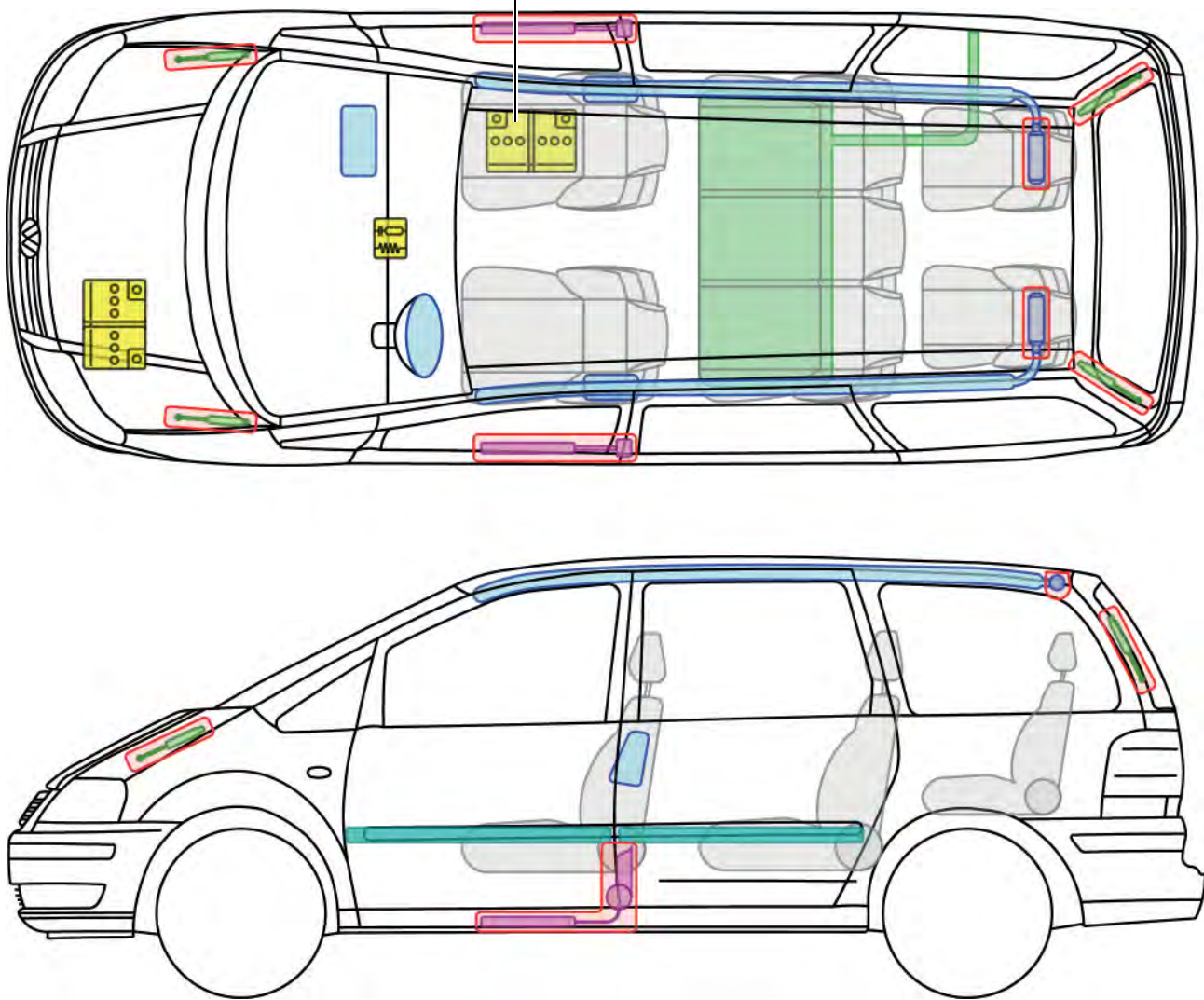

(ab 1995)



ausstattungsabhängig zusätzliche Batterie unter dem Beifahrersitz



Legende

	Airbag		Karosserie-Verstärkung		Steuergerät
	Gas-generator				12V-Batterie
	Gurtstraffer		Gasdruck-dämpfer		Kraftstoff-tank



Sharan

(BiFuel, ab 2006)



ausstattungsabhängig zusätzliche Batterie unter dem Beifahrersitz

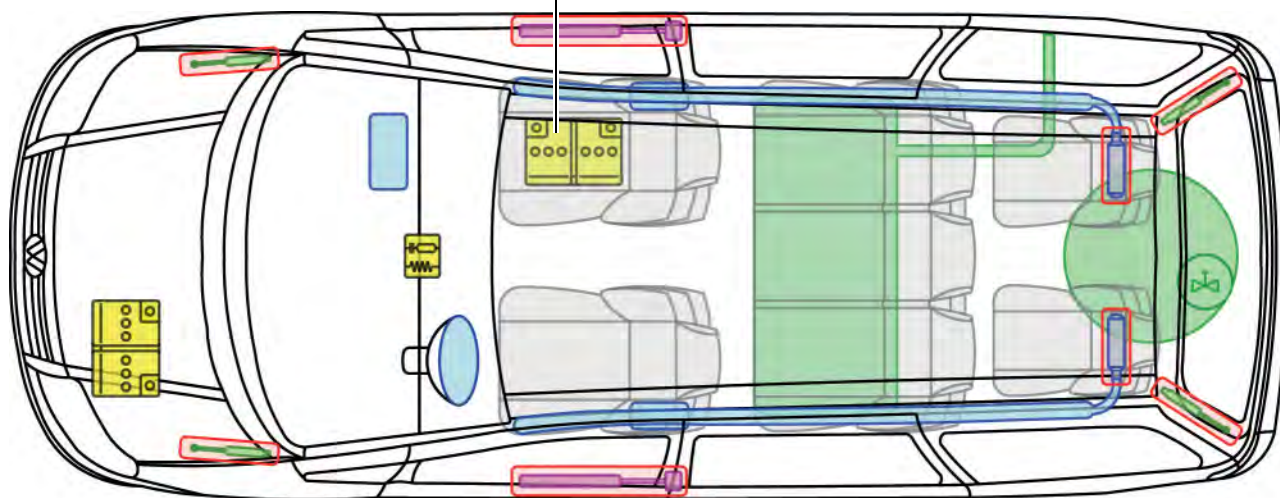





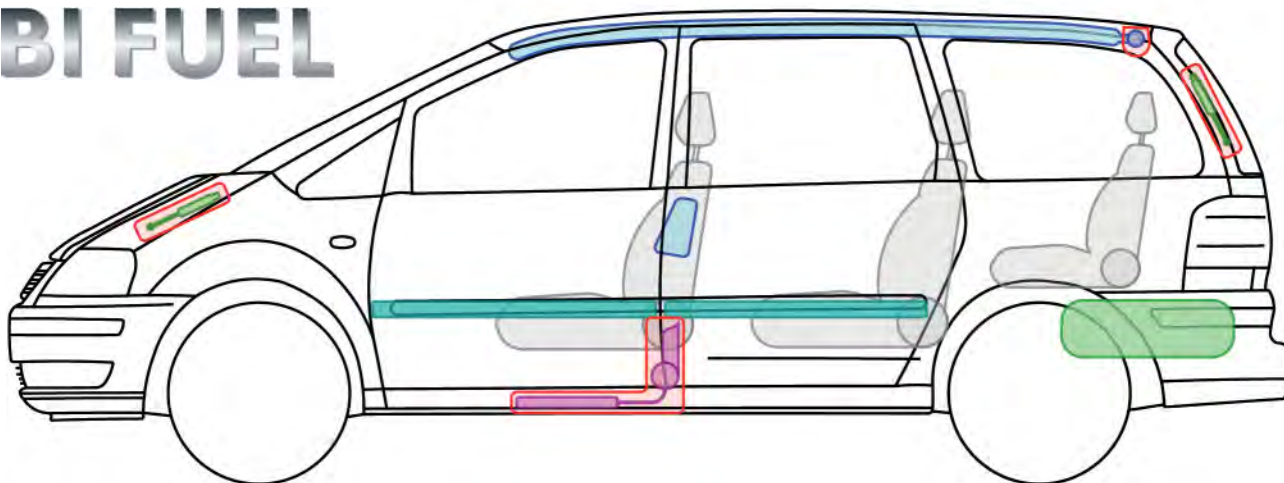





Flüssiggasantrieb

BI FUEL



Legende

	Airbag		Karosserie-Verstärkung		Steuergerät		Gastank
	Gas-generator				12V-Batterie		Sicherheits-ventil
	Gurtstraffer		Gasdruck-dämpfer		Kraftstoff-tank		



Sharan

(BiFuel, ab 2006)



Hinweise zur Flüssiggasanlage

Der Gastank der Flüssiggasanlage des Sharan 2006 BiFuel hat keine mechanische, manuelle Absperrmöglichkeit!



Der Flüssiggastank in der Reserveradmulde (Beispiel Golf)

1. Flüssiggastank lokalisieren

- Er ist unter dem Ladeboden in der Reserveradmulde montiert.
- Der Gastank verfügt nur über ein elektromagnetisches Absperrventil, das stromlos geschlossen ist.







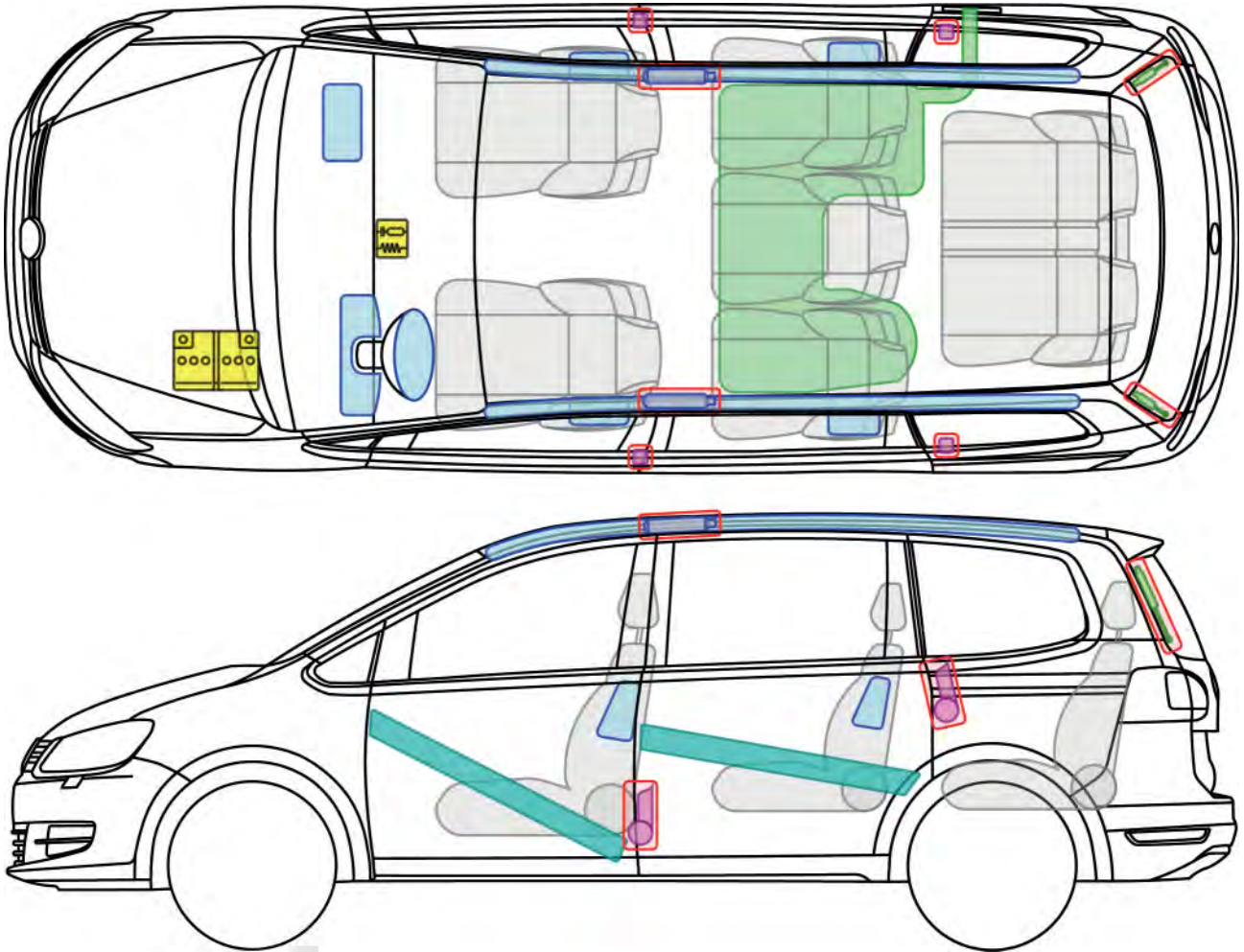



Sharan

(ab 2010)



Legende







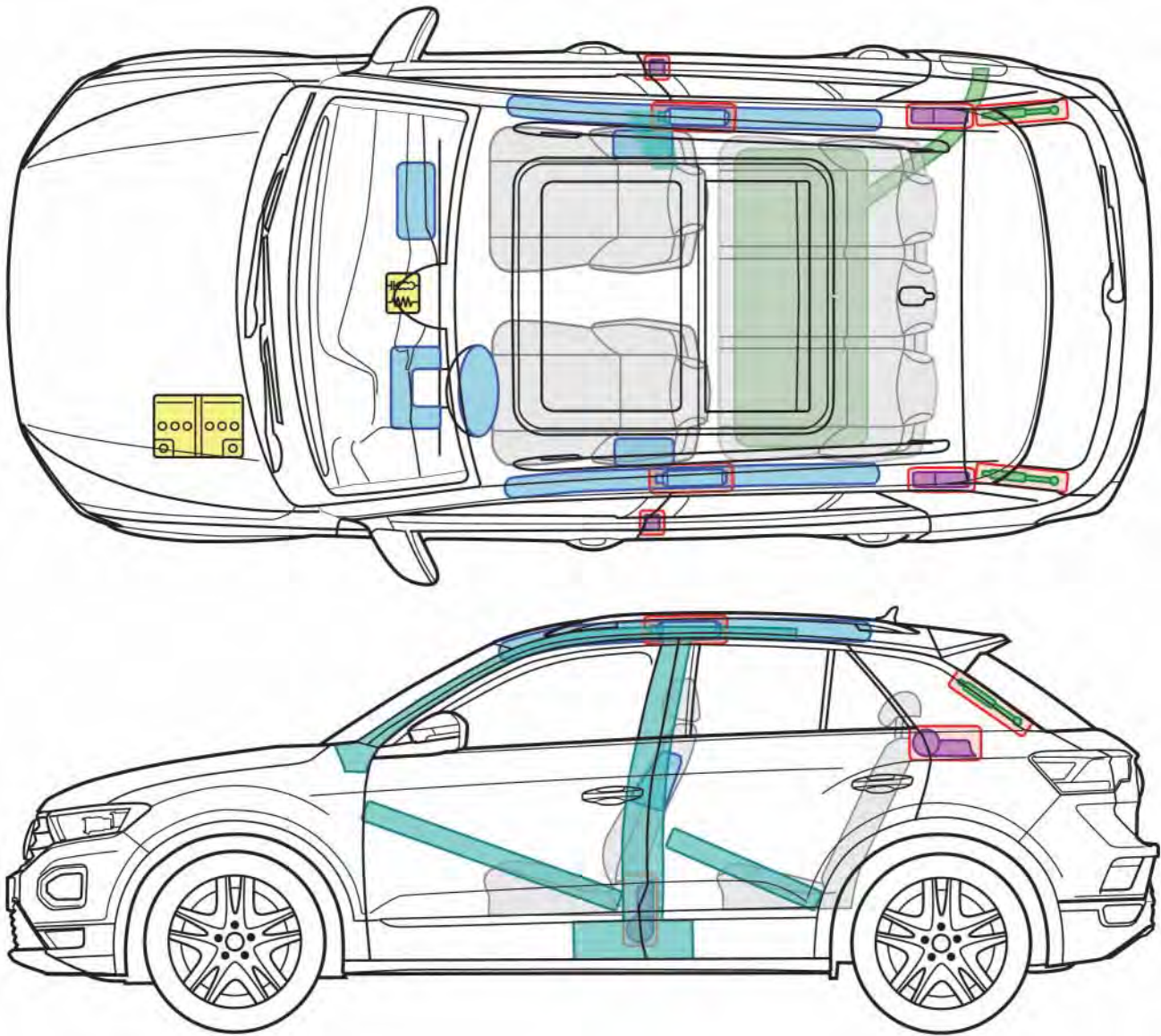

	Airbag		Karosserie-Verstärkung		Steuergerät
	Gas-generator				12V-Batterie
	Gurtstraffer		Gasdruck-dämpfer		Kraftstoff-tank



T-Roc (ab 2017)



Legende

	Airbag		Karosserie-Verstärkung		Steuergerät	
	Gas-generator				12V-Batterie	
	Gurtstraffer		Gasdruck-dämpfer		Kraftstoff-tank	







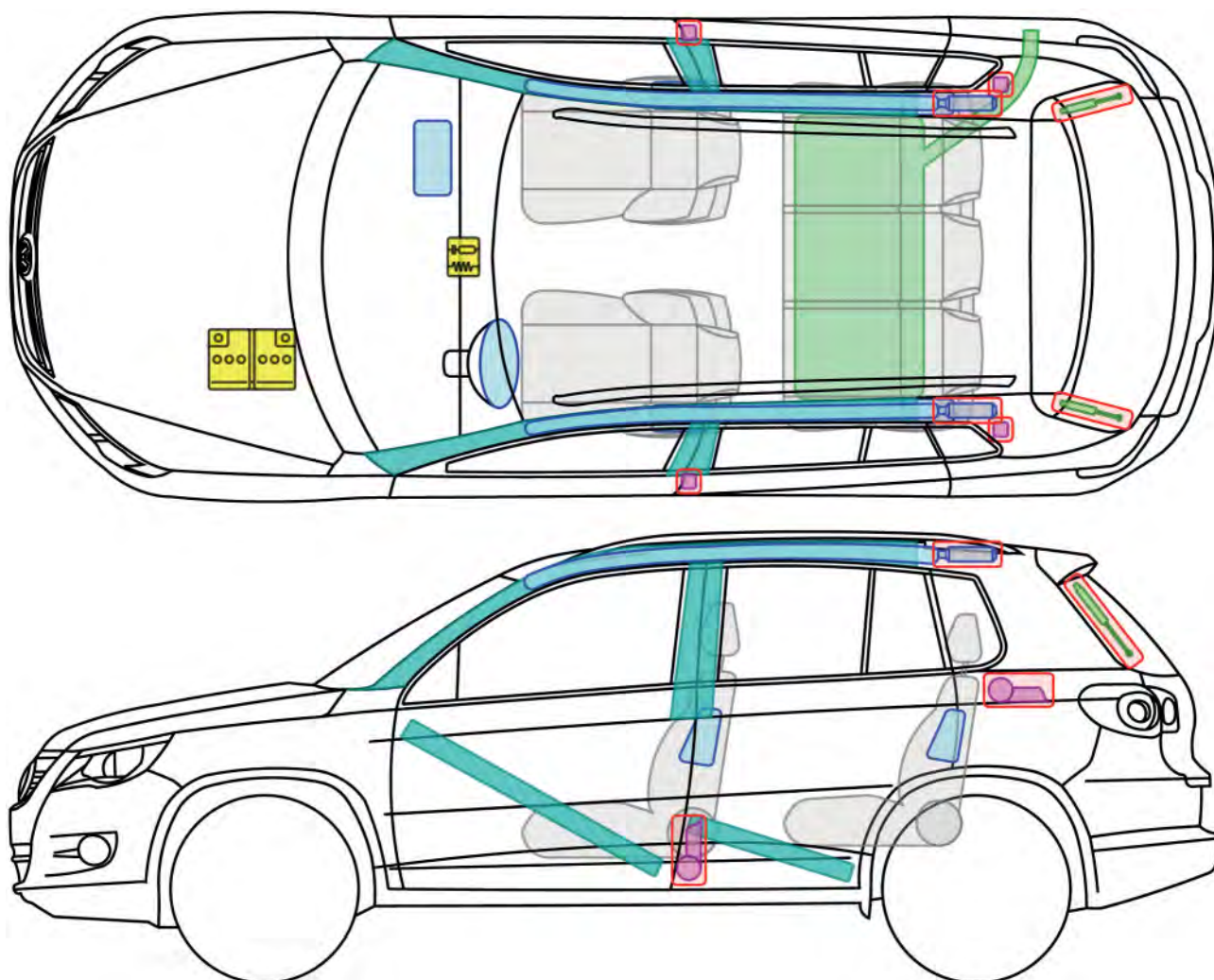



Tiguan

(ab 2007)



Legende

	Airbag		Karosserie-Verstärkung		Steuergerät
	Gas-generator				12V-Batterie
	Gurtstraffer		Gasdruck-dämpfer		Kraftstoff-tank



Tiguan



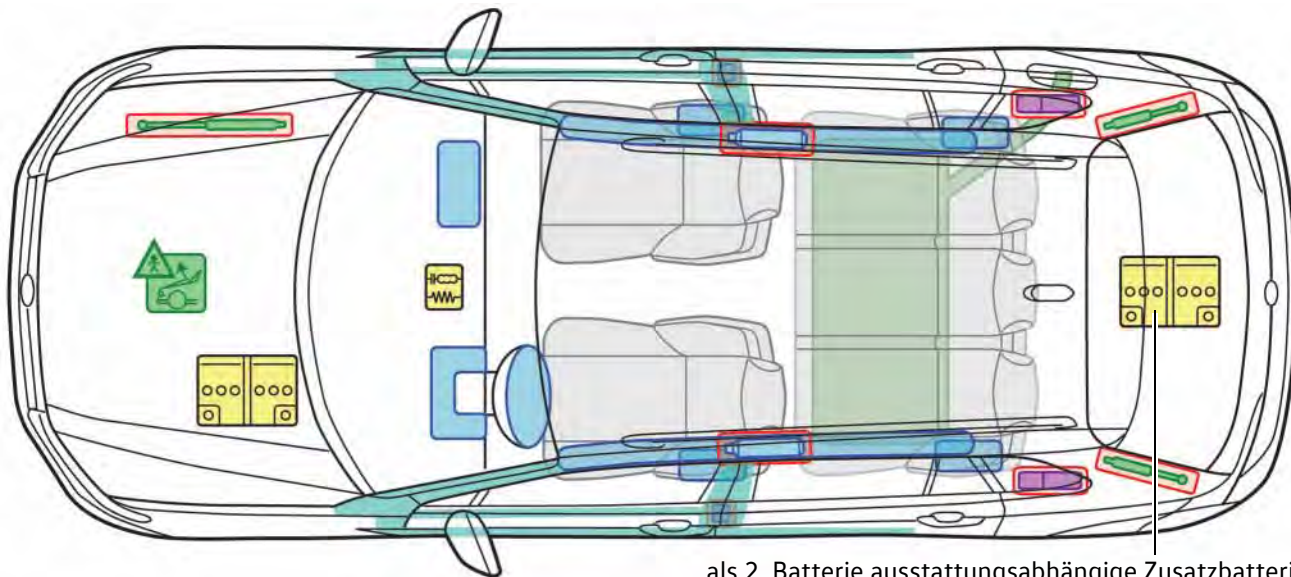



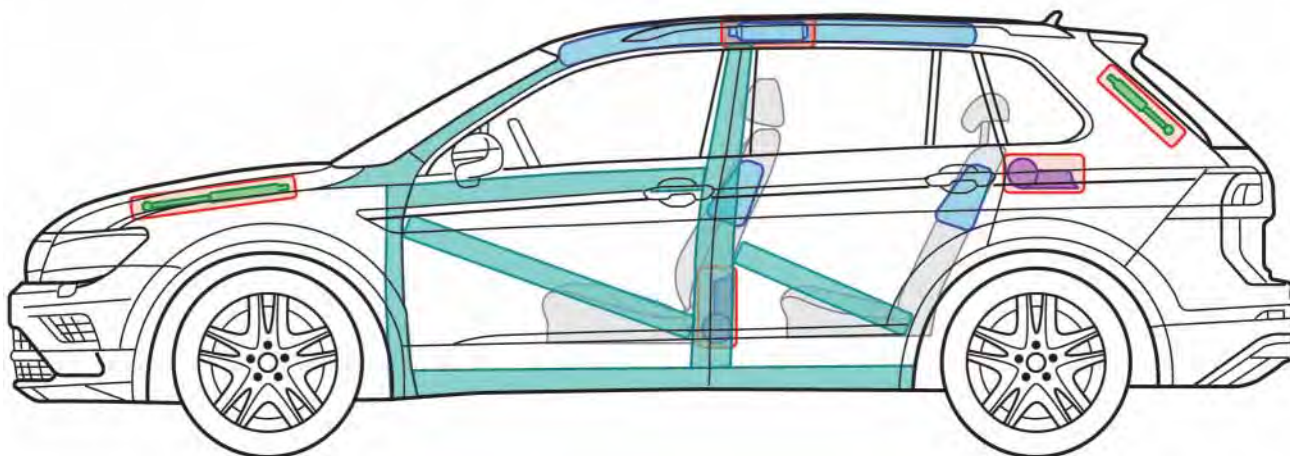

(ab 2016)



als 2. Batterie ausstattungsabhängige Zusatzbatterie



Legende

	Airbag		Karosserie-Verstärkung		Steuergerät
	Gas-generator				12V-Batterie
	Gurtstraffer		Gasdruck-dämpfer		Kraftstoff-tank
					aktive Frontklappe



Touareg



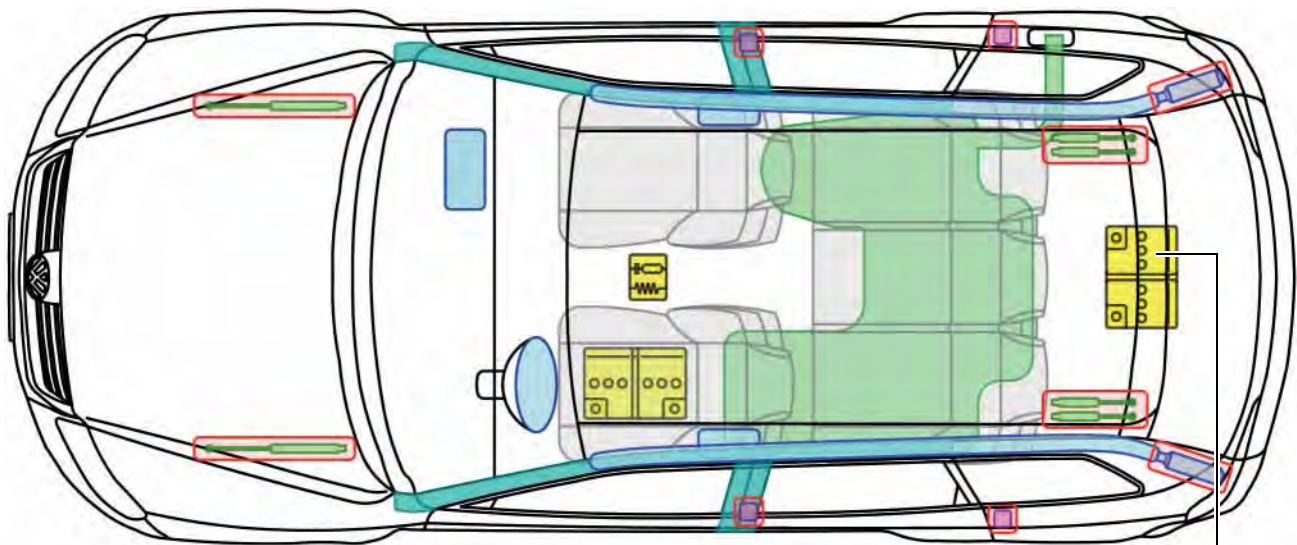



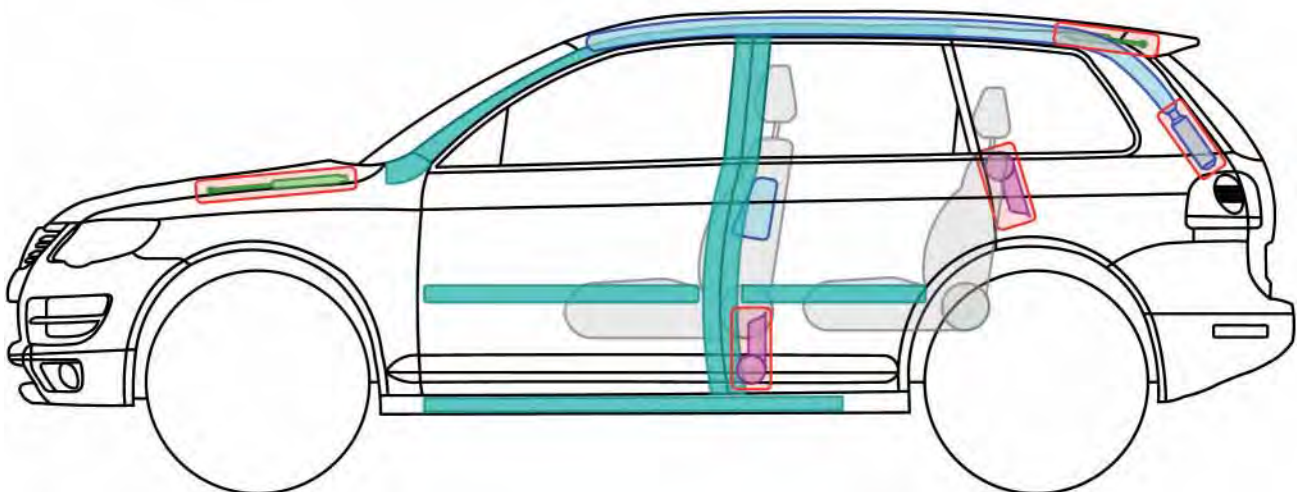

(2002 - 2010)



ausstattungsabhängige Zusatzbatterie im Kofferraum unter dem Reserverad



Legende

	Airbag		Karosserie-Verstärkung		Steuergerät
	Gas-generator				12V-Batterie
	Gurtstraffer		Gasdruck-dämpfer		Kraftstoff-tank



Fahrzeug deaktivieren

Batterien abklemmen

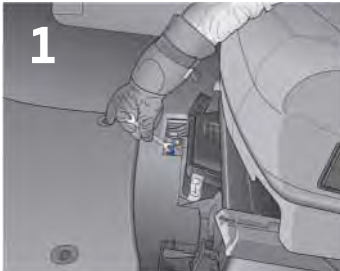

1. Startbatterie abklemmen

- Teppich vor dem Fahrersitz entfernen
- Masseanschluss der Startbatterie im Boden vor dem Fahrersitz lokalisieren
- Masseanschluss von der Karosserie trennen



2. Zusatzbatterie im Kofferraum lokalisieren

- Nach Möglichkeit Information einholen, ob Zusatzbatterie verbaut ist
- Ladeboden im Kofferraum anheben
- Reserverad entfernen

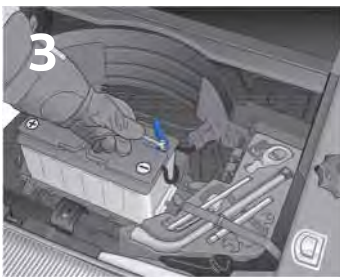

3. Zusatzbatterie am Masseanschluss (-) abklemmen







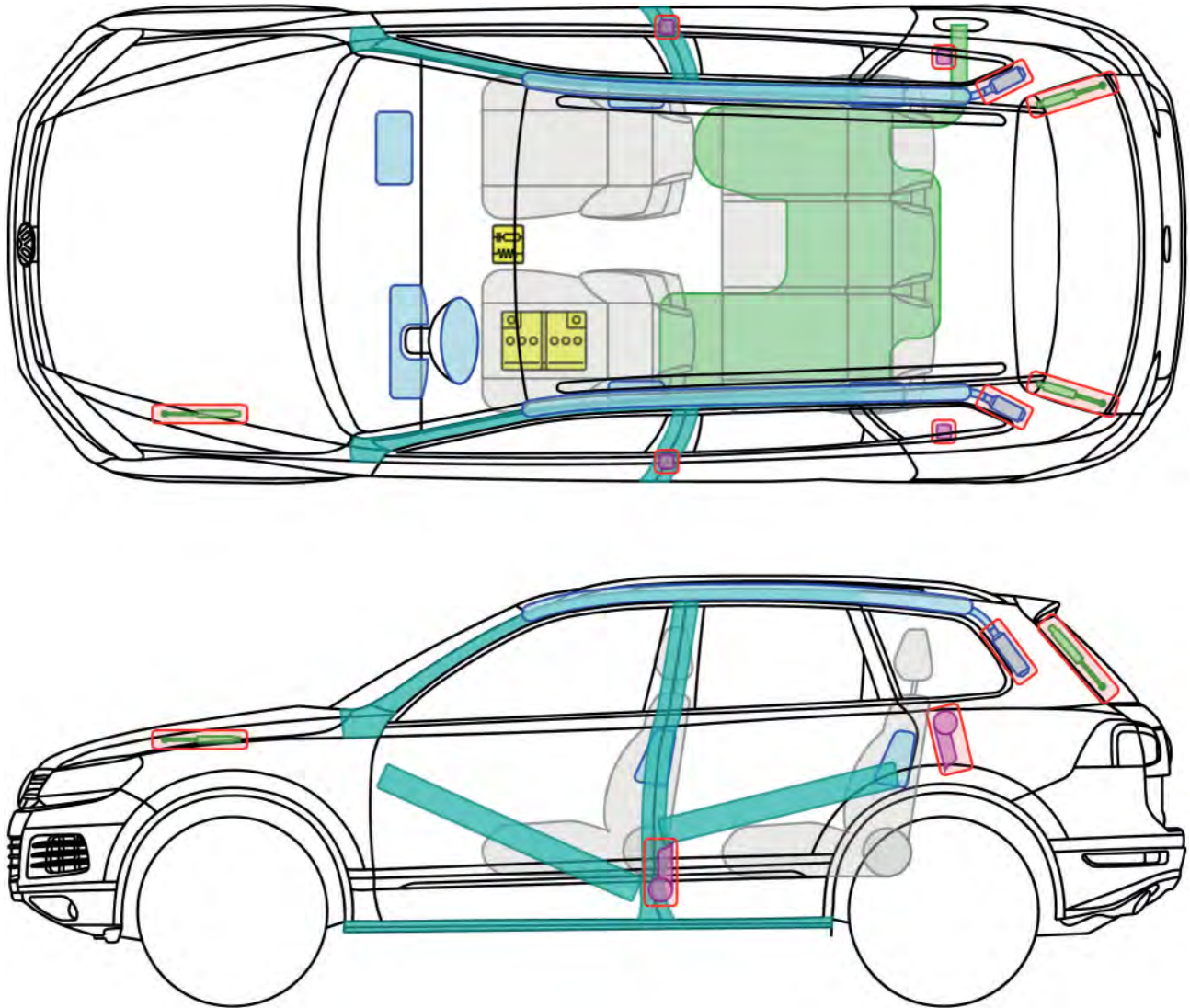



Touareg

(2010 - 2018)



Legende

	Airbag		Karosserie-Verstärkung		Steuergerät
	Gas-generator				12V-Batterie
	Gurtstraffer		Gasdruck-dämpfer		Kraftstoff-tank



Fahrzeug deaktivieren

Batterien abklemmen



1. Zugang zur Masseverbindung der 12V-Batterie lokalisieren.

- Fahrersitz, falls möglich, zurückfahren.
- Abdeckung der Masseverbindung im Boden vor dem Fahrersitz lokalisieren



2. Abdeckung (Teppichausschnitt) lösen und aufklappen

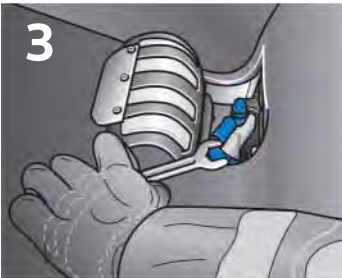

3. Masseverbindung an der Verschraubung trennen



Touareg

(Hybrid, ab 2010)

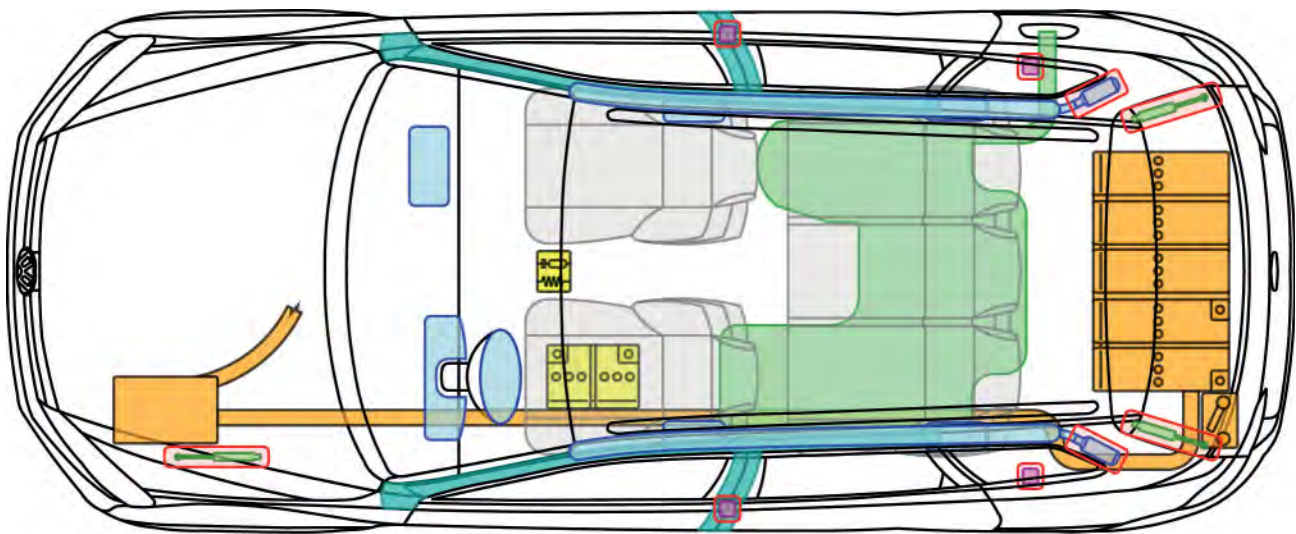





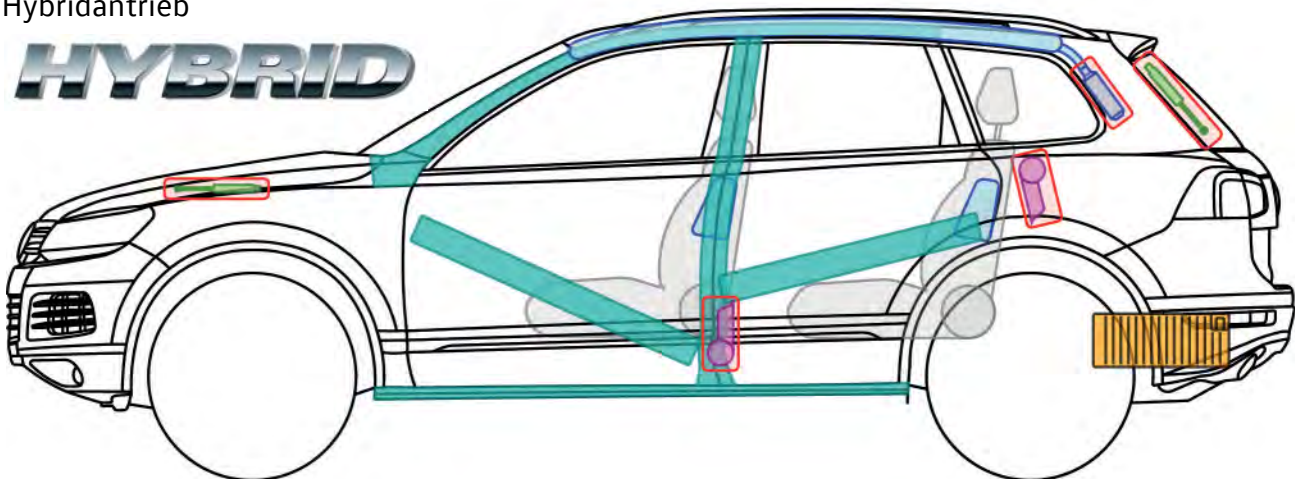





Hybridantrieb

HYBRID



Legende

	Airbag		Karosserie-Verstärkung		Steuergerät		Hochvolt-batterie
	Gas-generator				12V-Batterie		Hochvolt-leitung/-komponente
	Gurtstraffer		Gasdruck-dämpfer		Kraftstoff-tank		Trennstelle für Hochvolt



Touareg

(Hybrid, ab 2010)



Fahrzeugidentifizierung

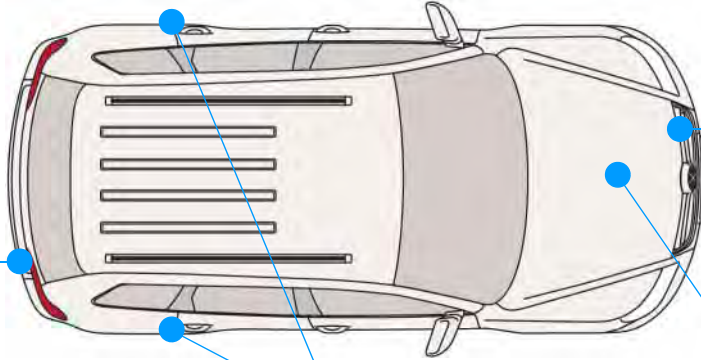

vorn im Kühlergrill

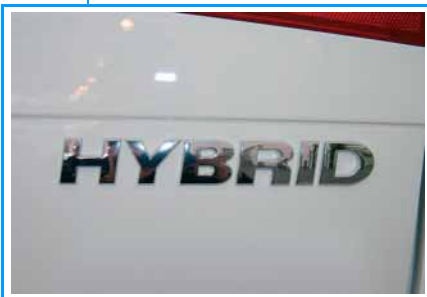

auf der Heckklappe



auf den seitlichen Chromleisten



auf der Designabdeckung

Fahrzeug gegen Wegrollen sichern



1. Gangwahlhebel in Stellung "P" bringen



2. Elektrische Feststellbremse betätigen

- Schalter nach oben ziehen

T

Touareg (Hybrid, ab 2010)



Fahrzeug deaktivieren

Antrieb und Hochvoltsystem deaktivieren (Zündung und 12V-Batterie zugänglich)

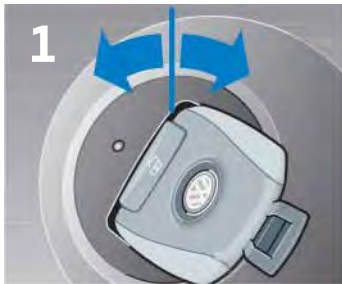

1. Bei laufendem Motor Zündschlüssel aus der Neutralstellung nach links oder rechts drehen, um Motor auszuschalten. Zündschlüssel nach Möglichkeit abziehen.

oder



2. Start/Stop-Knopf bis zur zweiten Stufe durchdrücken



3. Zugang zur Masseverbindung der 12V-Batterie lokalisieren. Fahrersitz, falls möglich, zurückfahren.



4. Teppichausschnitt lösen

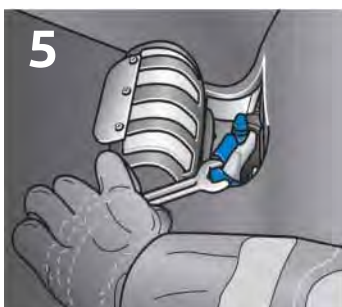

5. Masseverbindung an der Verschraubung trennen



Das Hochvoltsystem ist nach dem Ausschalten der Zündung innerhalb von ca. 20 Sekunden spannungsfrei. Die passiven Sicherheitssysteme wie Airbags und Gurtstraffer sind deaktiviert.



Fahrzeug deaktivieren

Hochvoltsystem deaktivieren

(Zündung und 12V-Batterie NICHT zugänglich)

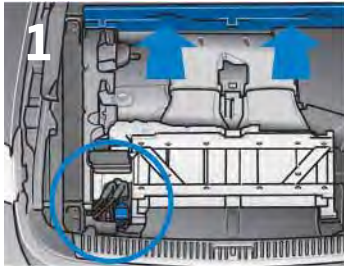

1. Ladeboden des Kofferraumes anheben

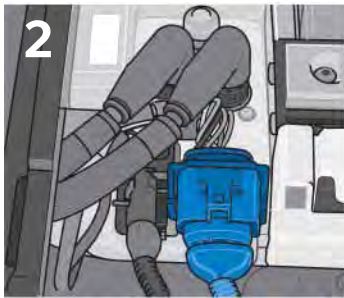

2. Trennstelle lokalisieren

- Die zu trennende 12V-Steckverbindung befindet sich an der E-Box auf der linken Seite der Hochvoltbatterie neben der Hochvoltleitung

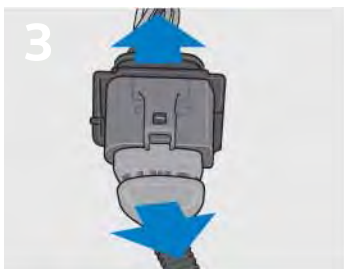

3. Steckverbindung trennen



Das Hochvoltsystem ist nach dem Trennen der Steckverbindung innerhalb von ca. 20 Sekunden spannungsfrei.

Die passiven Sicherheitssysteme wie Airbags und Gurtstraffer werden durch die 12V-Batterie weiterhin mit Spannung versorgt.

Bei Unfällen mit Airbag und/oder Gurtstraffer-auslösung wird das Hochvoltsystem automatisch deaktiviert.



Touareg







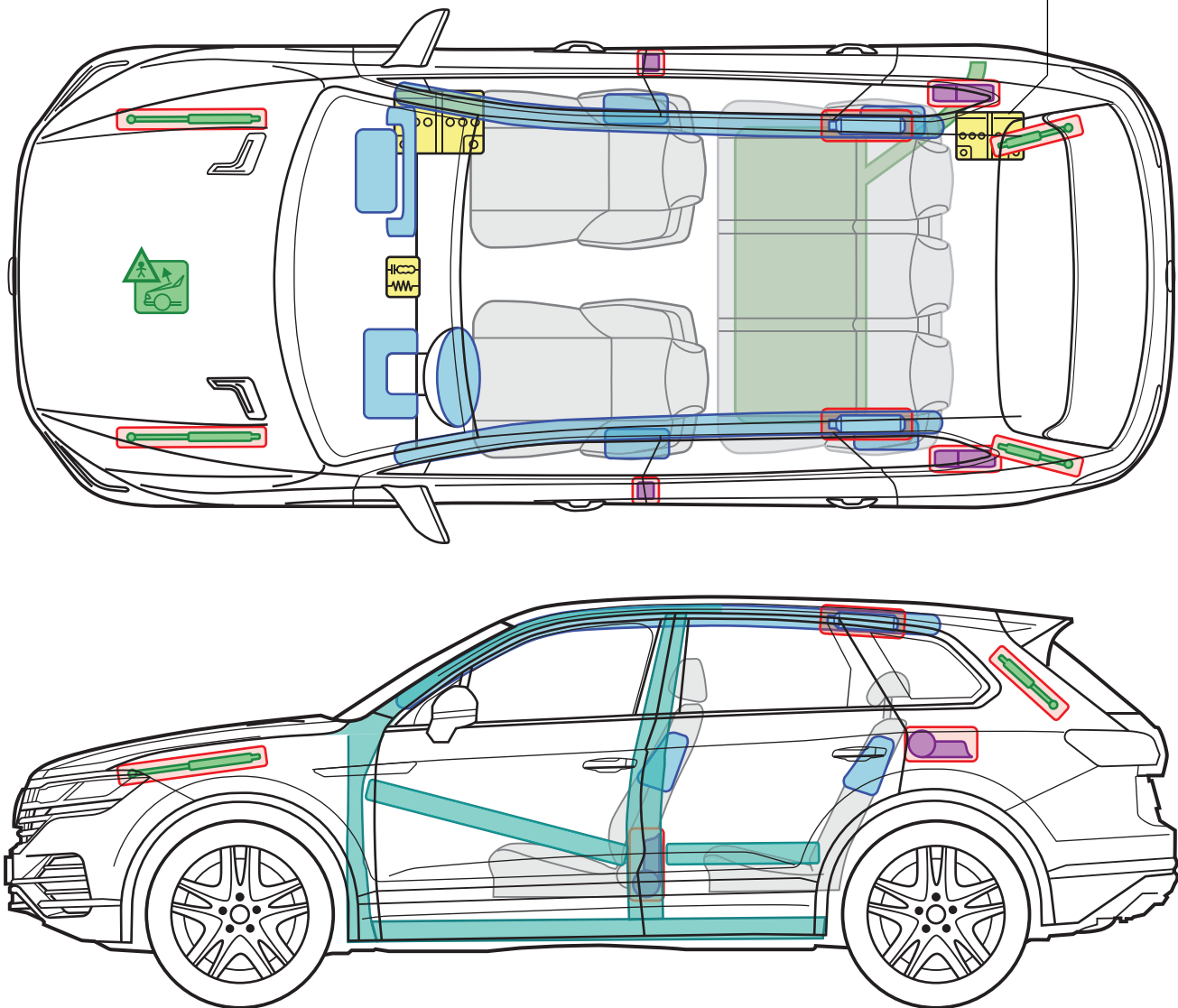

(ab 2018)



zusätzliche 48-Volt-Batterie bei Ausstattung mit Wankstabilisierung



Legende

	Airbag		Karosserie-Verstärkung		Steuergerät
	Gas-generator				12V-Batterie
	Gurtstraffer		Gasdruck-dämpfer		Kraftstoff-tank
					aktive Frontklappe



Fahrzeug deaktivieren

Batterien abklemmen



1. Zugang zur Masseverbindung der 12V-Batterie lokalisieren.

- Beifahrersitz, falls möglich, zurückfahren.
- Abdeckung der Masseverbindung im Boden vor dem Fahrersitz lokalisieren



2. Abdeckung (Teppichausschnitt) lösen und aufklappen

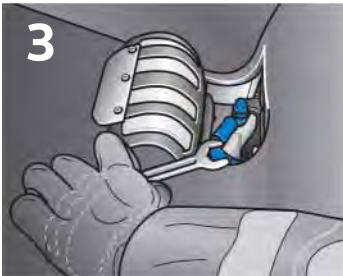

3. Masseverbindung an der Verschraubung trennen







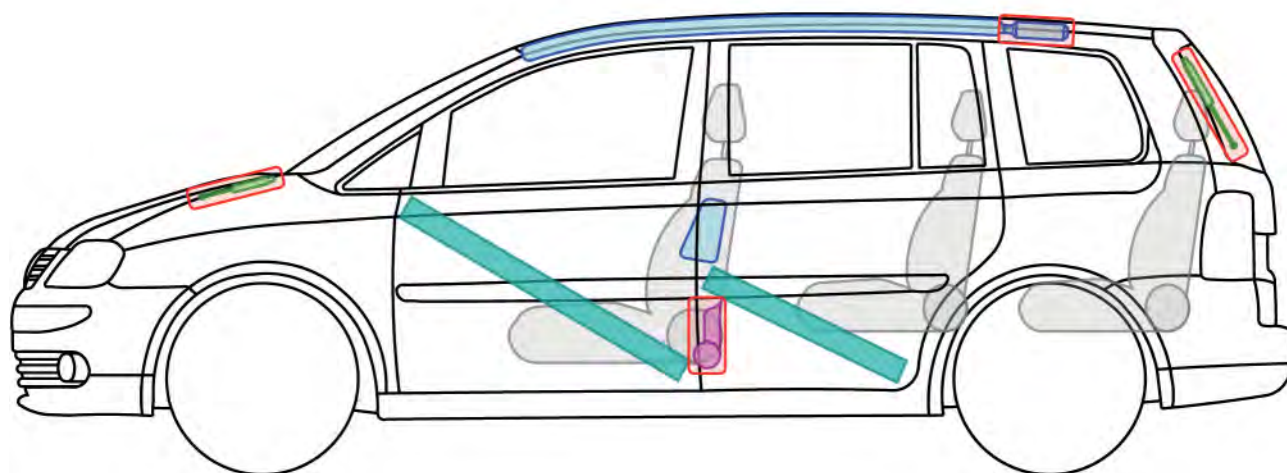
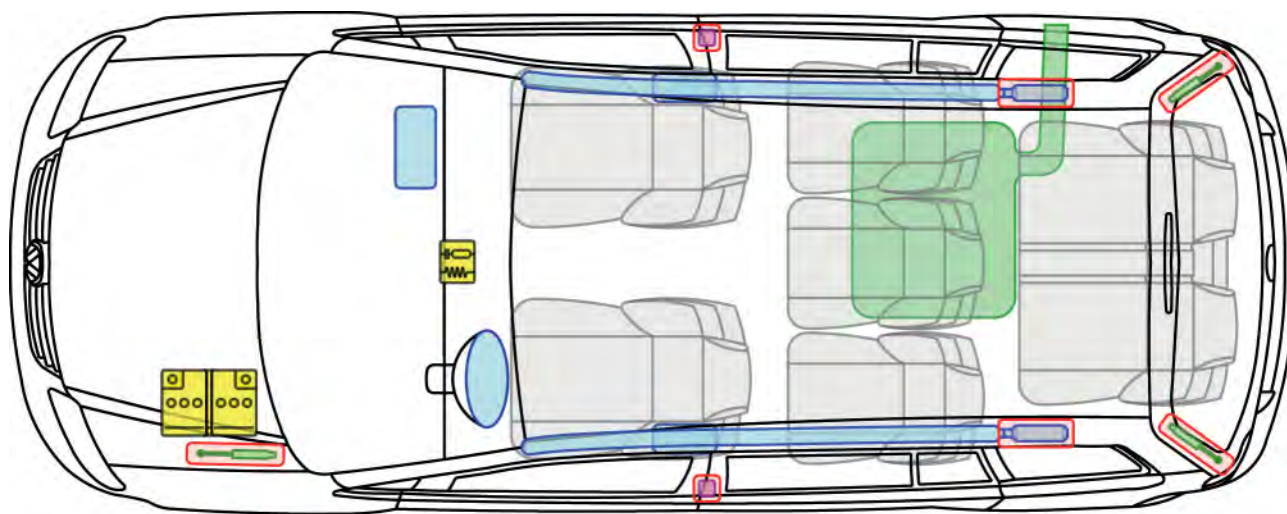



Touran

(ab 2003)



Legende

	Airbag		Karosserie-Verstärkung		Steuergerät
	Gas-generator				12V-Batterie
	Gurtstraffer		Gasdruck-dämpfer		Kraftstoff-tank



Touran

(EcoFuel, ab 2005)

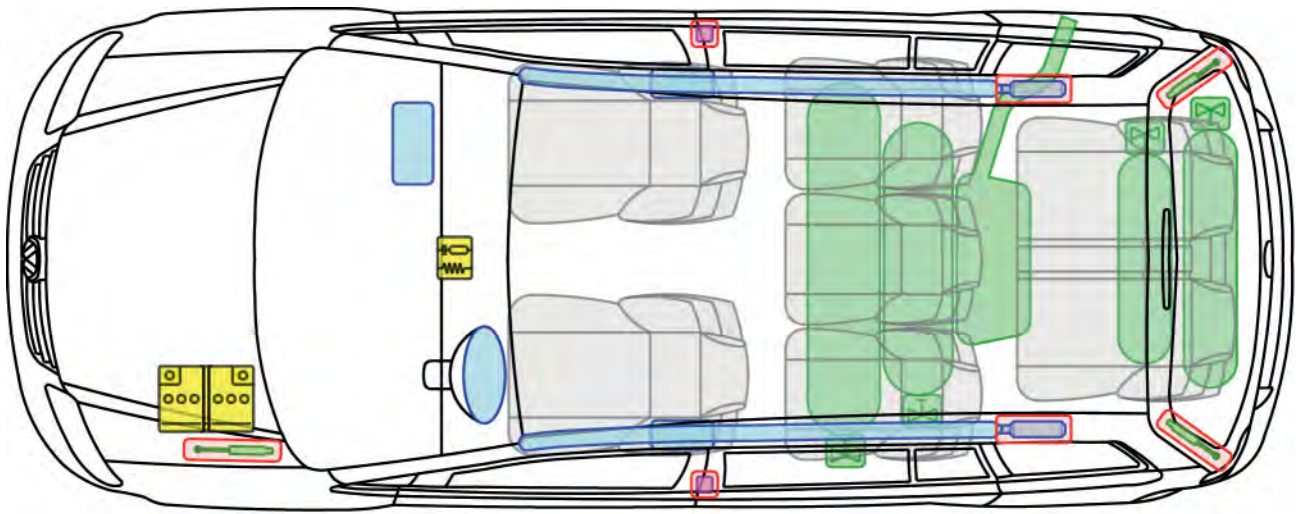





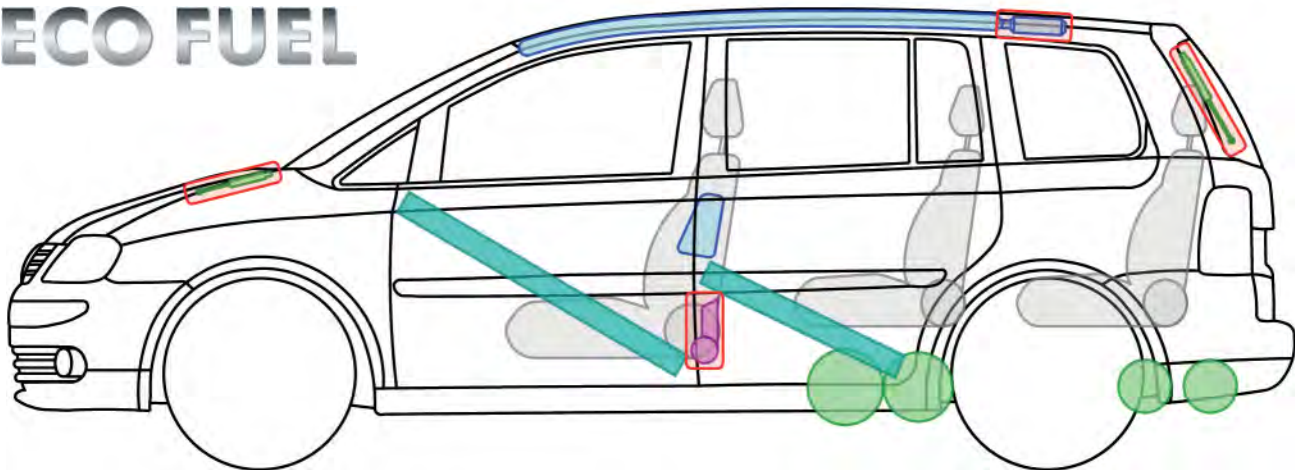





Erdgasantrieb

ECO FUEL



Legende

	Airbag		Karosserie-Verstärkung		Steuergerät		Gastank
	Gas-generator				12V-Batterie		Sicherheits-ventil
	Gurtstraffer		Gasdruck-dämpfer		Kraftstoff-tank		

T

Touran (EcoFuel, ab 2005)



Hinweise zur Erdgasanlage

Gastanks manuell absperren (bei Gasgeruch bzw. Austritt von Erdgas)

1. Zugang zu den Erdgastanks

- Der Zugang zu den Tanks erfolgt vom Unterboden aus.
- Die Gastanks sind durch eine Kunststoffabdeckung verkleidet. Um an die Erdgastanks zu gelangen, muss diese Abdeckung mit geeigneten Mitteln entfernt werden, ohne die darunter liegenden Bauteile der Gasanlage zu beschädigen.



elektromagnetische Absperrventile an den Gastanks

2. Absperrhähne lokalisieren

- Jeder Gastank besitzt ein eigenes Flaschenventil mit einem manuellen Absperrhahn.
- Falls einsatzbedingt erforderlich muss jeder Gastank separat abgesperrt werden.



manueller Absperrhahn seitlich am Flaschenventil (bis 2008).

3. Gastank von Hand schließen

- Falls einsatzbedingt erforderlich muss jeder Gastank separat abgesperrt werden.
- Mit einem 5er-Maul- bzw. Ringschlüssel lässt sich das manuelle Absperrventil am Vierkant durch Drehen im Uhrzeigersinn bis zum Anschlag des Ventils verschließen.







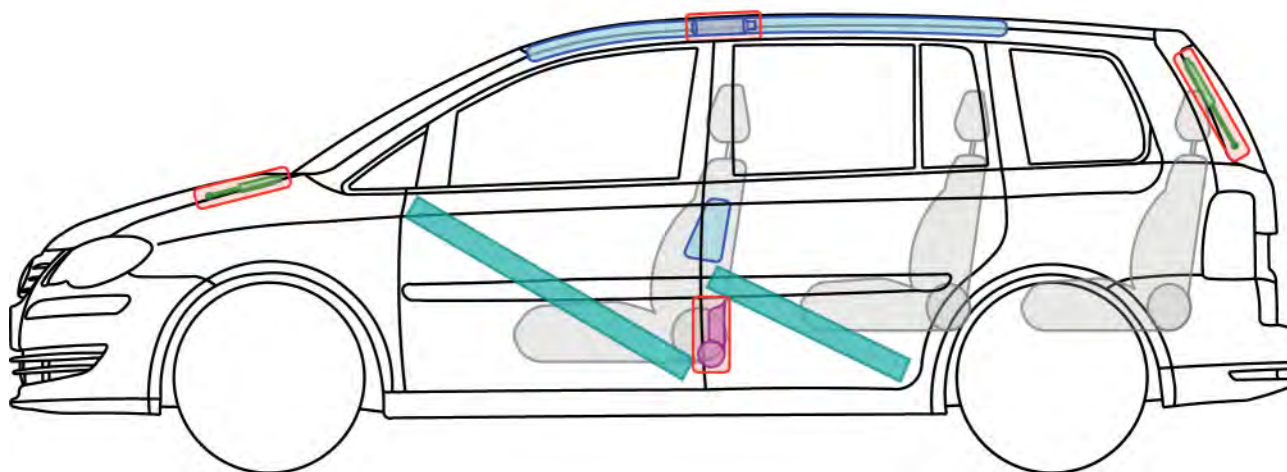
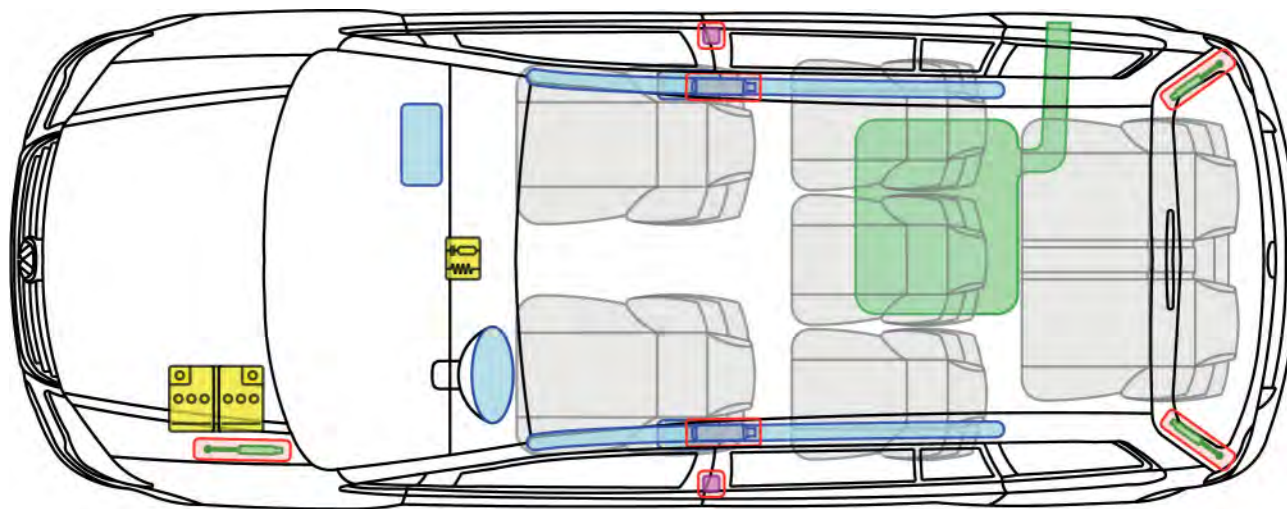



Touran

(ab 2006)



Legende

	Airbag		Karosserie-Verstärkung		Steuergerät
	Gas-generator				12V-Batterie
	Gurtstraffer		Gasdruck-dämpfer		Kraftstoff-tank



Touran

(EcoFuel, ab 2006)

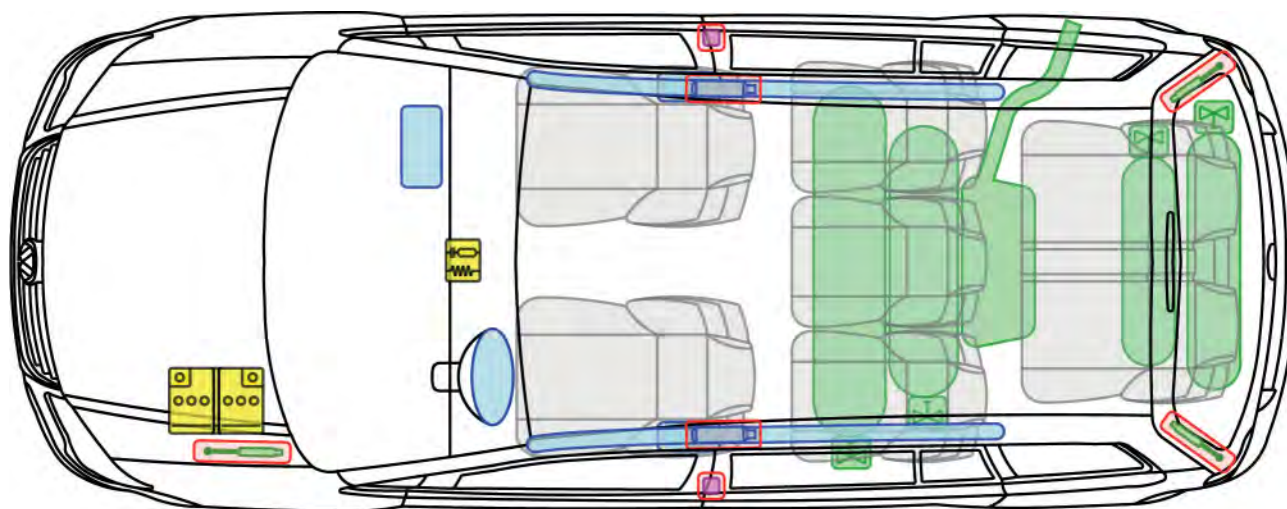





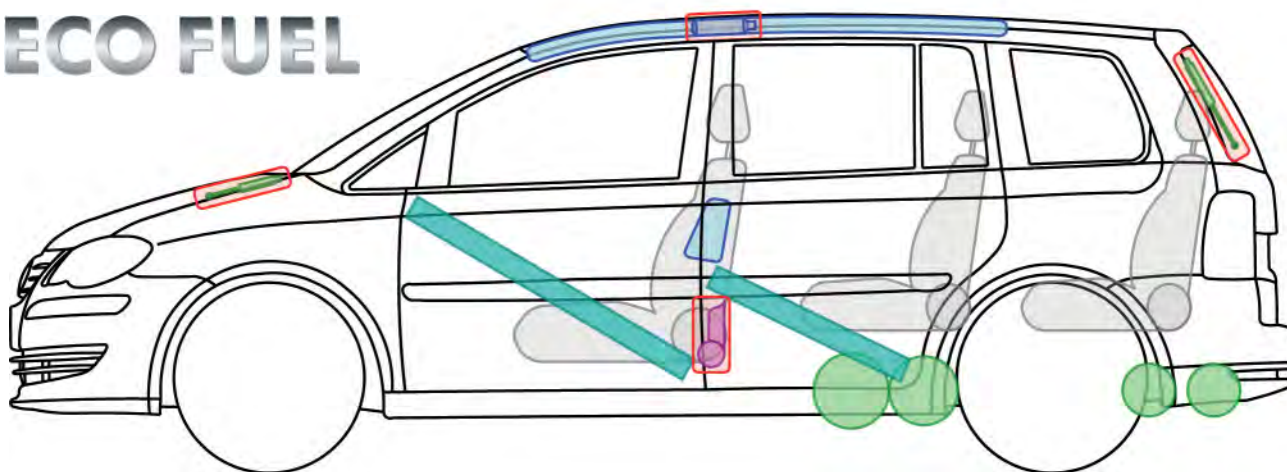



Erdgasantrieb

ECO FUEL

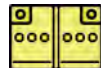

Legende

	Airbag		Karosserie-Verstärkung		Steuergerät		Gastank
	Gas-generator				12V-Batterie		Sicherheits-ventil
	Gurtstraffer		Gasdruck-dämpfer		Kraftstoff-tank		



Hinweise zur Erdgasanlage

Gastanks manuell absperren (bei Gasgeruch bzw. Austritt von Erdgas)

1. Zugang zu den Erdgastanks

- Der Zugang zu den Tanks erfolgt vom Unterboden aus.
- Die Gastanks sind durch eine Kunststoffabdeckung verkleidet. Um an die Erdgastanks zu gelangen, muss diese Abdeckung mit geeigneten Mitteln entfernt werden, ohne die darunter liegenden Bauteile der Gasanlage zu beschädigen.



elektromagnetische Absperrventile an den Gastanks

2. Absperrhähne lokalisieren

- Jeder Gastank besitzt ein eigenes Flaschenventil mit einem manuellen Absperrhahn.
- Falls einsatzbedingt erforderlich muss jeder Gastank separat abgesperrt werden.

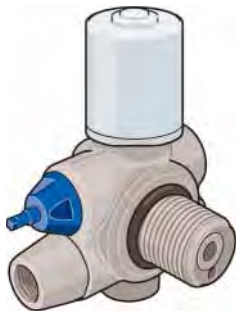

manueller Absperrhahn seitlich am Flaschenventil (bis 2008).

3. Gastank von Hand schließen

- Falls einsatzbedingt erforderlich muss jeder Gastank separat abgesperrt werden.
- Mit einem 5er-Maul- bzw. Ringschlüssel lässt sich das manuelle Absperrventil am Vierkant durch Drehen im Uhrzeigersinn bis zum Anschlag des Ventils verschließen.



manueller Absperrhahn am Fuß des Flaschenventils.

T

Touran (EcoFuel, ab 2006)







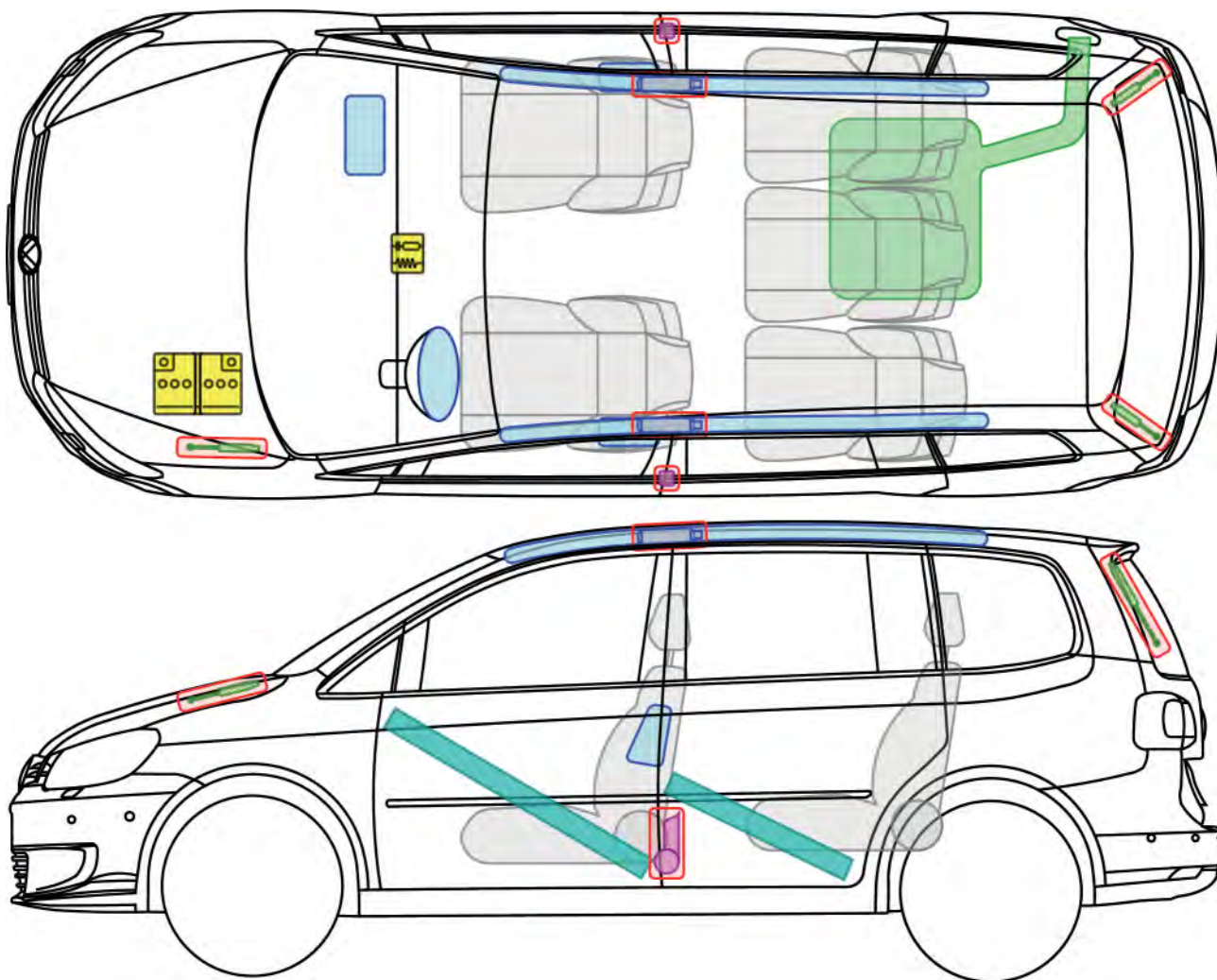



Touran

(5-Sitzer, ab 2010)



Legende

	Airbag		Karosserie-Verstärkung		Steuergerät
	Gas-generator				12V-Batterie
	Gurtstraffer		Gasdruck-dämpfer		Kraftstoff-tank







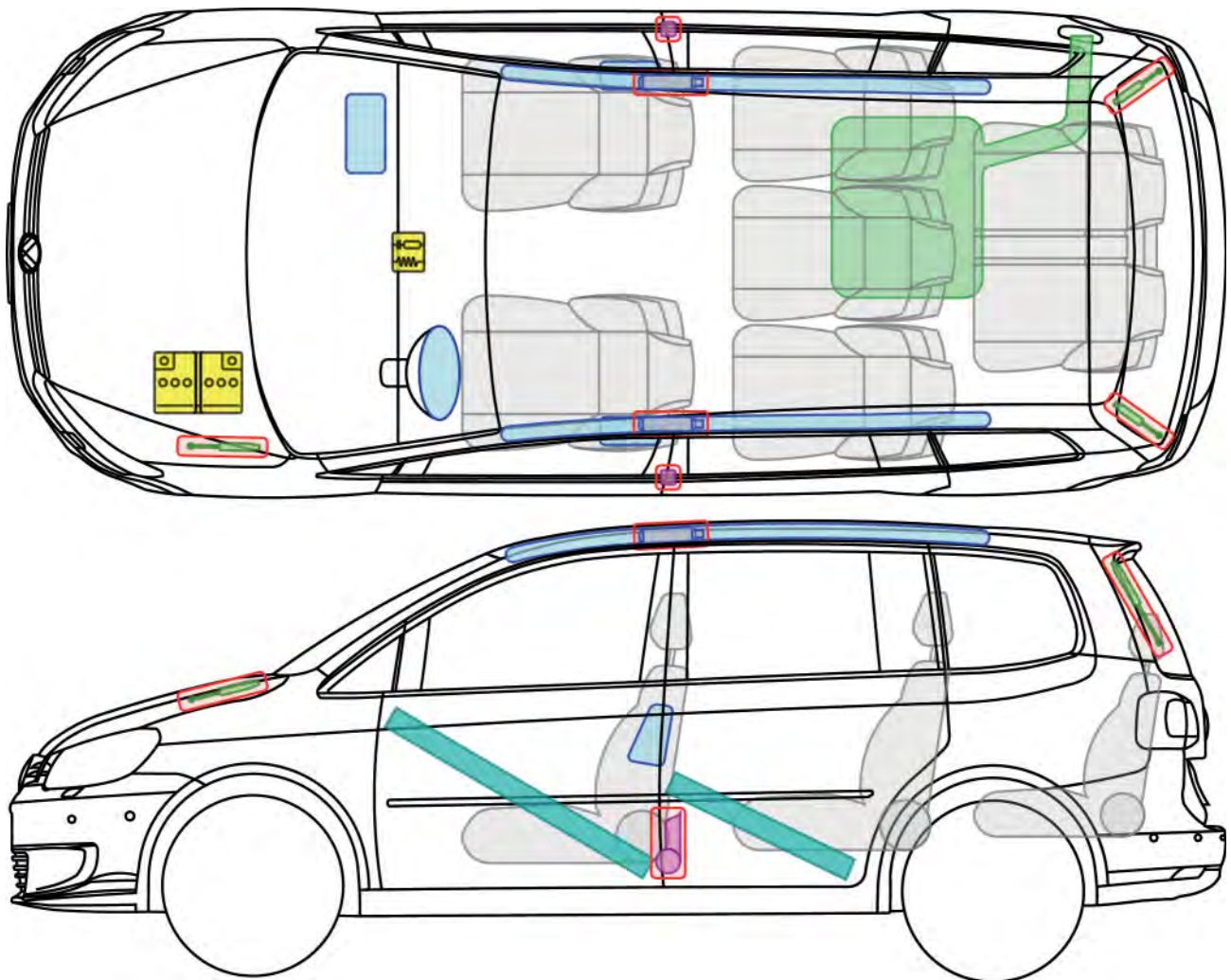



Touran

(7-Sitzer, ab 2010)



Legende

	Airbag		Karosserie-Verstärkung		Steuergerät
	Gas-generator				12V-Batterie
	Gurtstraffer		Gasdruck-dämpfer		Kraftstoff-tank



Touran

(5-Sitzer EcoFuel, ab 2010)

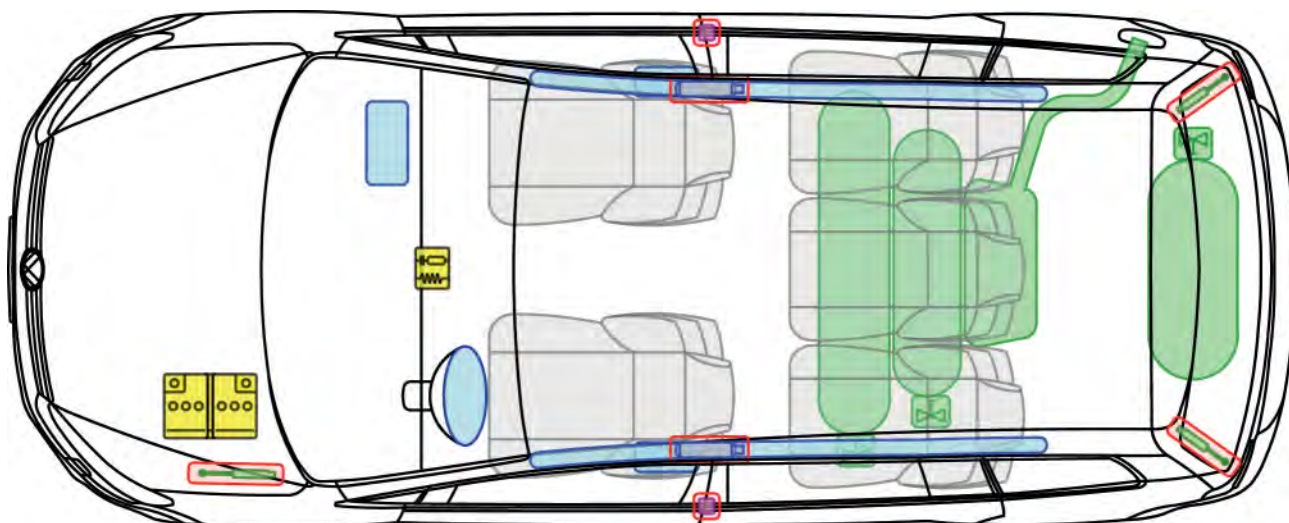





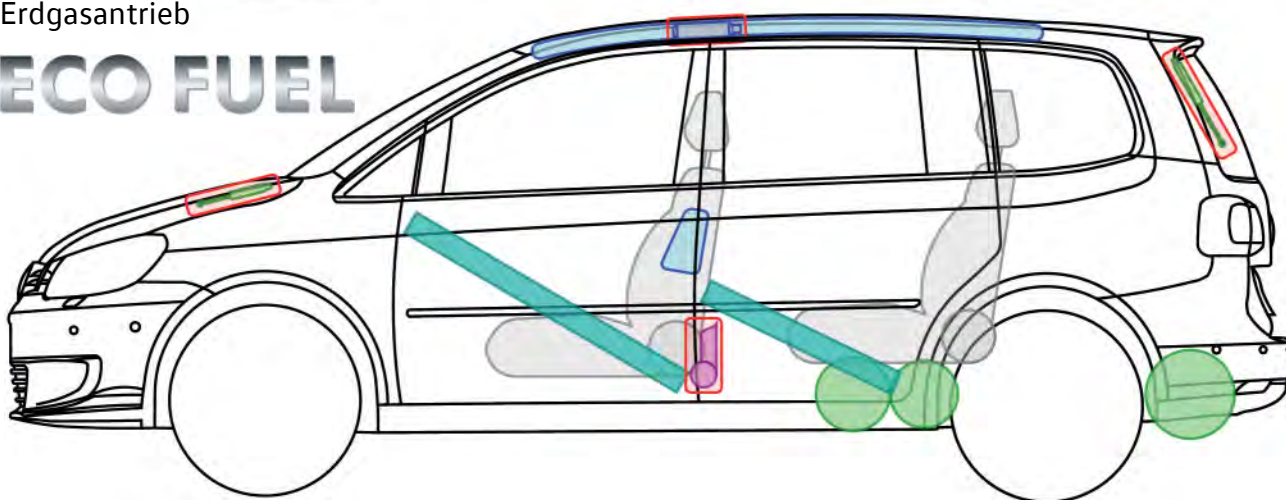





Erdgasantrieb

ECO FUEL

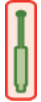

Legende

	Airbag		Karosserie-Verstärkung		Steuergerät		Gastank
	Gas-generator				12V-Batterie		Sicherheits-ventil
	Gurtstraffer		Gasdruck-dämpfer		Kraftstoff-tank		



Touran

(5-Sitzer EcoFuel, ab 2010)



Hinweise zur Erdgasanlage

Gastanks manuell absperren (bei Gasgeruch bzw. Austritt von Erdgas)

1. Zugang zu den Erdgastanks

- Der Zugang zu den Tanks erfolgt vom Unterboden aus.
- Die Gastanks sind durch eine Kunststoffabdeckung verkleidet. Um an die Erdgastanks zu gelangen, muss diese Abdeckung mit geeigneten Mitteln entfernt werden, ohne die darunter liegenden Bauteile der Gasanlage zu beschädigen.



elektromagnetische Absperrventile an den Gastanks

2. Absperrhähne lokalisieren

- Jeder Gastank besitzt ein eigenes Flaschenventil mit einem manuellen Absperrhahn.
- Falls einsatzbedingt erforderlich muss jeder Gastank separat abgesperrt werden.

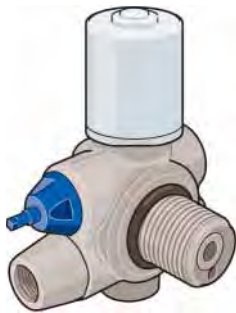

manueller Absperrhahn seitlich am Flaschenventil (bis 2008).

3. Gastank von Hand schließen

- Falls einsatzbedingt erforderlich muss jeder Gastank separat abgesperrt werden.
- Mit einem 5er-Maul- bzw. Ringschlüssel lässt sich das manuelle Absperrventil am Vierkant durch Drehen im Uhrzeigersinn bis zum Anschlag des Ventils verschließen.



manueller Absperrhahn am Fuß des Flaschenventils.

T

Touran (5-Sitzer EcoFuel, ab 2010)



Touran

(7-Sitzer EcoFuel, ab 2010)

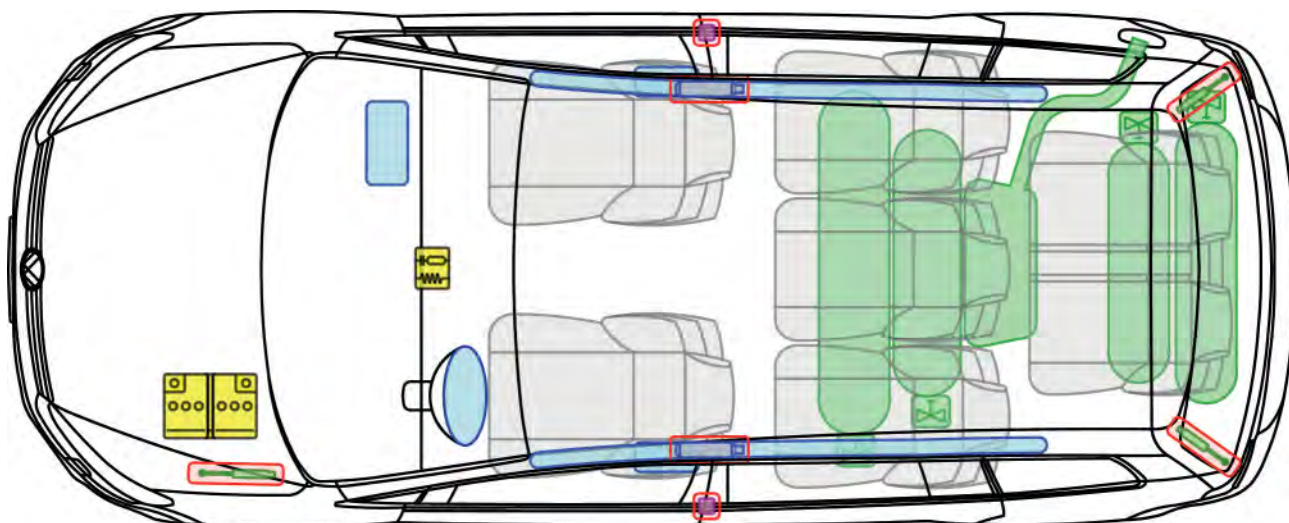





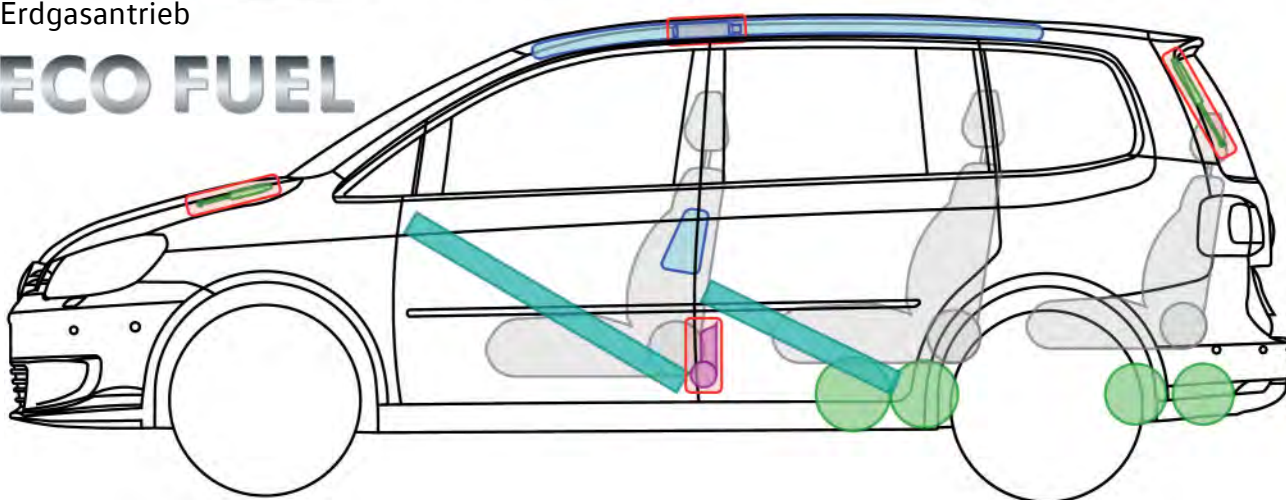





Erdgasantrieb

ECO FUEL



Legende

	Airbag		Karosserie-Verstärkung		Steuergerät		Gastank
	Gas-generator				12V-Batterie		Sicherheits-ventil
	Gurtstraffer		Gasdruck-dämpfer		Kraftstoff-tank		



Touran

(7-Sitzer EcoFuel, ab 2010)



Hinweise zur Erdgasanlage

Gastanks manuell absperren (bei Gasgeruch bzw. Austritt von Erdgas)

1. Zugang zu den Erdgastanks

- Der Zugang zu den Tanks erfolgt vom Unterboden aus.
- Die Gastanks sind durch eine Kunststoffabdeckung verkleidet. Um an die Erdgastanks zu gelangen, muss diese Abdeckung mit geeigneten Mitteln entfernt werden, ohne die darunter liegenden Bauteile der Gasanlage zu beschädigen.



elektromagnetische Absperrventile an den Gastanks

2. Absperrhähne lokalisieren

- Jeder Gastank besitzt ein eigenes Flaschenventil mit einem manuellen Absperrhahn.
- Falls einsatzbedingt erforderlich muss jeder Gastank separat abgesperrt werden.

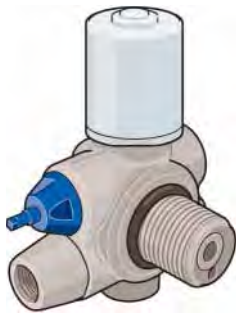

manueller Absperrhahn seitlich am Flaschenventil (bis 2008).

3. Gastank von Hand schließen

- Falls einsatzbedingt erforderlich muss jeder Gastank separat abgesperrt werden.
- Mit einem 5er-Maul- bzw. Ringschlüssel lässt sich das manuelle Absperrventil am Vierkant durch Drehen im Uhrzeigersinn bis zum Anschlag des Ventils verschließen.



manueller Absperrhahn am Fuß des Flaschenventils.

T

Touran (7-Sitzer EcoFuel, ab 2010)







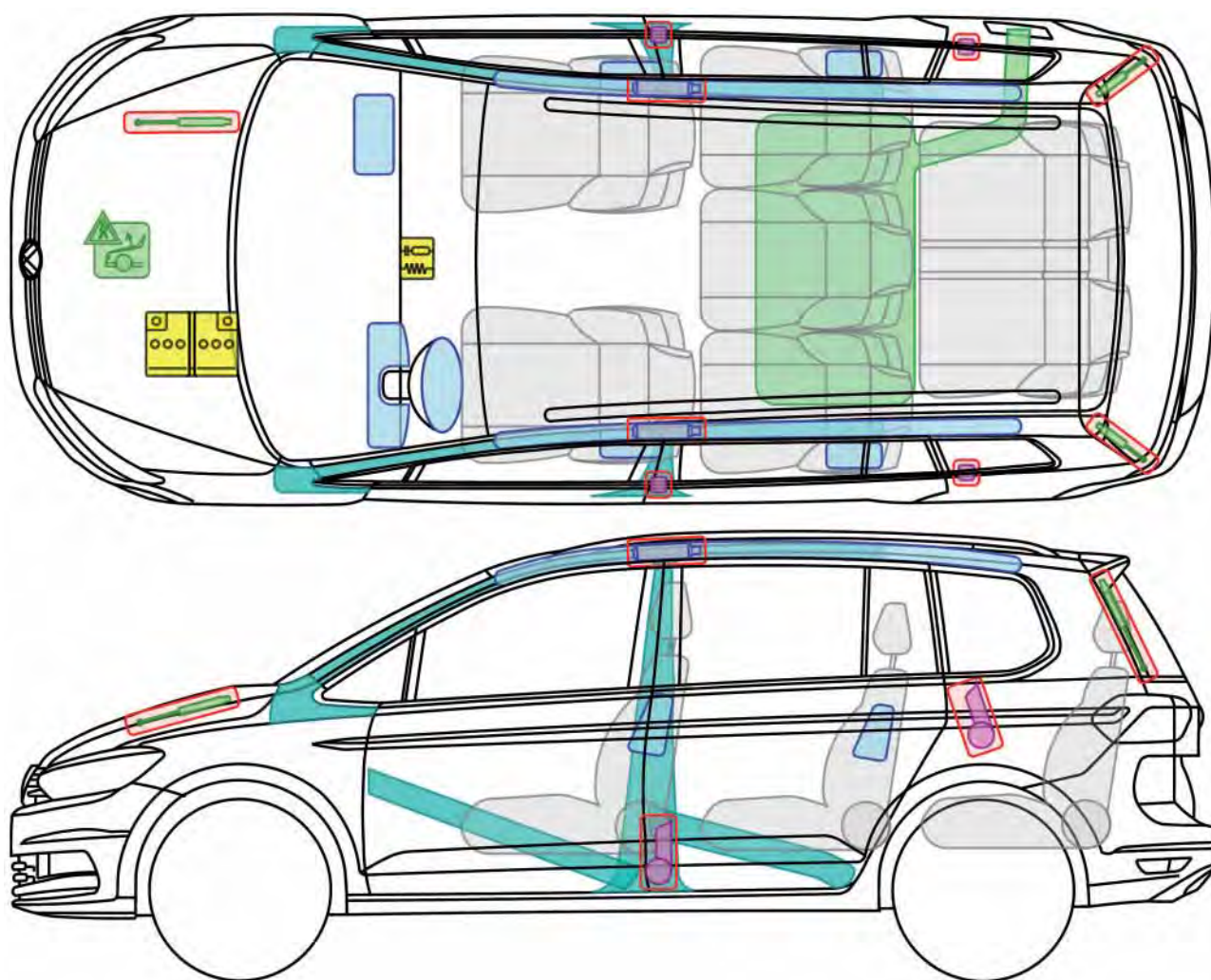



Touran

(7-Sitzer, ab 2015)



Der Touran 5-Sitzer und der Touran 7-Sitzer gleichen sich in den konstruktiven Maßnahmen zum Insassenschutz.

Legende

	Airbag		Karosserie-Verstärkung		Steuergerät		
	Gas-generator				12V-Batterie		
	Gurtstraffer		Gasdruck-dämpfer		Kraftstoff-tank		aktive Frontklappe





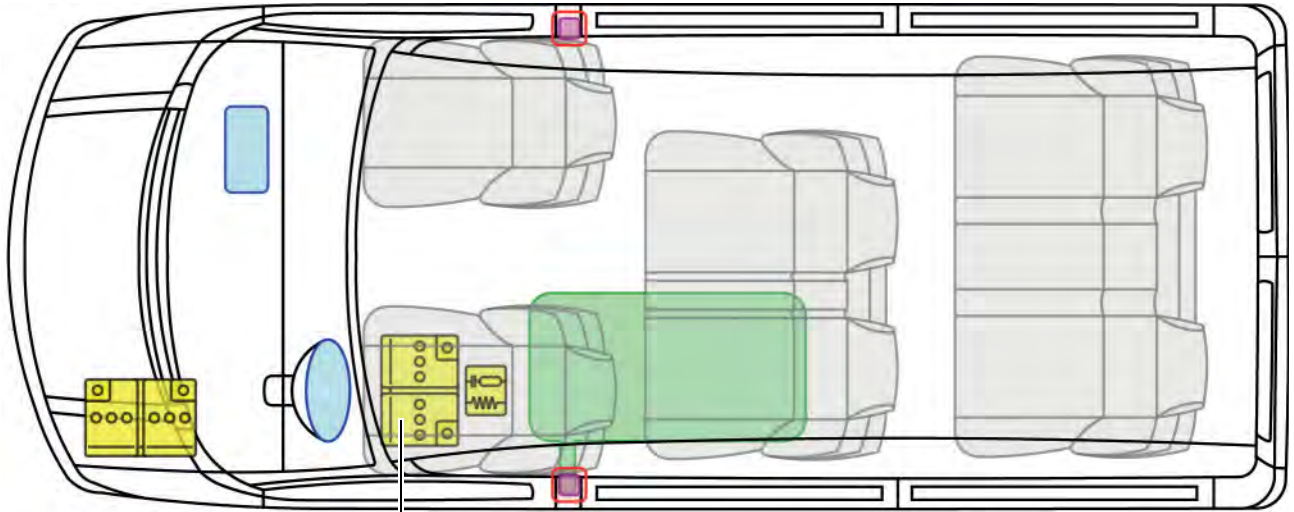

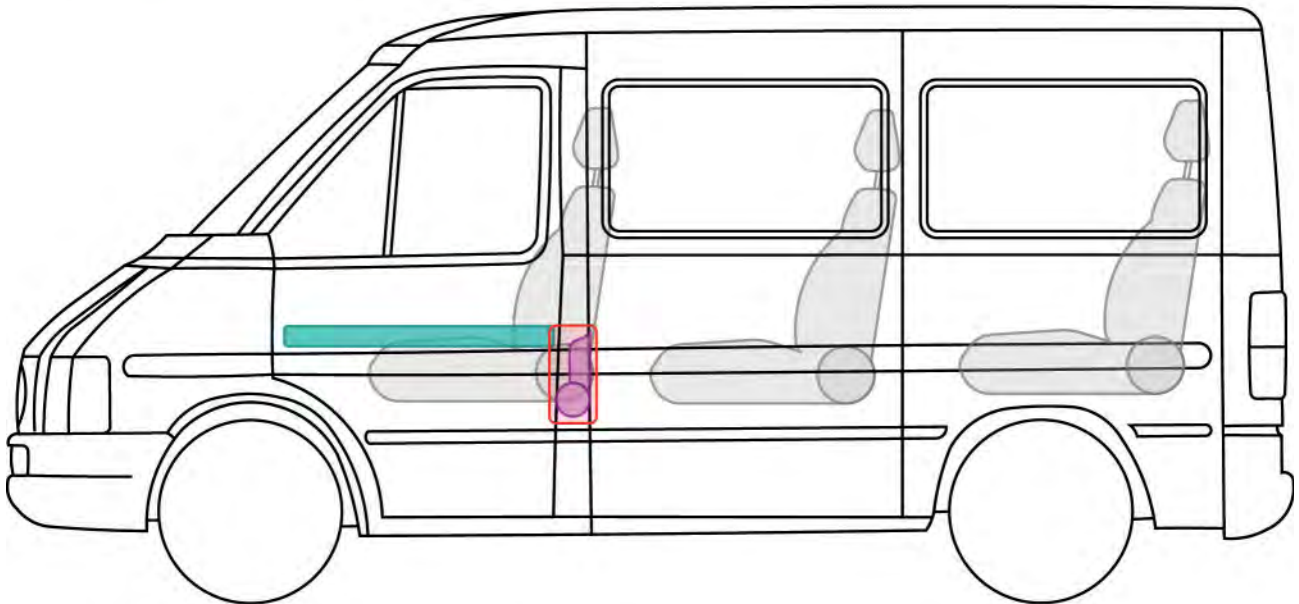

Transporter LT2 (ab 1996)



ausstattungsabhängig zusätzliche Batterie unter dem Fahrersitz



Legende





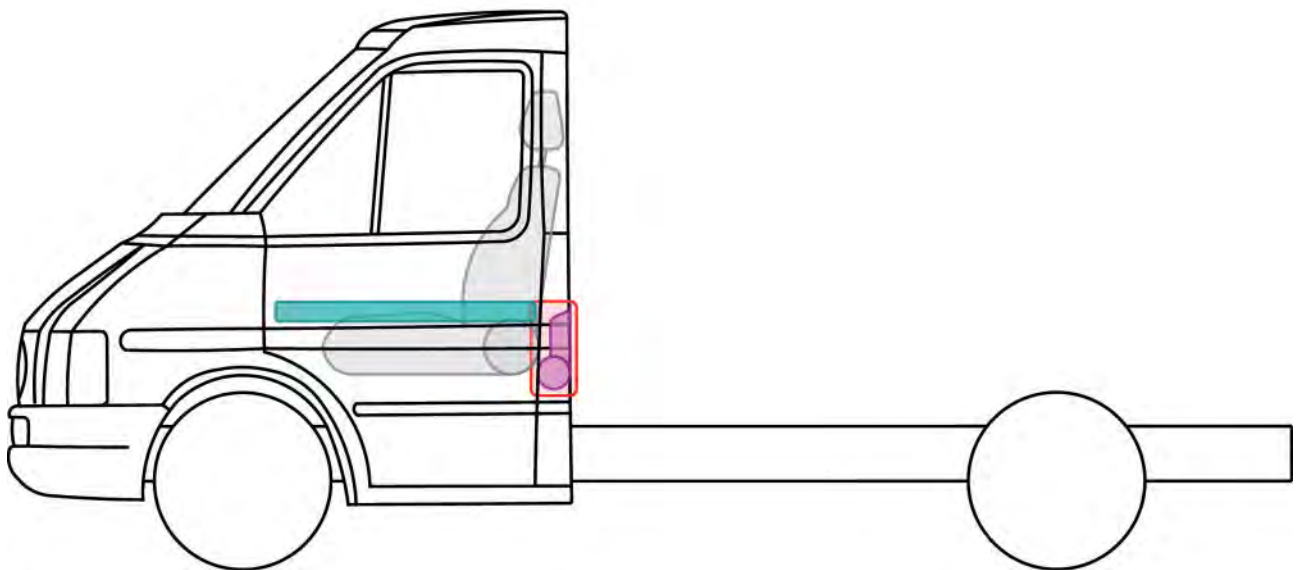
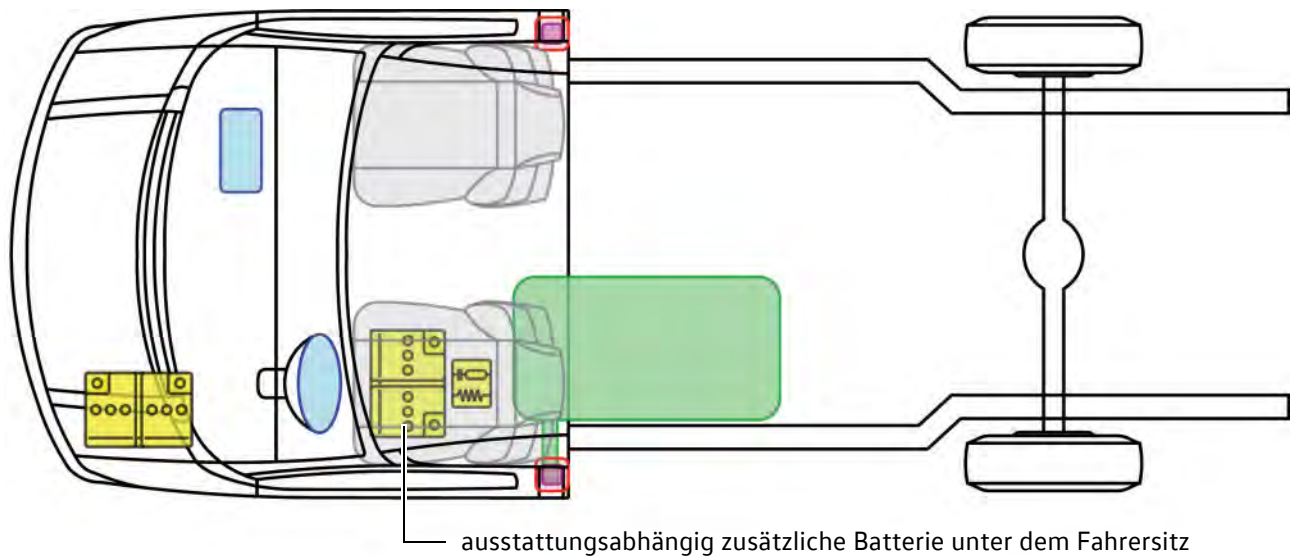

	Airbag		Karosserie-Verstärkung		Steuergerät	
					12V-Batterie	
	Gurtstraffer				Kraftstoff-tank	



Transporter LT2 Fahrgestell (2-Türer, ab 1996)



Legende

	Airbag		Karosserie-Verstärkung		Steuergerät	
					12V-Batterie	
	Gurtstraffer				Kraftstoff-tank	





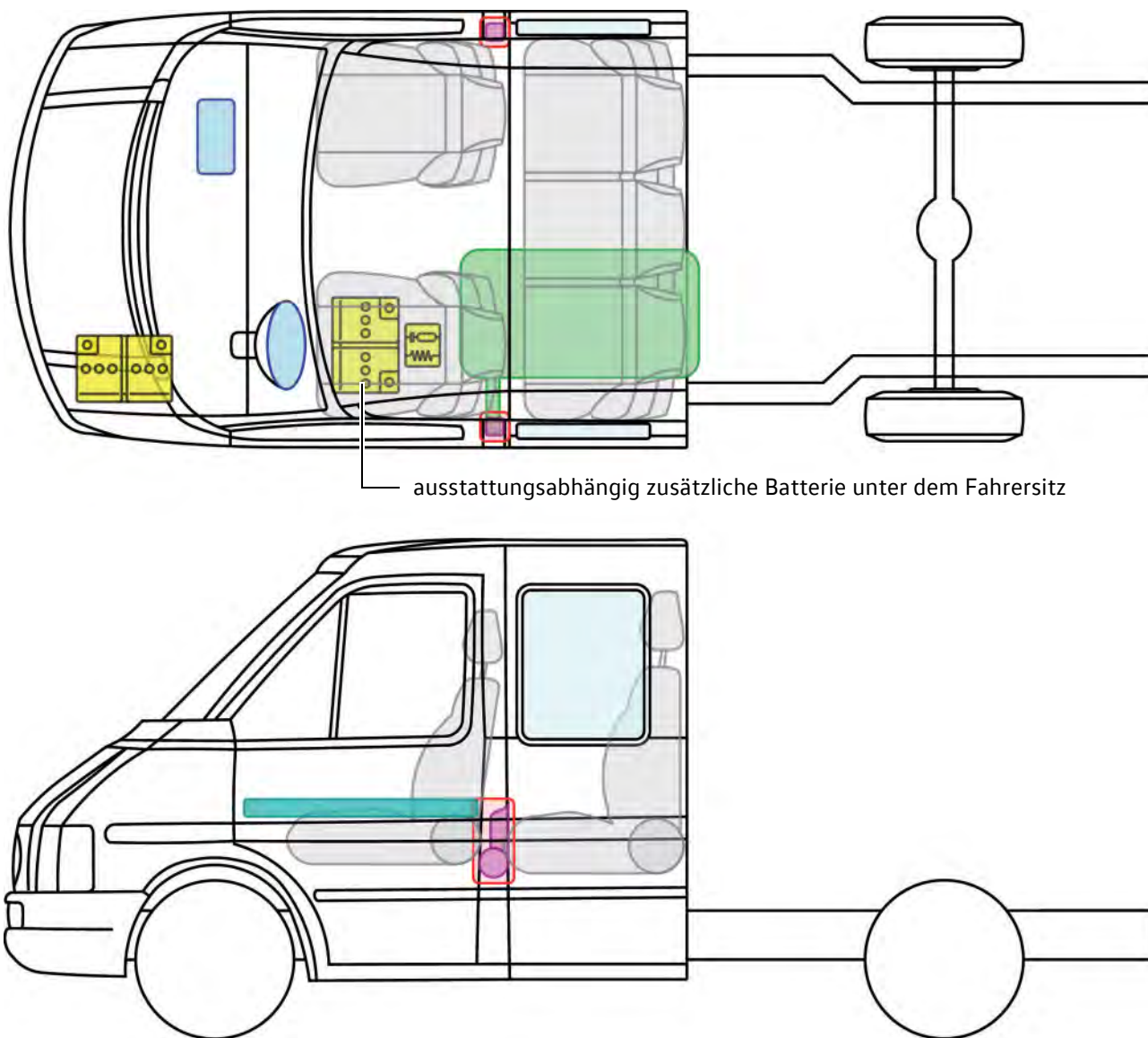



Transporter LT2 Fahrgestell (4-Türer, ab 1996)



ausstattungsabhängig zusätzliche Batterie unter dem Fahrersitz

Legende

	Airbag		Karosserie-Verstärkung		Steuergerät
					12V-Batterie
	Gurtstraffer				Kraftstoff-tank







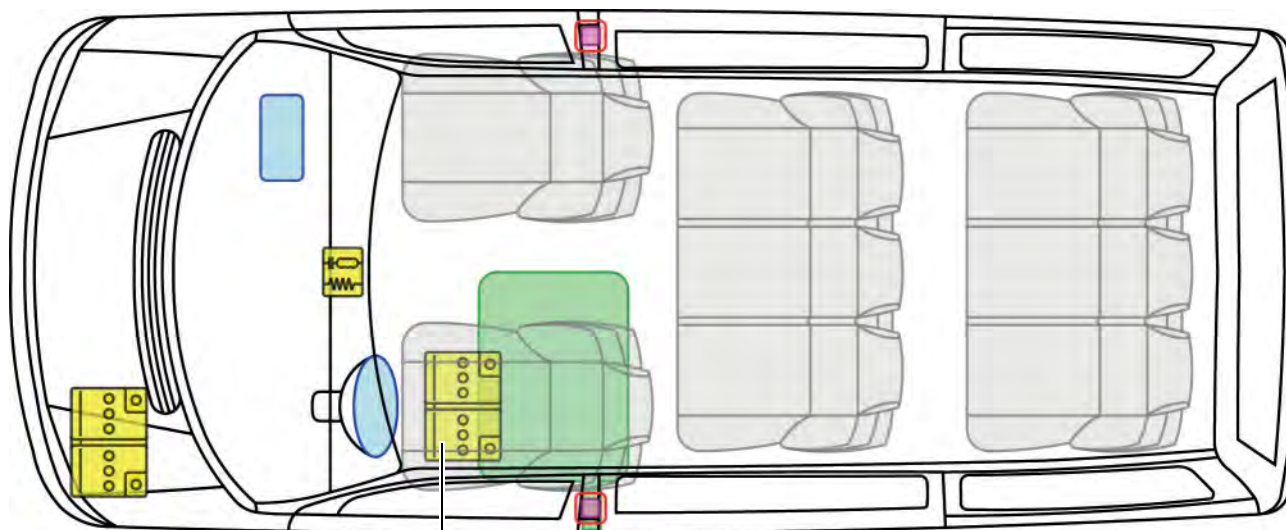

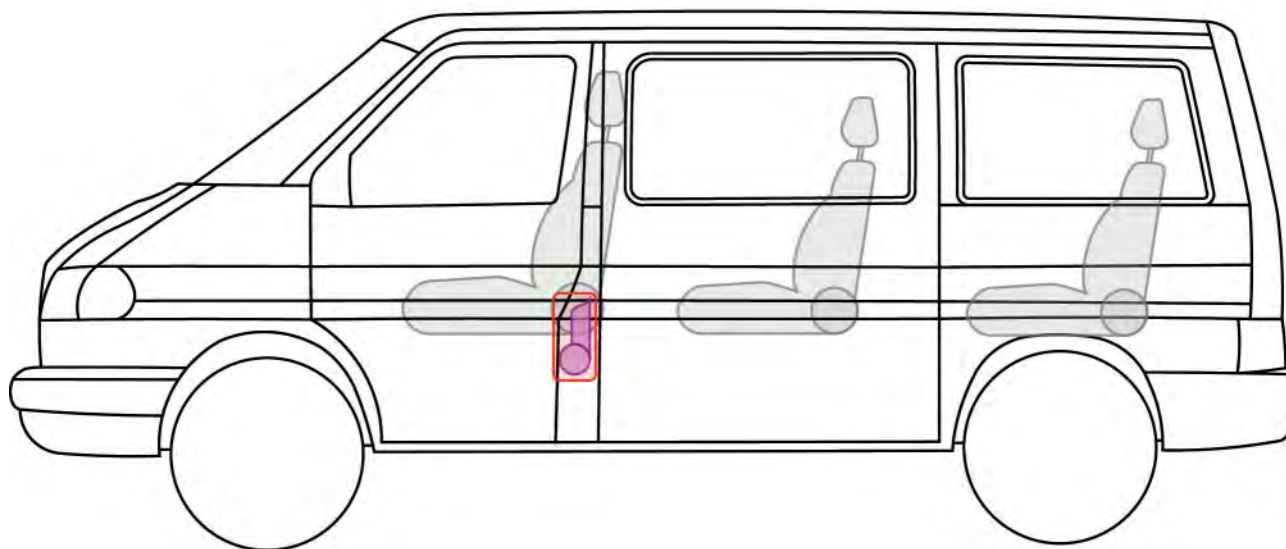

Transporter T4 (ab 1991)



ausstattungsabhängig zusätzliche Batterie unter dem Fahrersitz

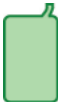

Legende

	Airbag		Karosserie-Verstärkung		Steuergerät
					12V-Batterie
	Gurtstraffer				Kraftstoff-tank





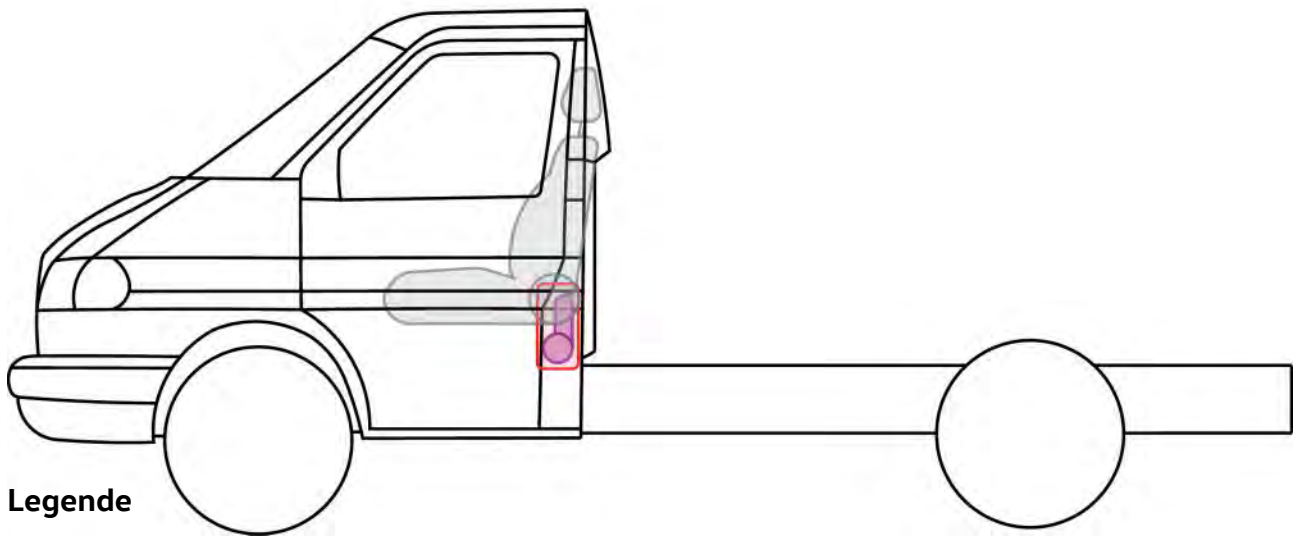
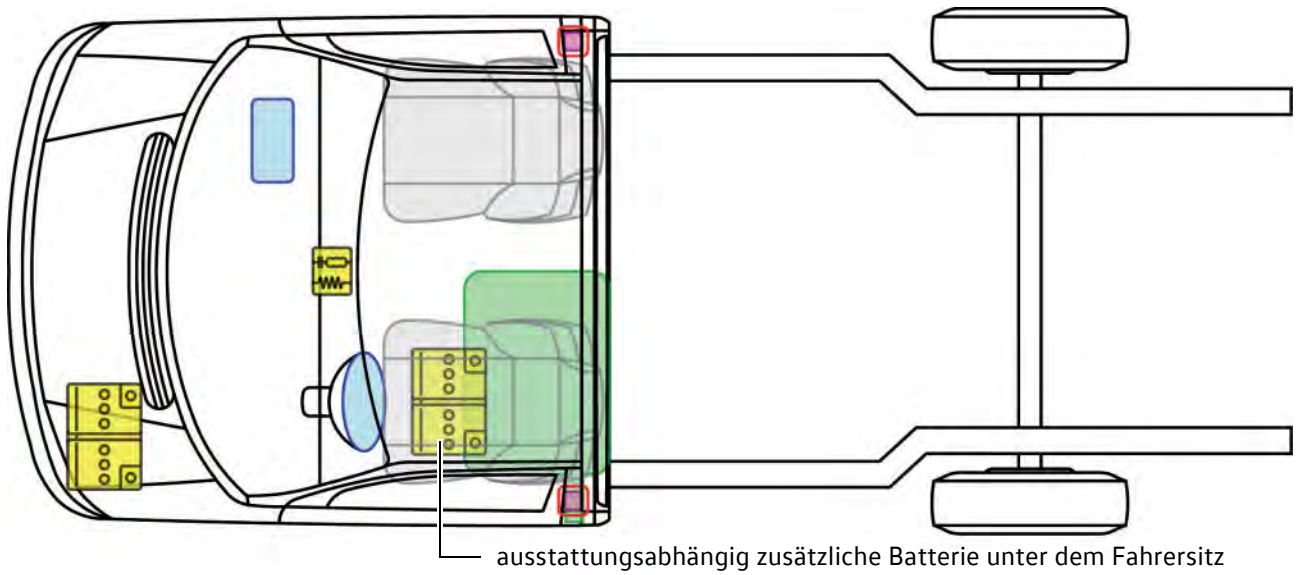

Transporter T4 Fahrgestell

(2-Türer, ab 1991)



Legende

	Airbag		Steuergerät
			12V-Batterie
	Gurtstraffer		Kraftstoff-tank



Transporter T4 Fahrgestell



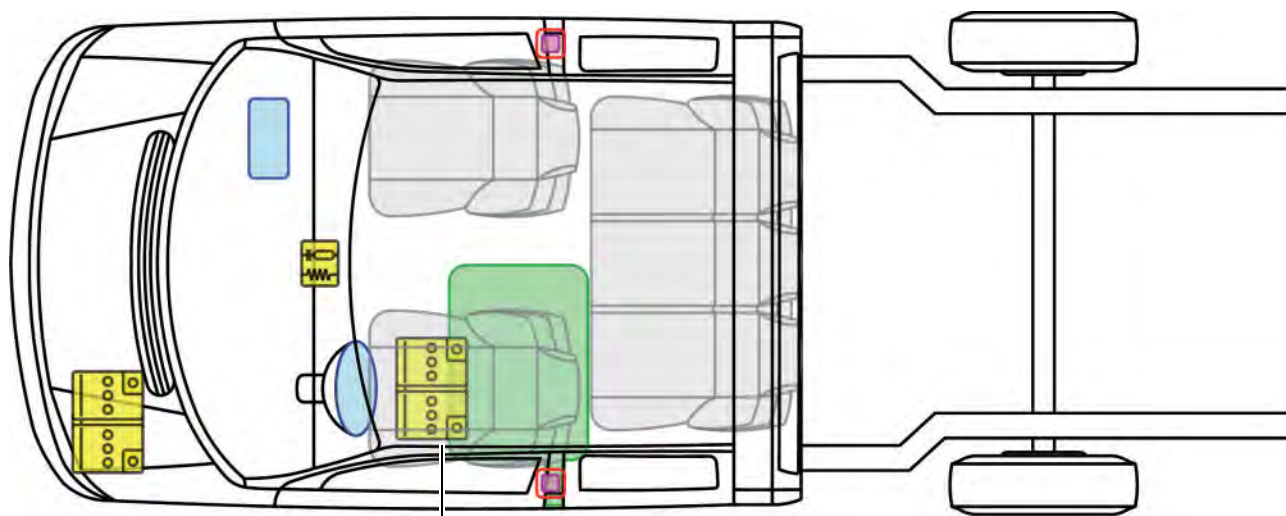

(4-Türer, ab 1991)

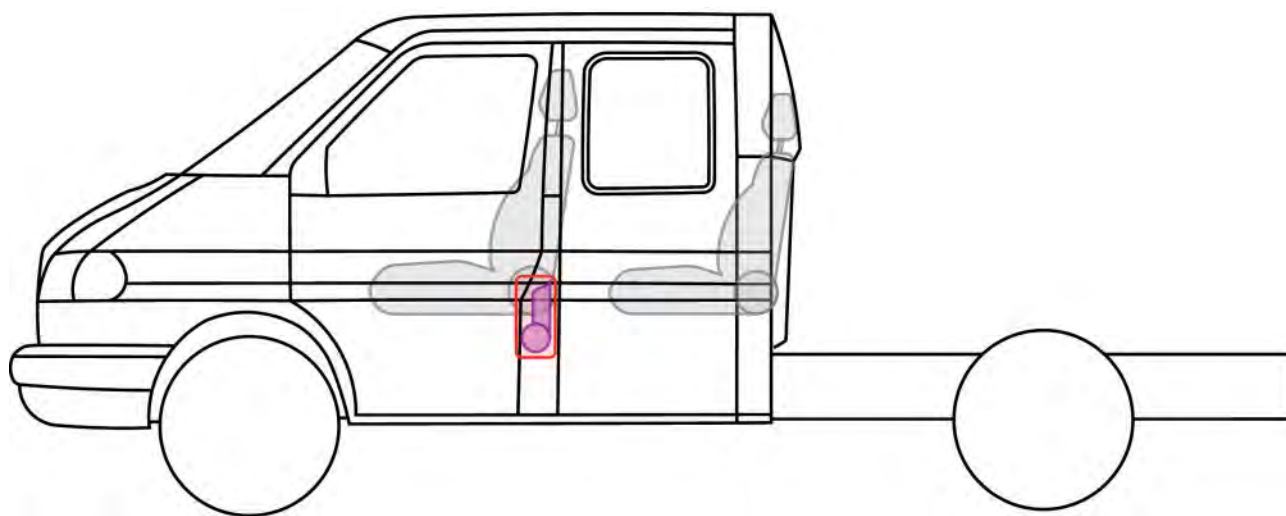

ausstattungsabhängig zusätzliche Batterie unter dem Fahrersitz

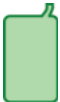

Legende

	Airbag		Steuergerät
			12V-Batterie
	Gurtstraffer		Kraftstoff-tank



Transporter T5



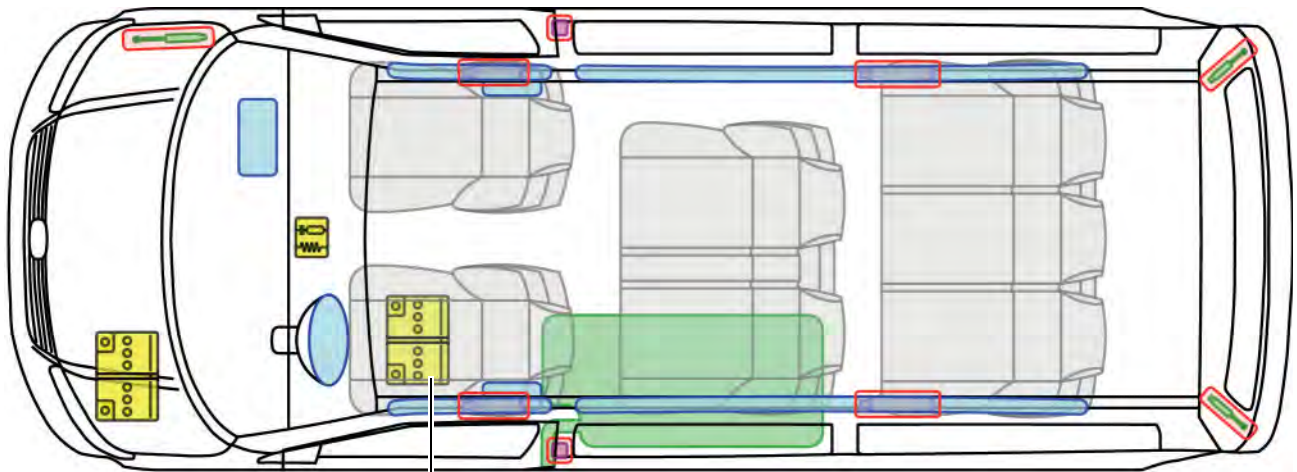



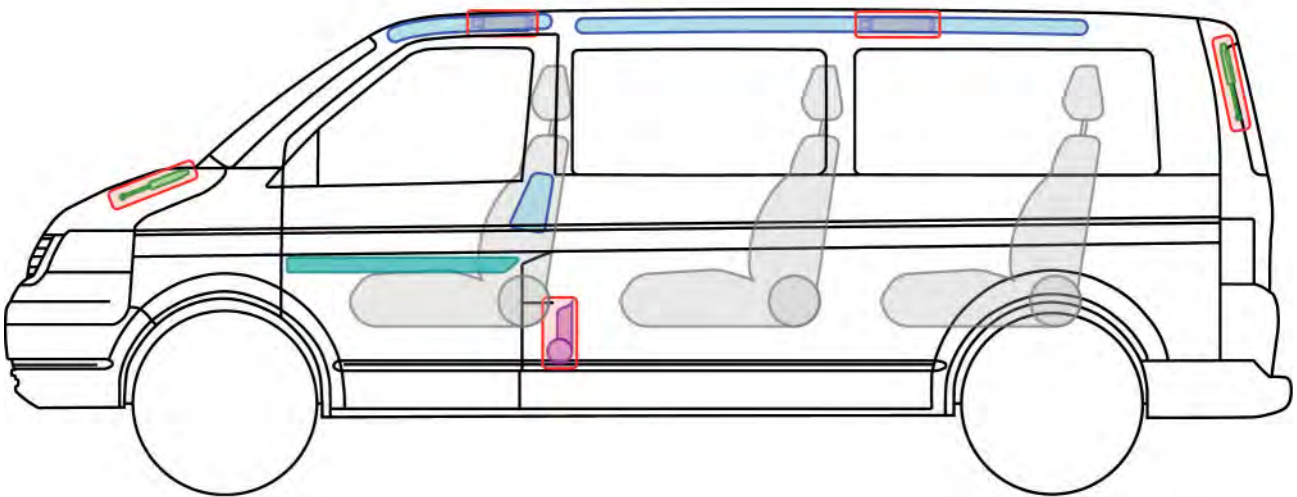

(ab 2003)



ausstattungsabhängig zusätzliche Batterie unter dem Fahrersitz



Legende

	Airbag		Karosserie-Verstärkung		Steuergerät
	Gas-generator				12V-Batterie
	Gurtstraffer		Gasdruck-dämpfer		Kraftstoff-tank

T

Transporter T5 (ab 2003)



Transporter T5 Fahrgestell



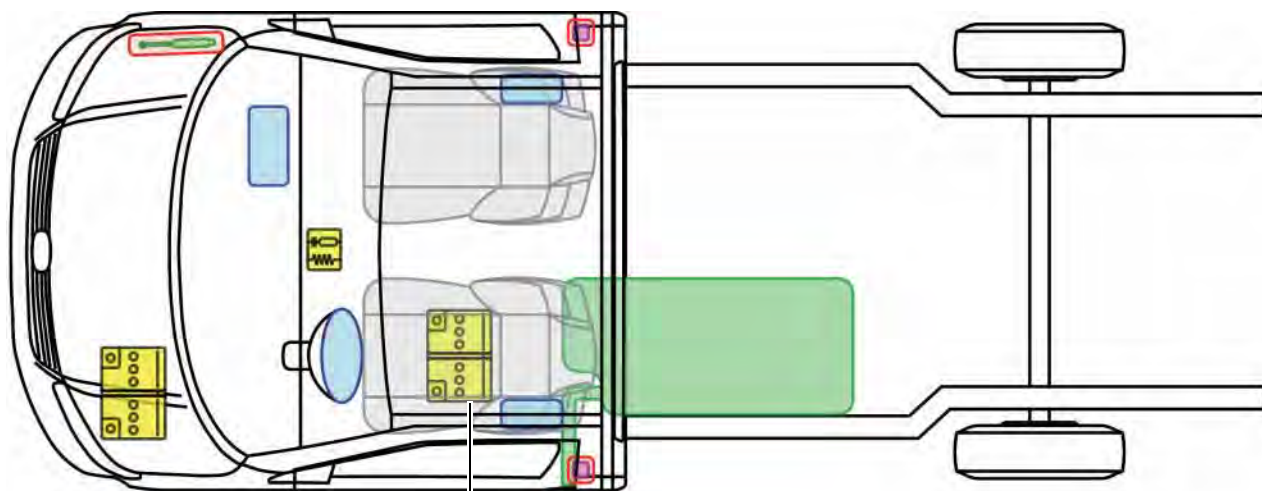

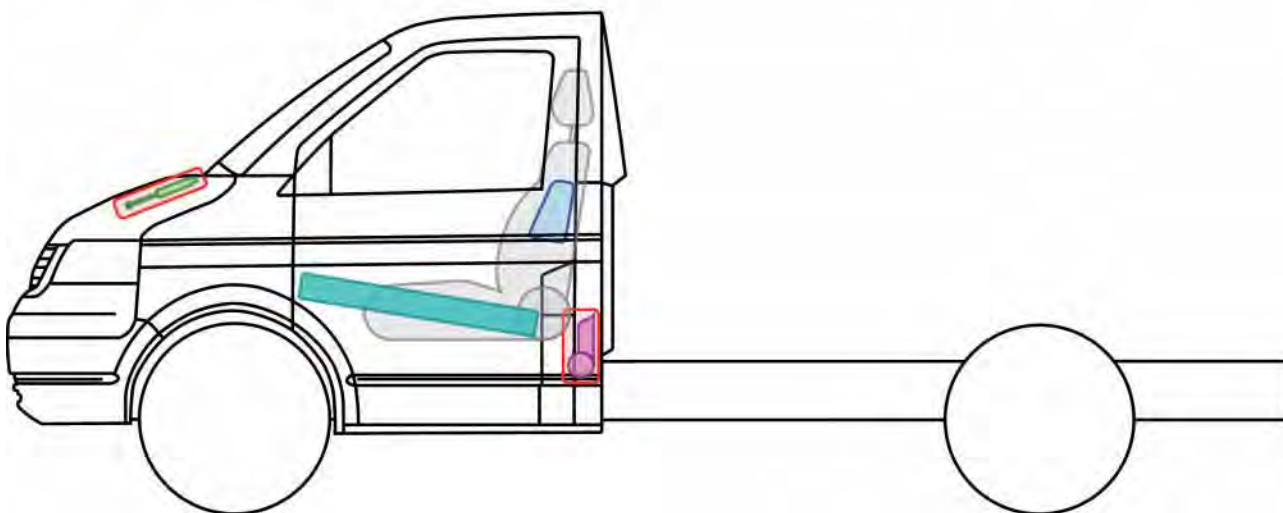

(2-Türer, ab 2003)



ausstattungsabhängig zusätzliche Batterie unter dem Fahrersitz



Legende

	Airbag		Karosserie-Verstärkung		Steuergerät
					12V-Batterie
	Gurtstraffer		Gasdruck-dämpfer		Kraftstoff-tank



Transporter T5 Fahrgestell



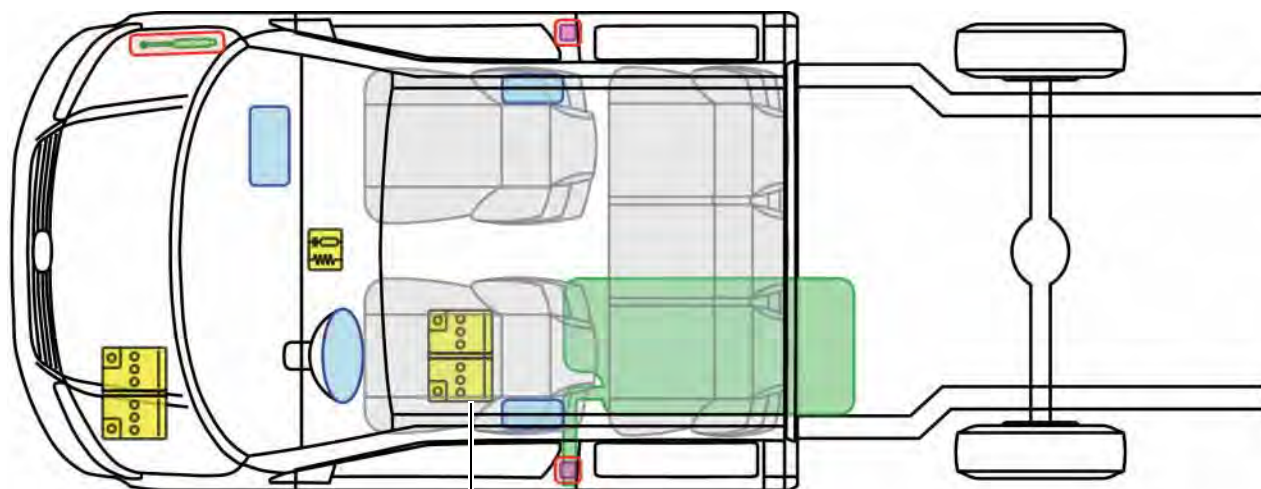

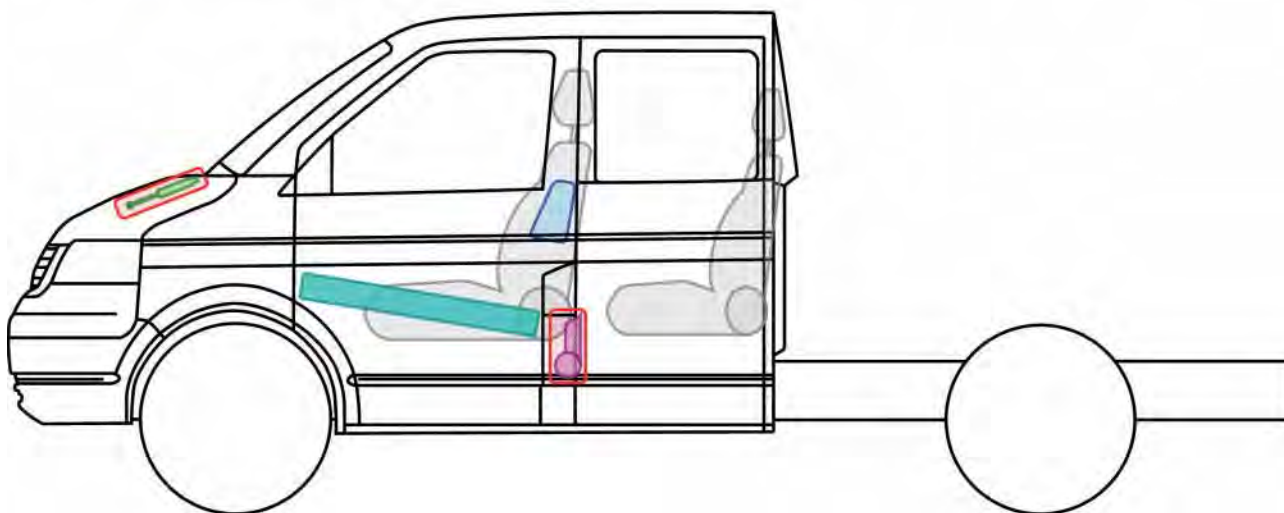

(4-Türer, ab 2003)



ausstattungsabhängig zusätzliche Batterie unter dem Fahrersitz



Legende

	Airbag		Karosserie-Verstärkung		Steuergerät	
					12V-Batterie	
	Gurtstraffer		Gasdruck-dämpfer		Kraftstoff-tank	







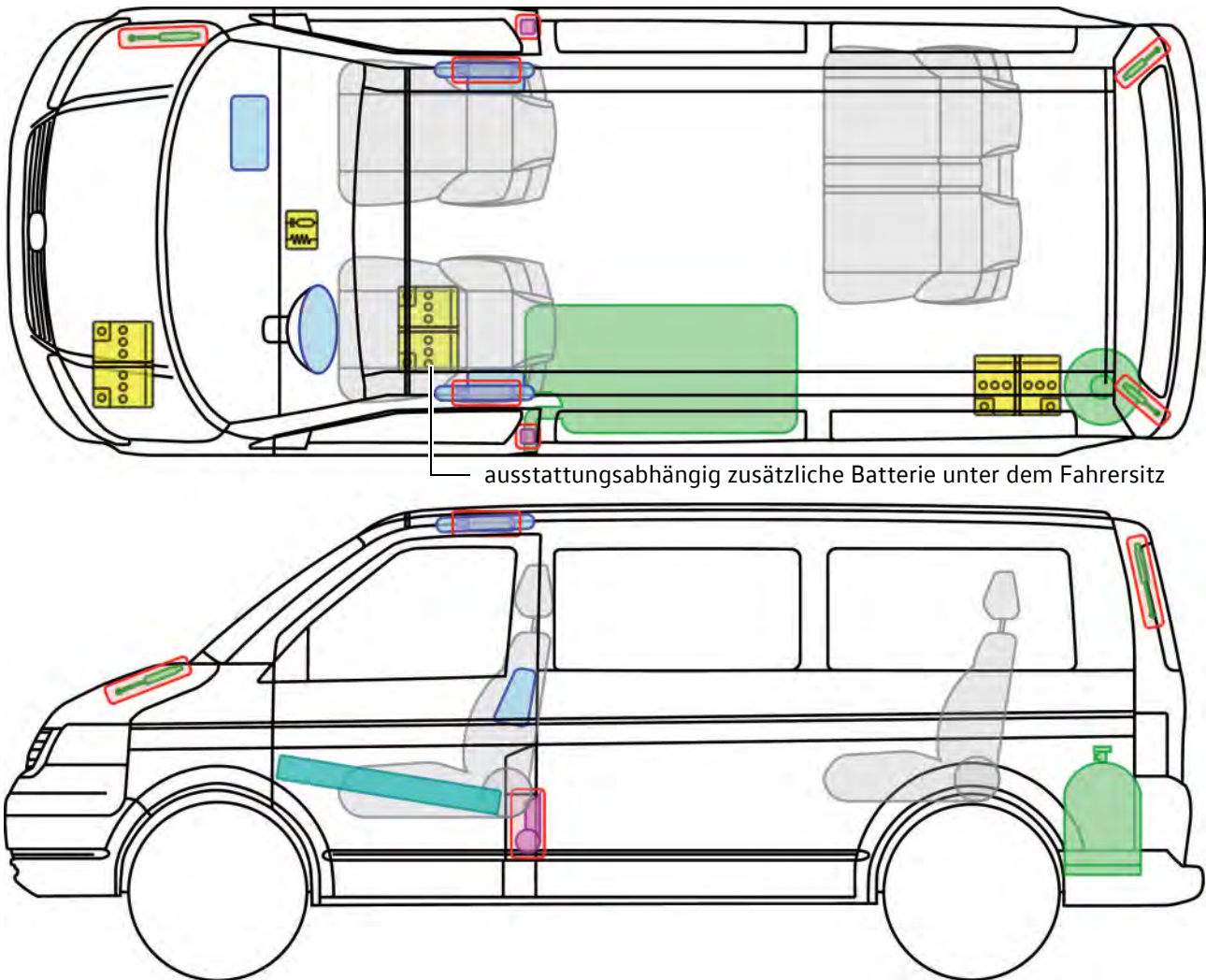



Transporter T5 California

(ab 2003)

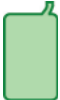

Legende

	Airbag		Karosserie-Verstärkung		Steuergerät		Gastank
	Gas-generator				12V-Batterie		
	Gurtstraffer		Gasdruck-dämpfer		Kraftstoff-tank		





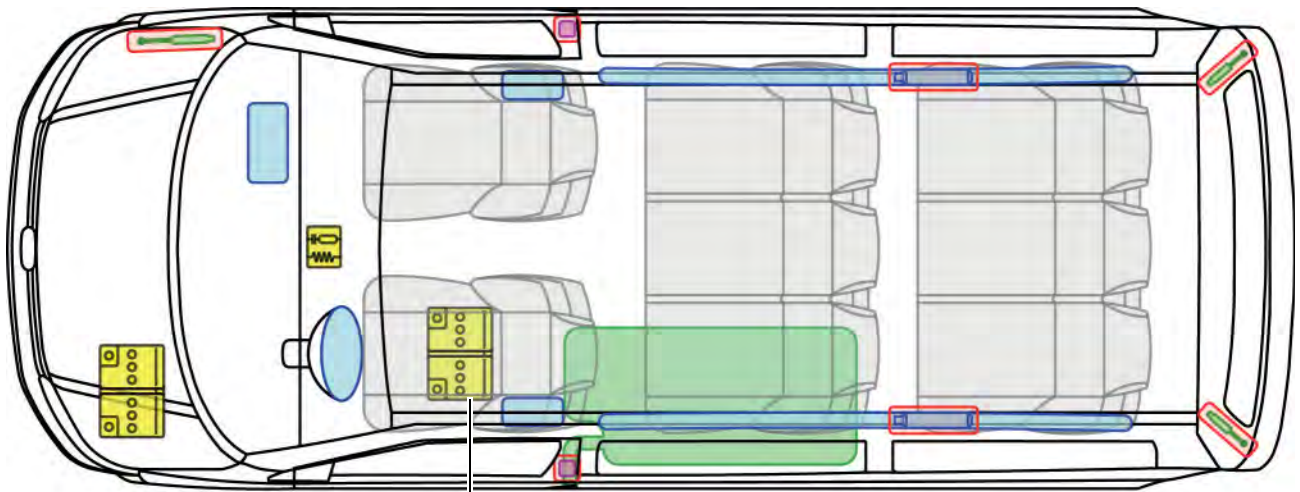



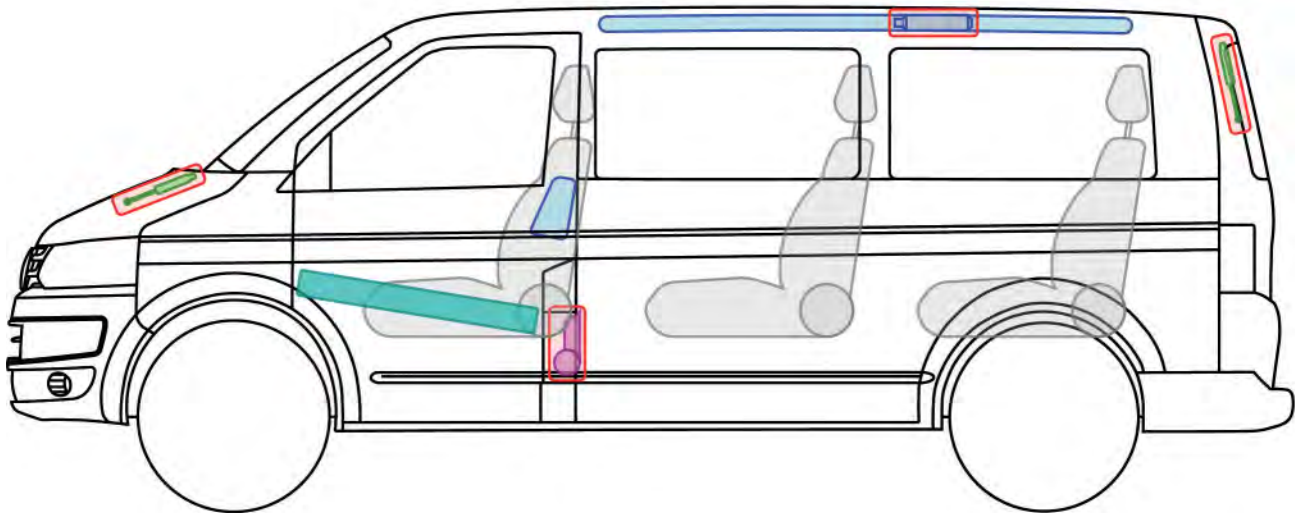

Transporter T5 (ab 2010)



ausstattungsabhängig zusätzliche Batterie unter dem Fahrersitz

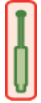

Legende

	Airbag		Karosserie-Verstärkung		Steuergerät
	Gas-generator				12V-Batterie
	Gurtstraffer		Gasdruck-dämpfer		Kraftstoff-tank







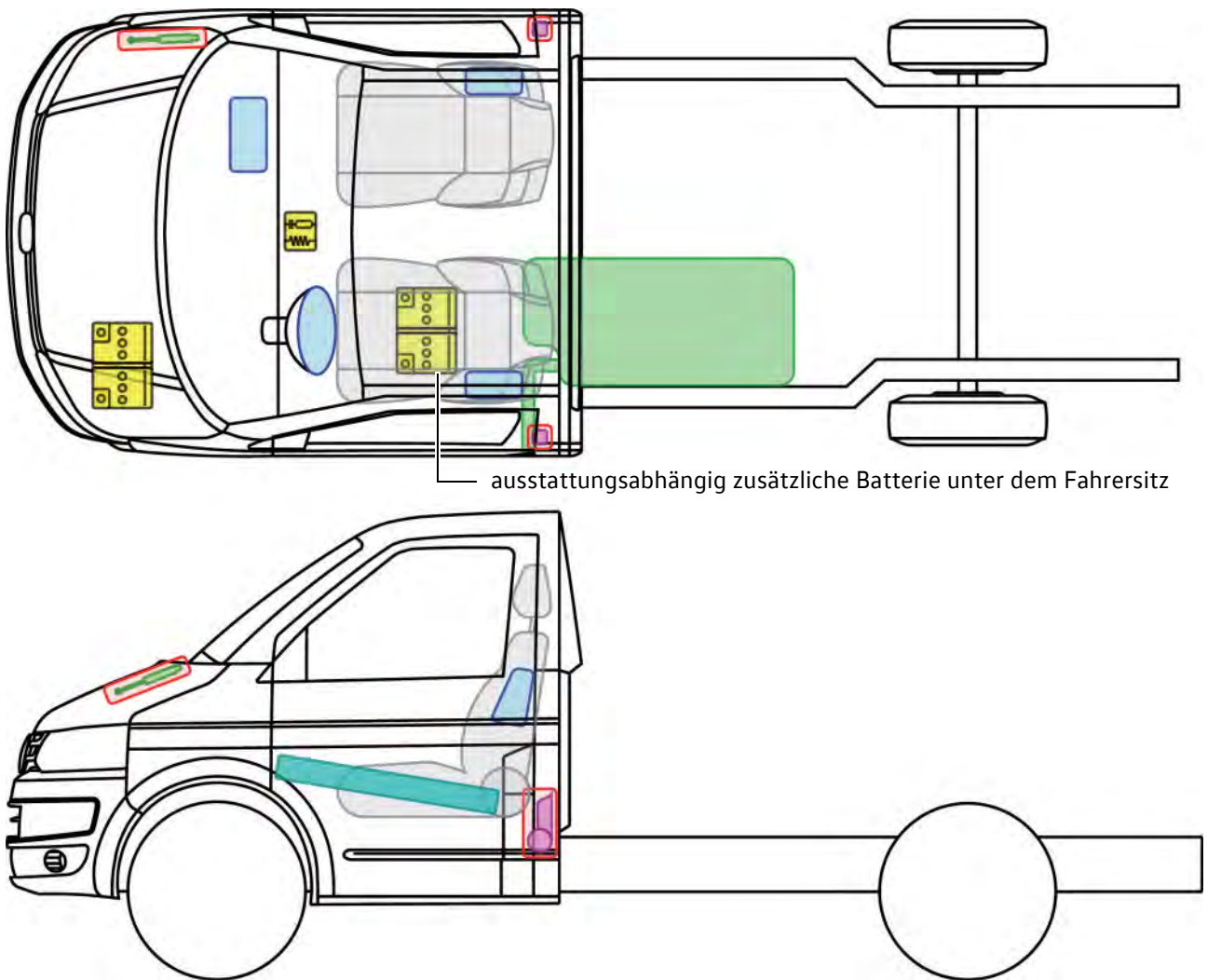

Transporter T5 Fahrgestell

(2-Türer, ab 2010)



Legende

	Airbag		Karosserie-Verstärkung		Steuergerät
					12V-Batterie
	Gurtstraffer		Gasdruck-dämpfer		Kraftstoff-tank



Transporter T5 Fahrgestell



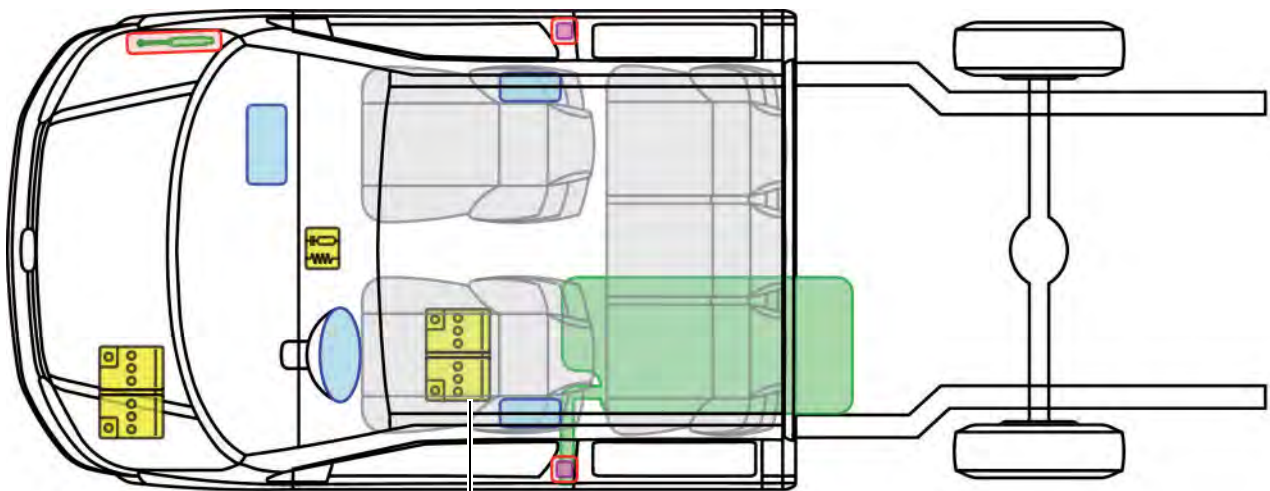

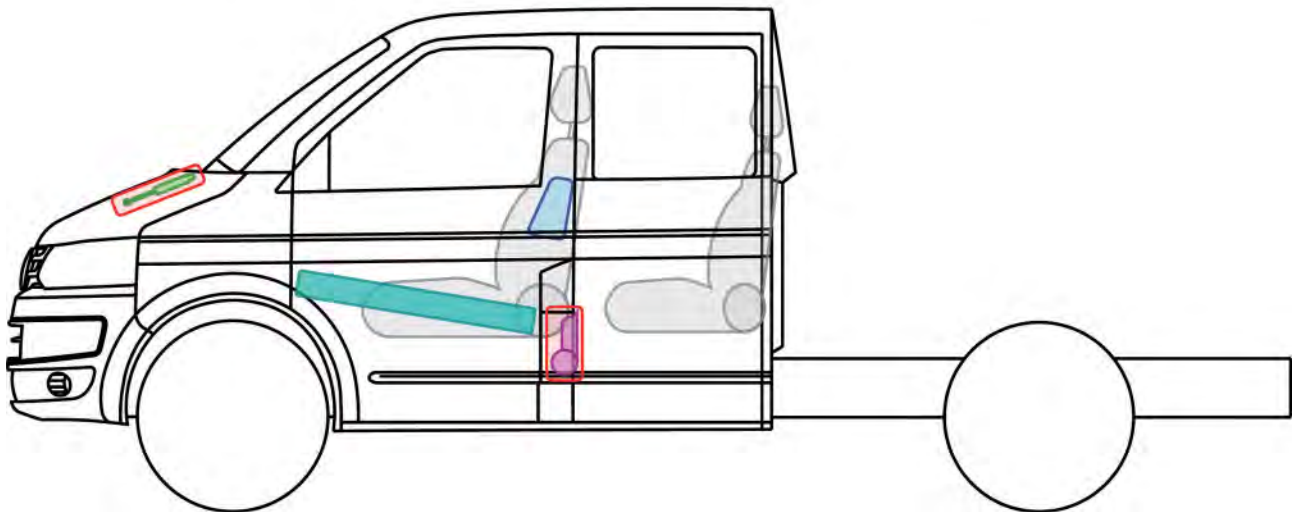

(4-Türer, ab 2010)



ausstattungsabhängig zusätzliche Batterie unter dem Fahrersitz

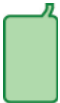

Legende

	Airbag		Karosserie-Verstärkung		Steuergerät
					12V-Batterie
	Gurtstraffer		Gasdruckdämpfer		Kraftstoff-tank







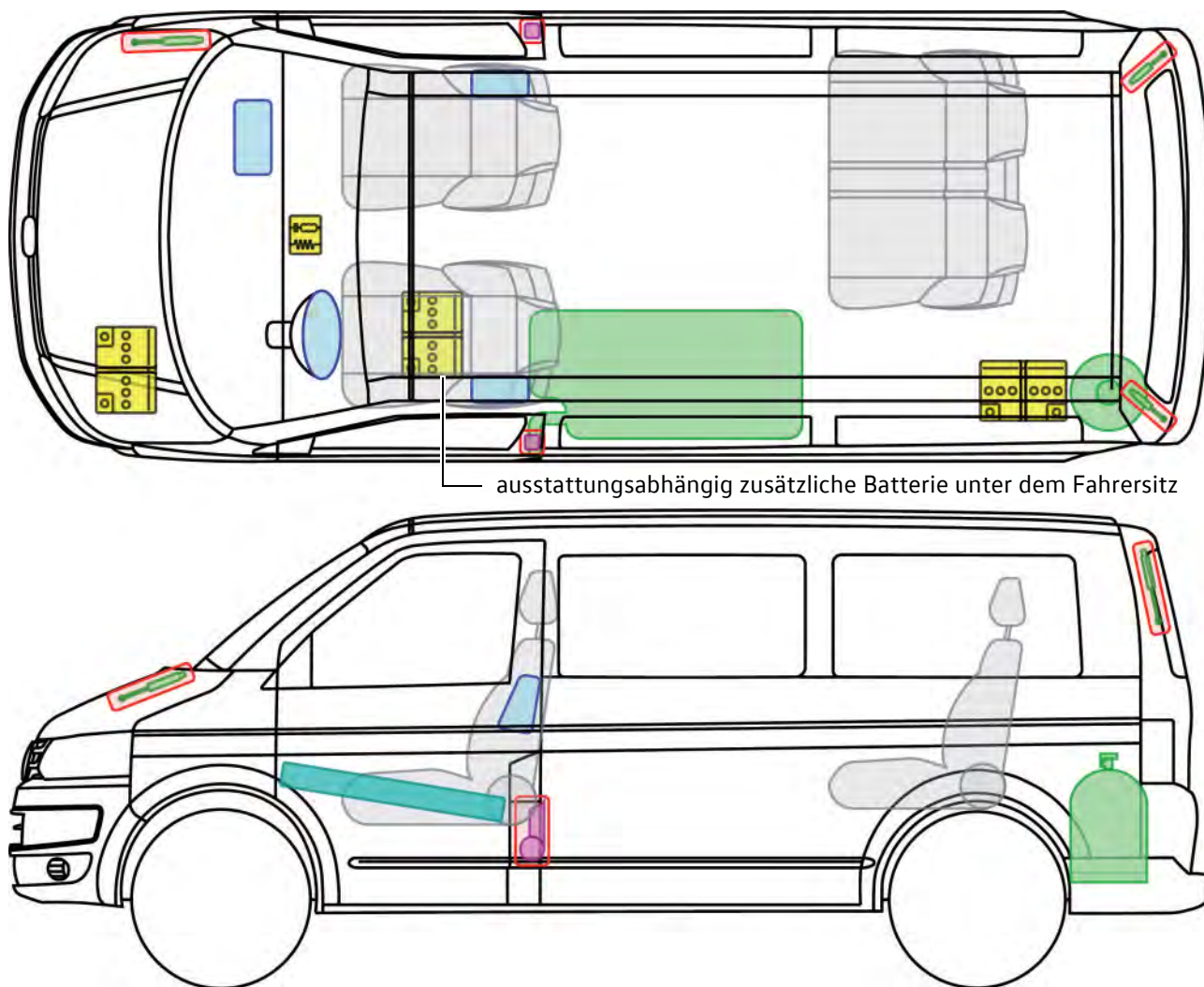

Transporter T5 California

(ab 2010)

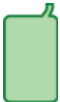

Legende

	Airbag		Karosserie-Verstärkung		Steuergerät		Gastank
					12V-Batterie		
	Gurtstraffer		Gasdruck-dämpfer		Kraftstoff-tank		







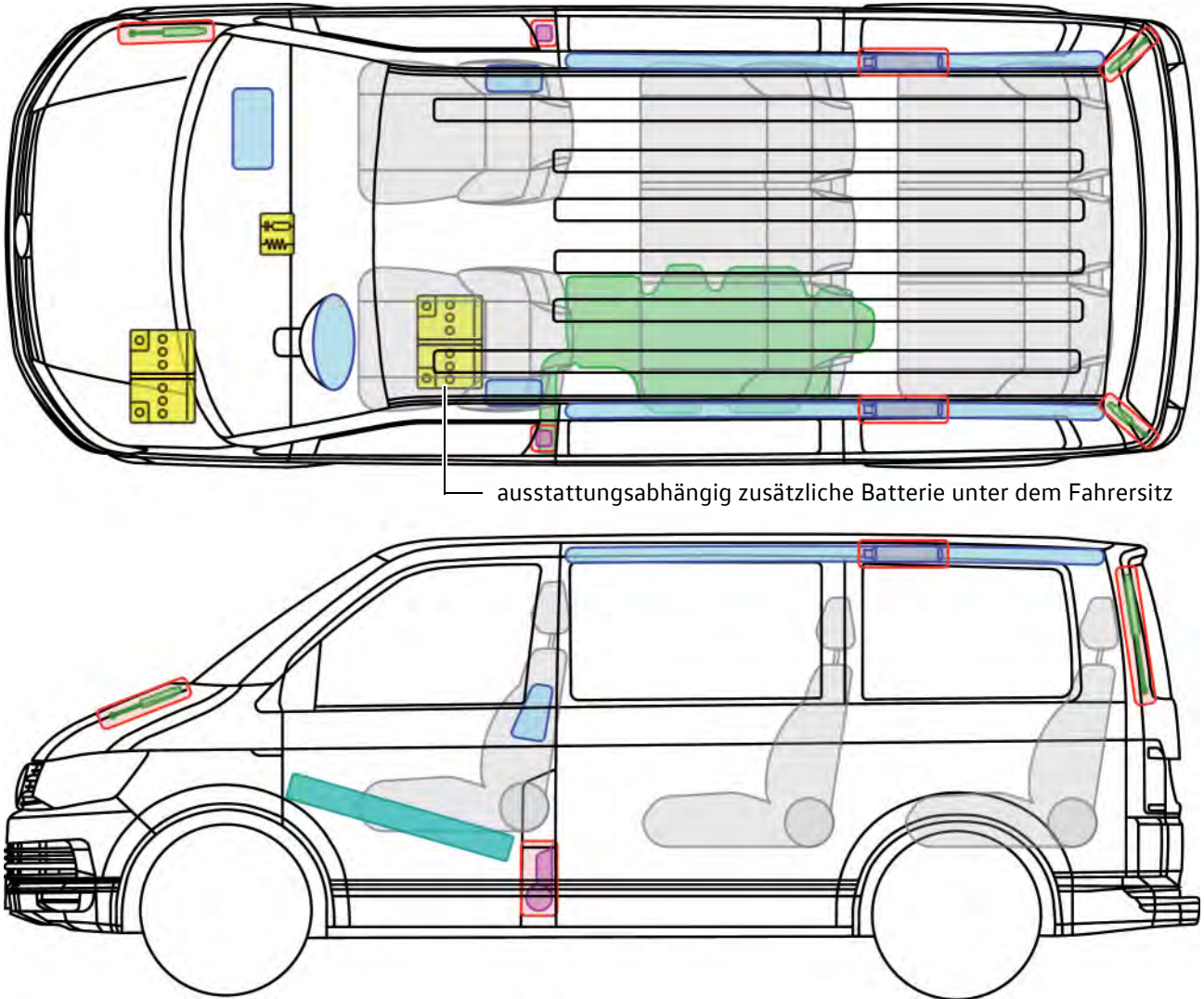



Transporter T6

(ab 2015)



ausstattungsabhängig zusätzliche Batterie unter dem Fahrersitz

Legende

	Airbag		Karosserie-Verstärkung		Steuergerät
	Gas-generator				12V-Batterie
	Gurtstraffer		Gasdruck-dämpfer		Kraftstoff-tank







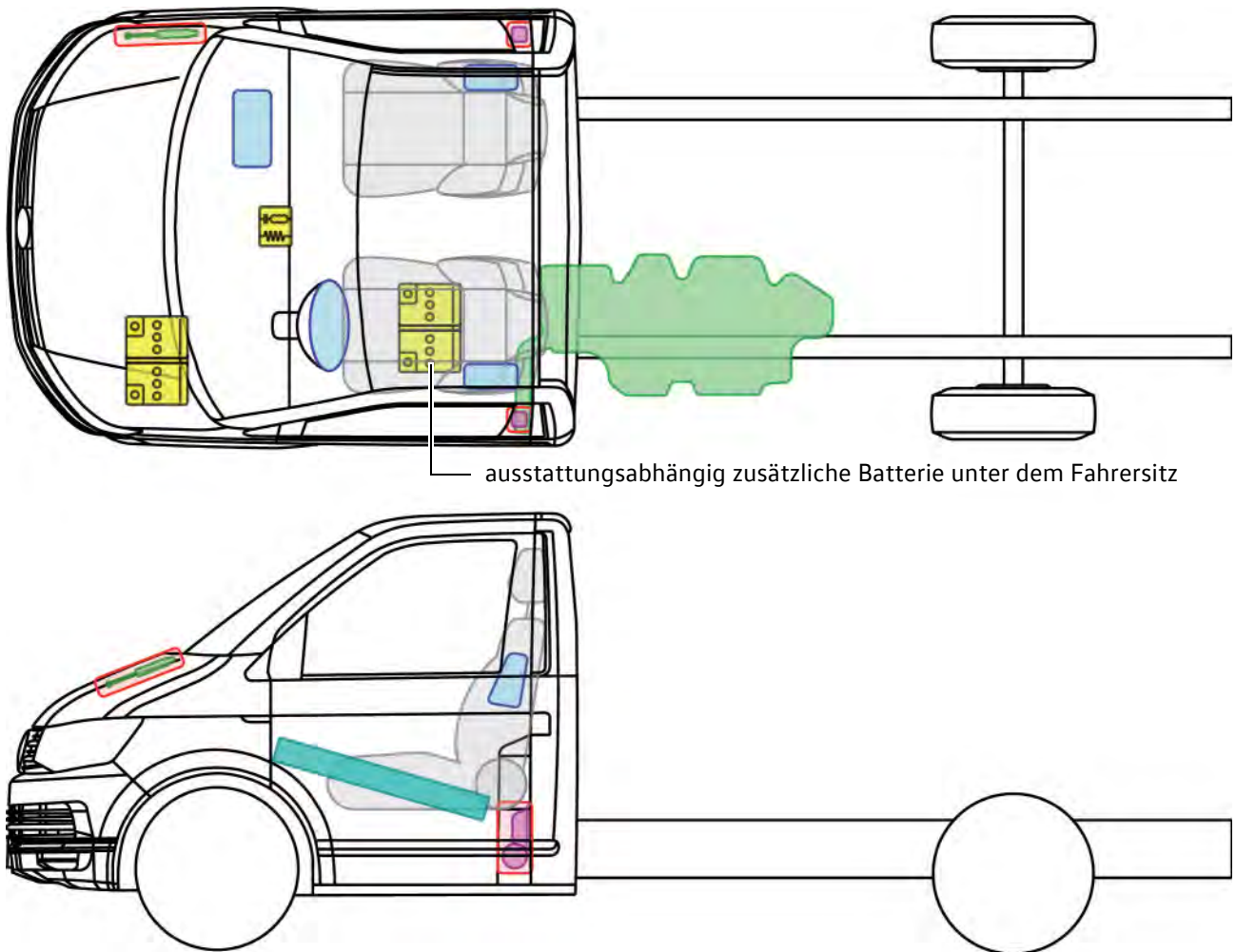

Transporter T6 Fahrgestell

(2-Türer, ab 2015)



ausstattungsabhängig zusätzliche Batterie unter dem Fahrersitz

Legende

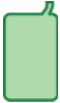
	Airbag		Karosserie-Verstärkung		Steuergerät	
					12V-Batterie	
	Gurtstraffer		Gasdruck-dämpfer		Kraftstoff-tank	







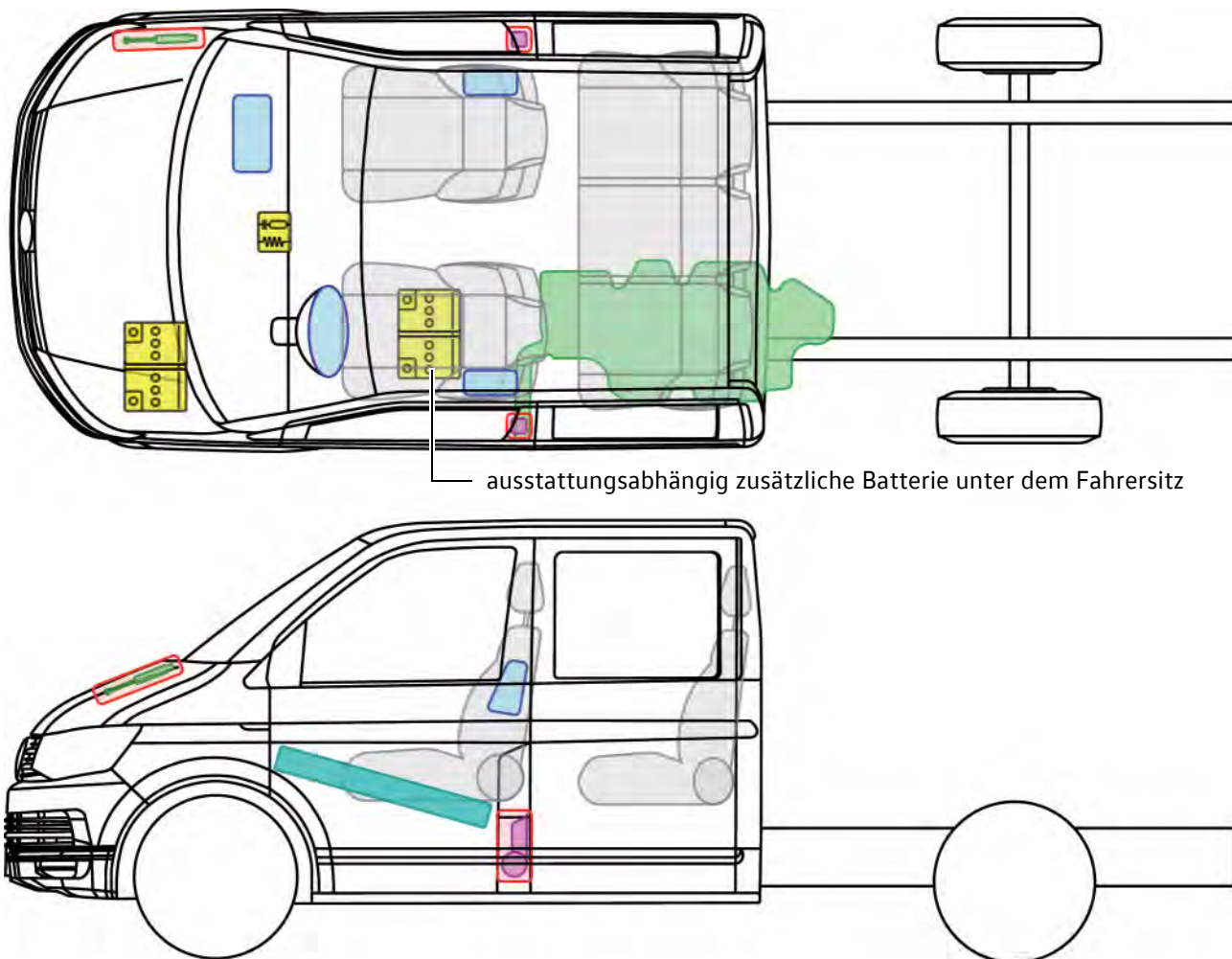

Transporter T6 Fahrgestell

(4-Türer, ab 2015)

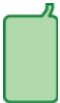

Legende

	Airbag		Karosserie-Verstärkung		Steuergerät
					12V-Batterie
	Gurtstraffer		Gasdruck-dämpfer		Kraftstoff-tank



Transporter T6 California



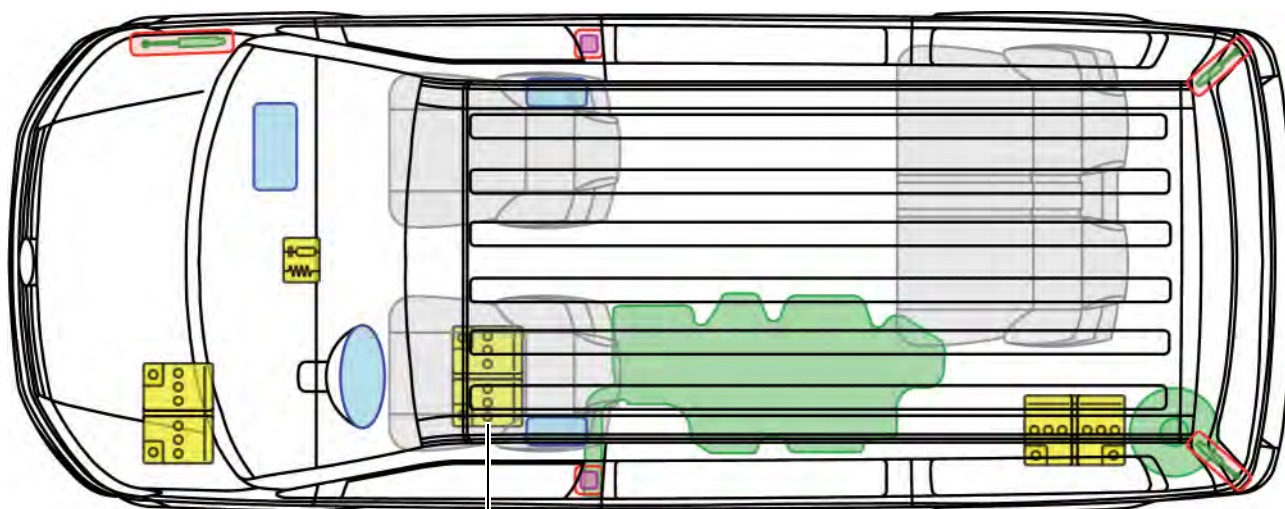



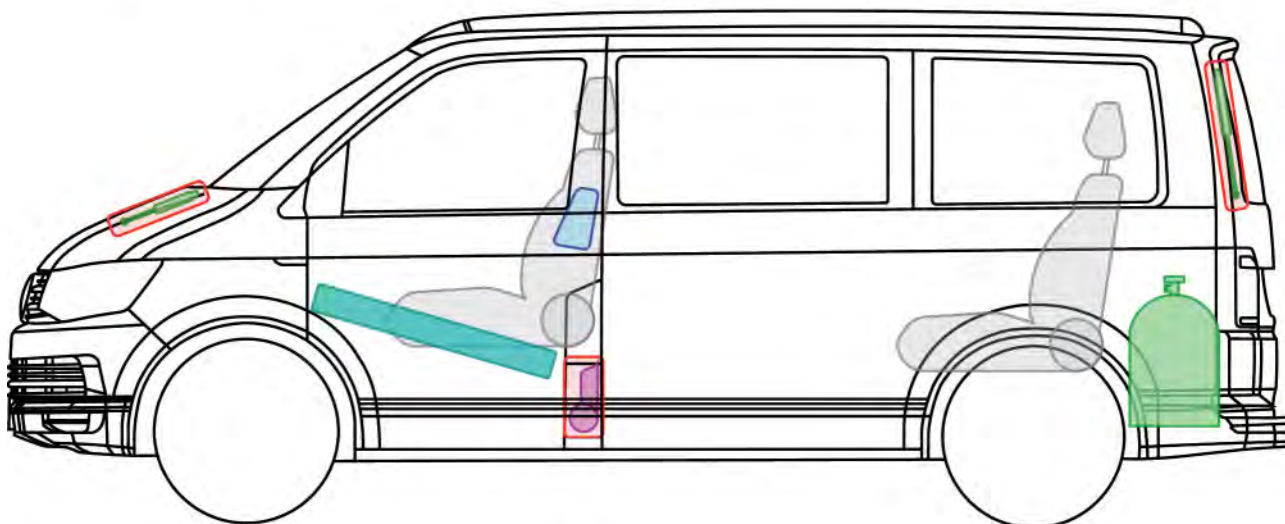

(ab 2015)



ausstattungsabhängig zusätzliche Batterie unter dem Fahrersitz



Legende





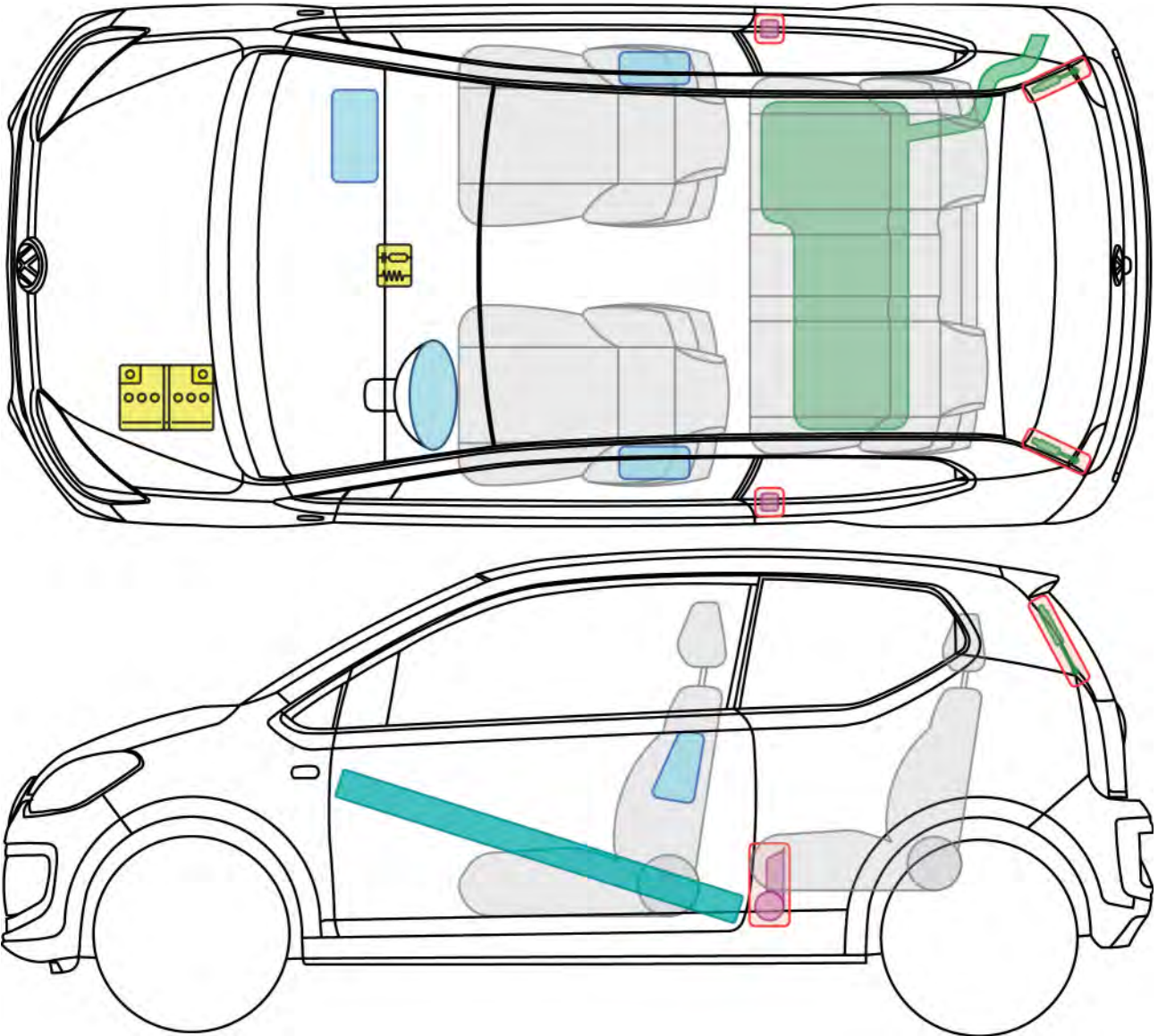

	Airbag		Karosserie-Verstärkung		Steuergerät		Gastank
					12V-Batterie		
	Gurtstraffer		Gasdruck-dämpfer		Kraftstoff-tank		



up!
(3-Türer, ab 2011)



Legende

	Airbag		Karosserie-Verstärkung		Steuergerät
					12V-Batterie
	Gurtstraffer		Gasdruck-dämpfer		Kraftstoff-tank

up! (3-Türer, ab 2011)

U







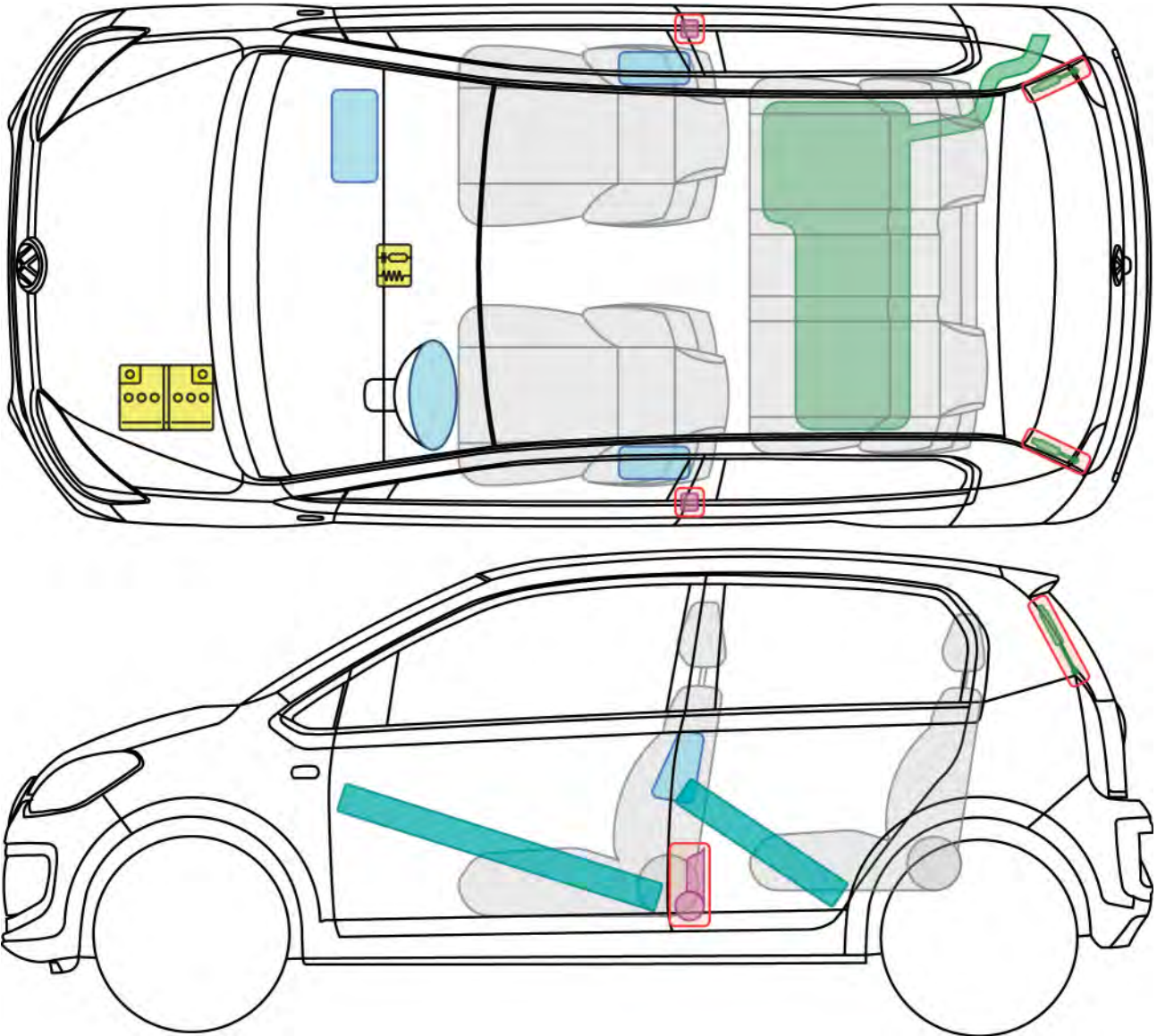

up!

(5-Türer, ab 2011)



Legende

	Airbag		Karosserie-Verstärkung		Steuergerät
					12V-Batterie
	Gurtstraffer		Gasdruck-dämpfer		Kraftstoff-tank

U

up! (5-Türer, ab 2011)



up!

(3-Türer, EcoFuel, ab 2013)

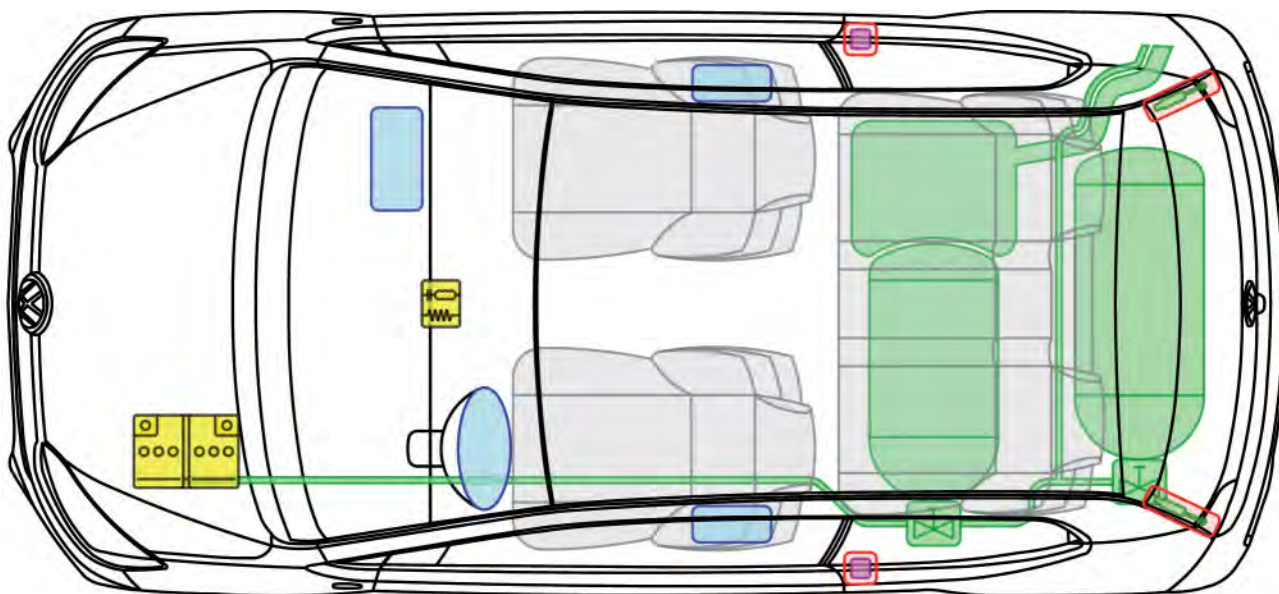





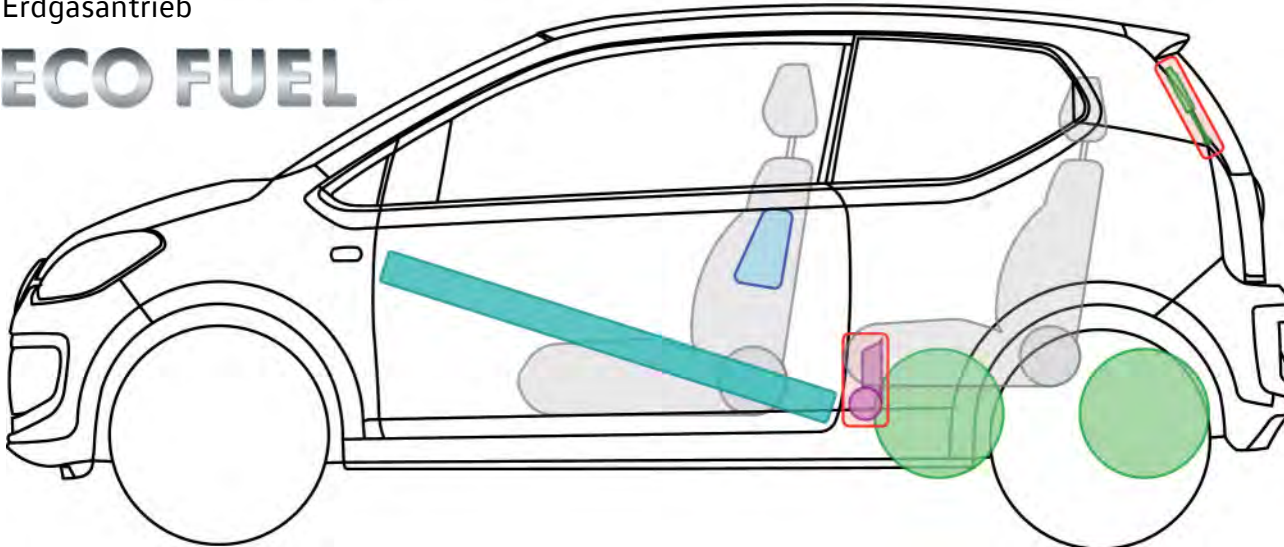



Erdgasantrieb

ECO FUEL



Legende

	Airbag		Karosserie-Verstärkung		Steuergerät		Gastank
					12V-Batterie		Sicherheits-ventil
	Gurtstraffer		Gasdruck-dämpfer		Kraftstoff-tank		



up! (3-Türer, EcoFuel, ab 2013)



up!

(3-Türer, EcoFuel, ab 2013)



Hinweise zur Erdgasanlage

Gastanks manuell absperren (bei Gasgeruch bzw. Austritt von Erdgas)

1. Zugang zu den Erdgastanks

- Der Zugang zu den Tanks erfolgt vom Unterboden aus.
- Die Gastanks sind durch eine Kunststoffabdeckung verkleidet. Um an die Erdgastanks zu gelangen, muss diese Abdeckung mit geeigneten Mitteln entfernt werden, ohne die darunter liegenden Bauteile der Gasanlage zu beschädigen.



elektromagnetische Absperrventile an den Gastanks

2. Absperrhähne lokalisieren

- Jeder Gastank besitzt ein eigenes Flaschenventil mit einem manuellen Absperrhahn.
- Falls einsatzbedingt erforderlich muss jeder Gastank separat abgesperrt werden.



manueller Absperrhahn am Fuß des Flaschenventils.

3. Gastank von Hand schließen

- Falls einsatzbedingt erforderlich muss jeder Gastank separat abgesperrt werden.
- Mit einem 5er-Maul- bzw. Ringschlüssel lässt sich das manuelle Absperrventil am Vierkant durch Drehen im Uhrzeigersinn bis zum Anschlag des Ventils verschließen.

U

up! (3-Türer, EcoFuel, ab 2013)



up!

(5-Türer, EcoFuel, ab 2013)

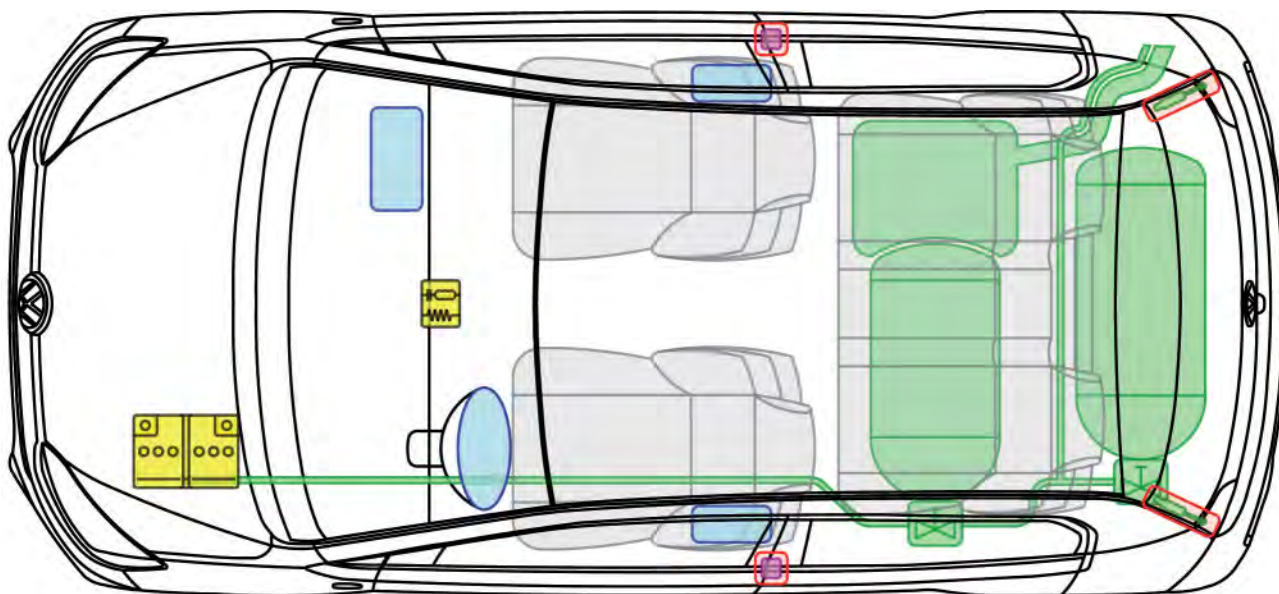





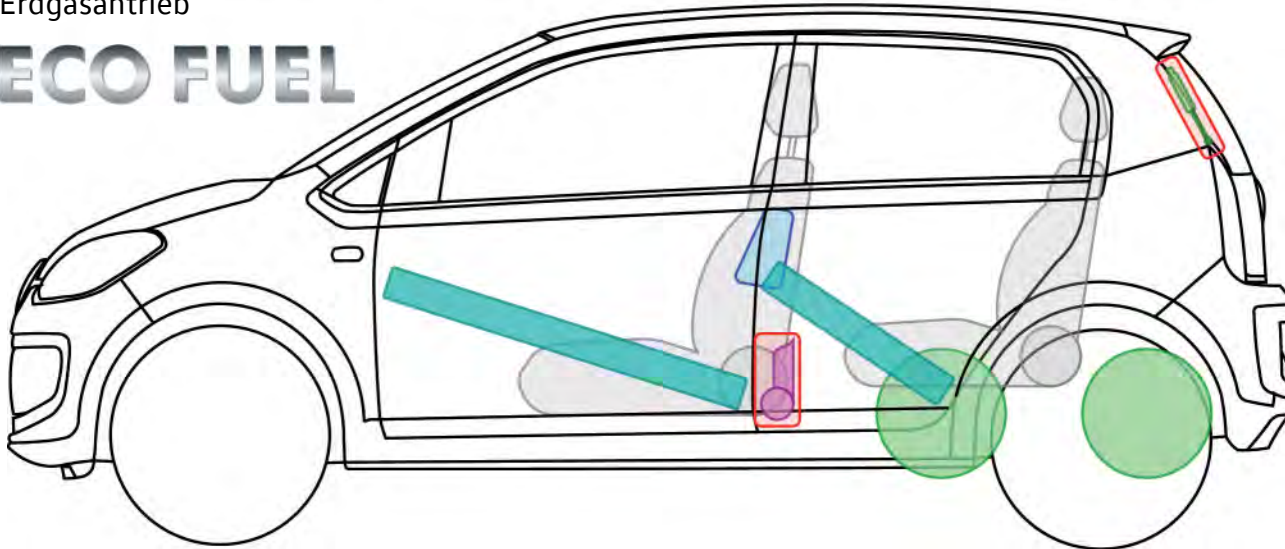



Erdgasantrieb

ECO FUEL



Legende

	Airbag		Karosserie-Verstärkung		Steuergerät		Gastank
					12V-Batterie		Sicherheits-ventil
	Gurtstraffer		Gasdruck-dämpfer		Kraftstoff-tank		



up! (5-Türer, EcoFuel, ab 2013)



up!

(5-Türer, EcoFuel, ab 2013)



Hinweise zur Erdgasanlage

Gastanks manuell absperren (bei Gasgeruch bzw. Austritt von Erdgas)

1. Zugang zu den Erdgastanks

- Der Zugang zu den Tanks erfolgt vom Unterboden aus.
- Die Gastanks sind durch eine Kunststoffabdeckung verkleidet. Um an die Erdgastanks zu gelangen, muss diese Abdeckung mit geeigneten Mitteln entfernt werden, ohne die darunter liegenden Bauteile der Gasanlage zu beschädigen.



elektromagnetische Absperrventile an den Gastanks

2. Absperrhähne lokalisieren

- Jeder Gastank besitzt ein eigenes Flaschenventil mit einem manuellen Absperrhahn.
- Falls einsatzbedingt erforderlich muss jeder Gastank separat abgesperrt werden.



manueller Absperrhahn am Fuß des Flaschenventils.

3. Gastank von Hand schließen

- Falls einsatzbedingt erforderlich muss jeder Gastank separat abgesperrt werden.
- Mit einem 5er-Maul- bzw. Ringschlüssel lässt sich das manuelle Absperrventil am Vierkant durch Drehen im Uhrzeigersinn bis zum Anschlag des Ventils verschließen.

U







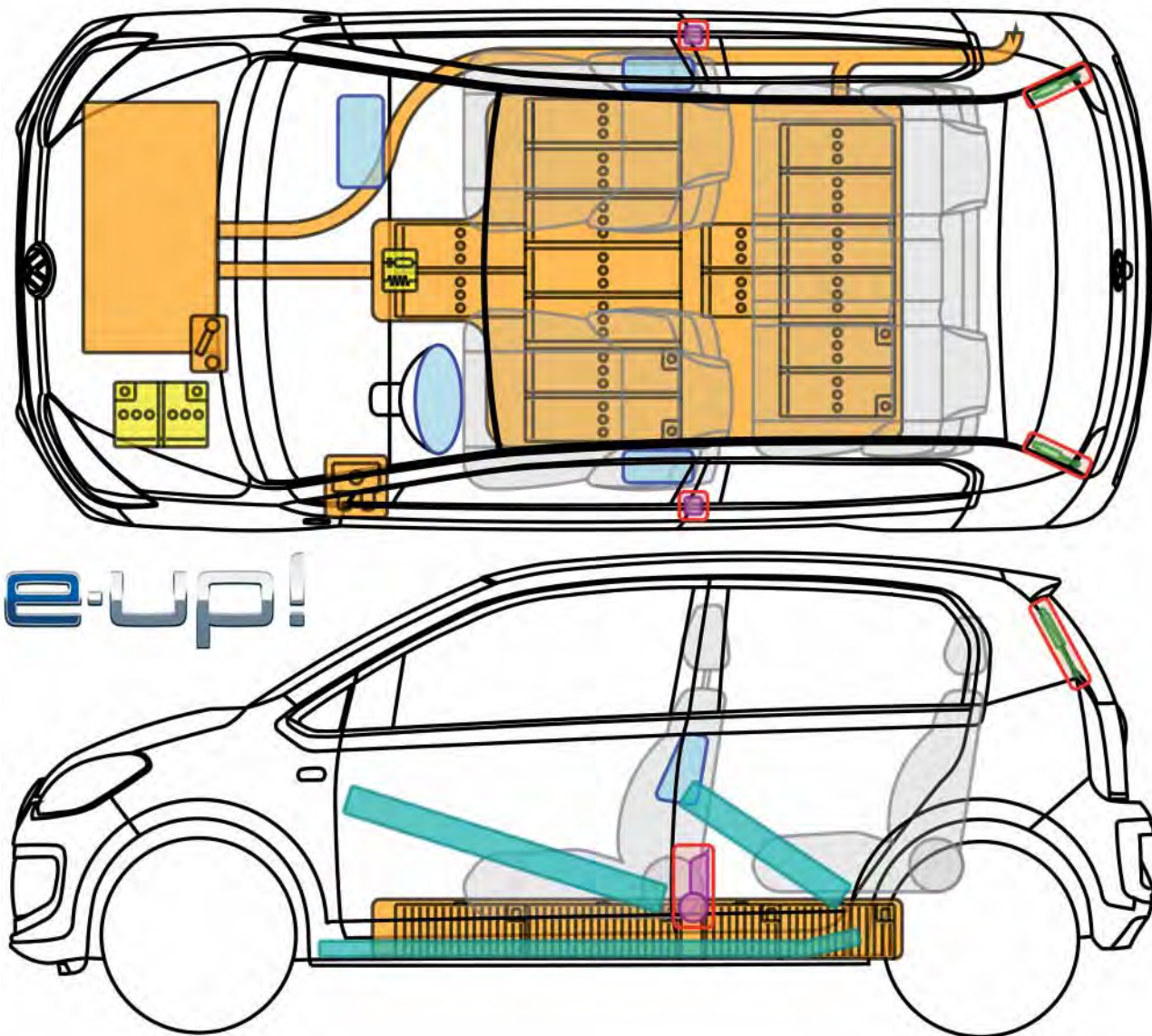



up! (5-Türer, EcoFuel, ab 2013)



e-up!
(ab 2013)



Legende

	Airbag		Karosserie-Verstärkung		Steuergerät		Hochvolt-batterie
	Gas-generator				12V-Batterie		Hochvolt-komponente/-leitung
	Gurtstraffer		Gasdruck-dämpfer		Kraftstoff-tank		Trennstelle für Hochvolt

e-up! (ab 2013)

U



e-up!
(ab 2013)



Fahrzeugidentifizierung

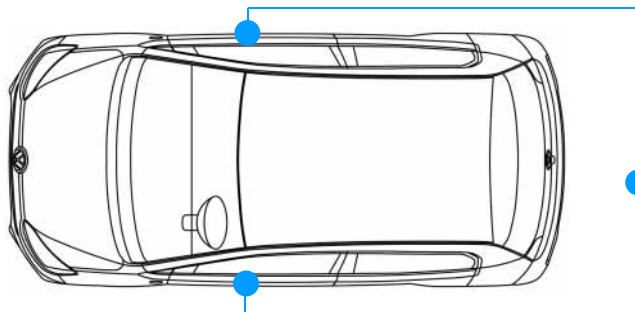

Schriftzug auf den Türen und auf der Heckklappe



Fahrzeug gegen Wegrollen sichern

1. Gangwahlhebel in Stellung „P“ bringen.
2. Feststellbremse betätigen.

Antrieb und Hochvoltsystem deaktivieren

Antrieb und Hochvoltsystem deaktivieren

(Zündung und Sicherungsträger im Innenraum zugänglich)

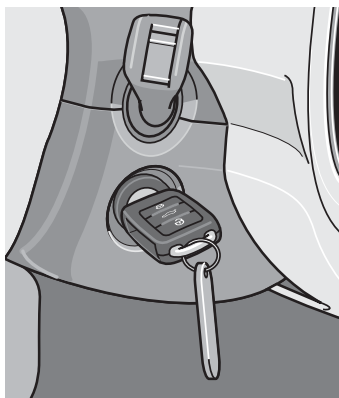

1. Zündschlüssel in „AUS-Stellung“ drehen und abziehen.



Die passiven Sicherheitssysteme wie Airbags und Gurtstraffer sind nach Ablauf der Entladungszeit des Airbagsteuergerätes von ca. 4 Sekunden durch das Drehen des Zündschlüssels in die Stellung „AUS“ deaktiviert. Vor Ablauf der Entladungszeit besteht eine Gefahr der Airbagauslösung aufgrund der Beschädigung des Airbagsystems.

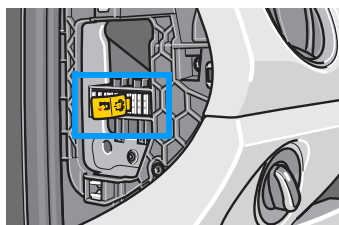

2. Abdeckung Sicherungsträger der Schalttafel links entfernen. **Gekennzeichnete Sicherung herausziehen.** (gelbe Fahne)



Das Hochvoltsystem ist nach dem Deaktivieren innerhalb von ca. 20 Sekunden spannungsfrei. Die passiven Sicherheitssysteme wie Airbags und Gurtstraffer sind dann deaktiviert.



e-up!
(ab 2013)



Antrieb und Hochvoltsystem deaktivieren

Antrieb und Hochvoltsystem deaktivieren (Motorraum zugänglich)

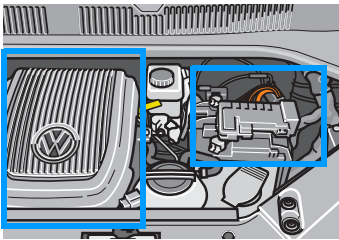

1. 12-V-Batterie abklemmen
2. Designabdeckung entfernen

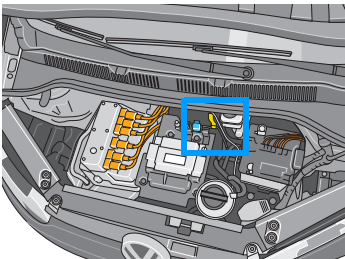

3. Rettungstrennstelle lokalisieren

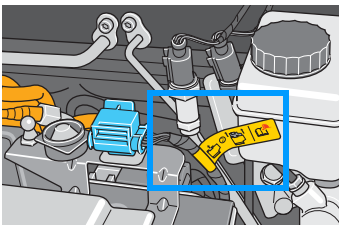

4. Rettungstrennstelle öffnen
Vorgehensweise ist auf dem Label beschrieben!



Das Hochvoltsystem ist nach dem Deaktivieren innerhalb von ca. 20 Sekunden spannungsfrei. Die passiven Sicherheitssysteme wie Airbags und Gurtstraffer sind dann deaktiviert.



An der Ladesäule angeschlossenes Fahrzeug

Fahrzeug entriegeln. Das Ladekabel vom Fahrzeug trennen und ggf. bei schweren Unfällen das Hochvoltsystem des Fahrzeugs deaktivieren (siehe unter „Fahrzeug deaktivieren“)!







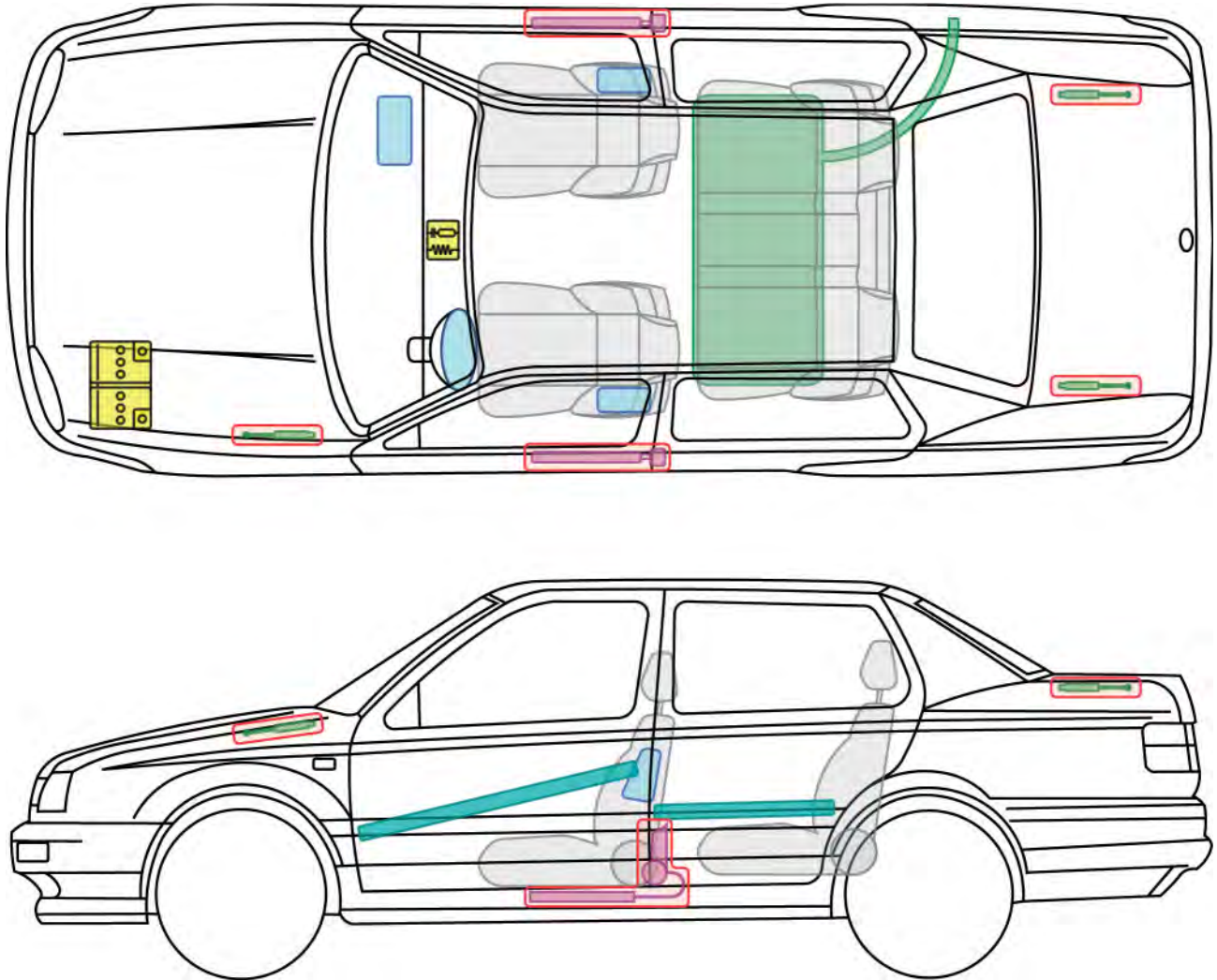

Vento

(ab 1992)

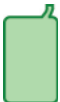

Legende

	Airbag		Karosserie-Verstärkung		Steuergerät	
					12V-Batterie	
	Gurtstraffer		Gasdruck-dämpfer		Kraftstoff-tank	



XL1 (Europa ab 2014)

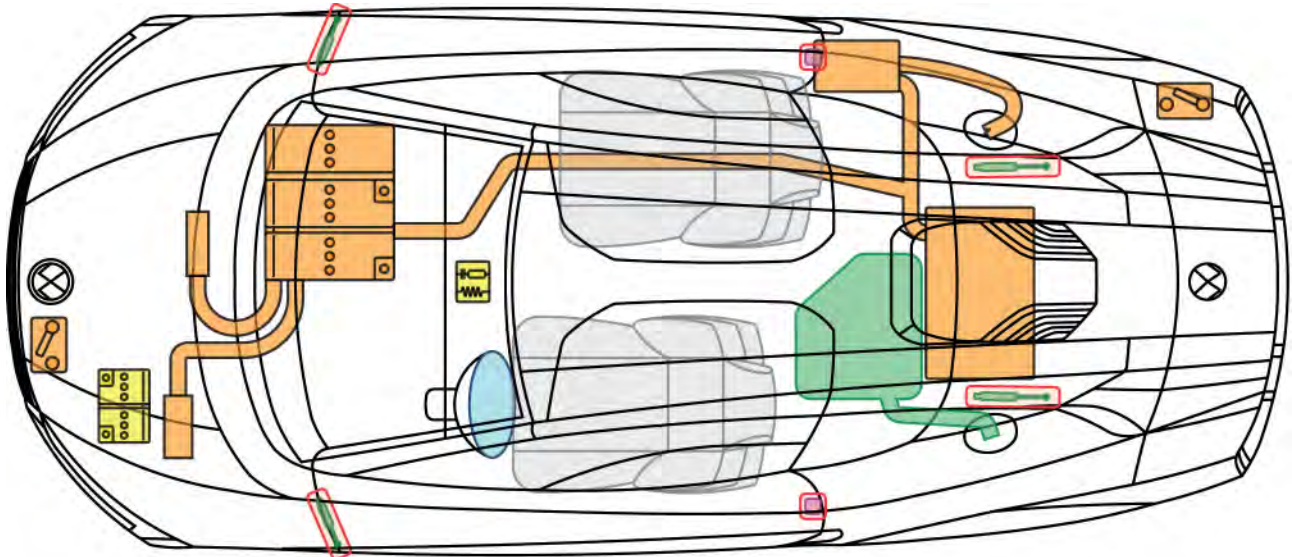





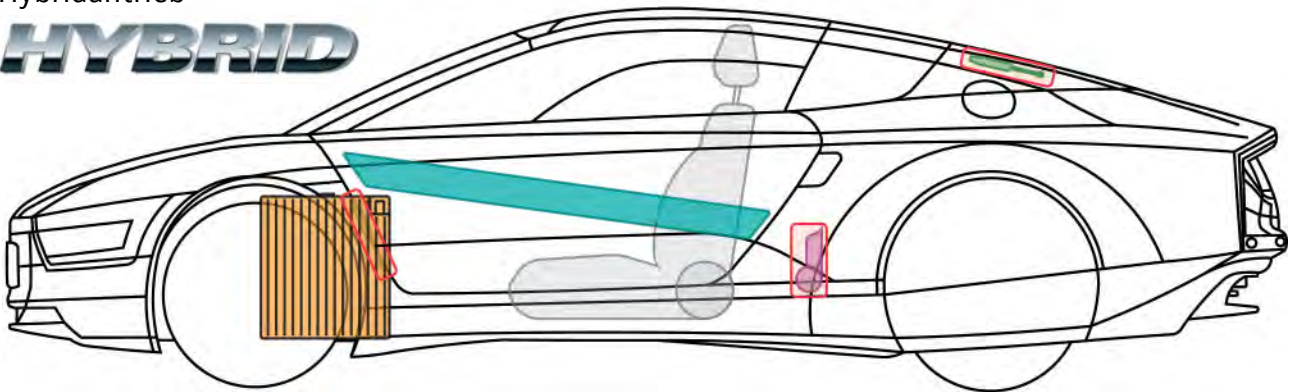





Hybridantrieb

HYBRID



i Die Karosserie des Fahrzeuges besteht aus Kohlefaser-Verbundwerkstoff.

Legende

	Airbag		Karosserie-Verstärkung		Steuergerät		Hochvolt-batterie
	Gas-generator				12V-Batterie		Hochvolt-leitung/-komponente
	Gurtstraffer		Gasdruck-dämpfer		Kraftstoff-tank		Trennstelle für Hochvolt



XL1

(Europa ab 2014)



Fahrzeugidentifizierung

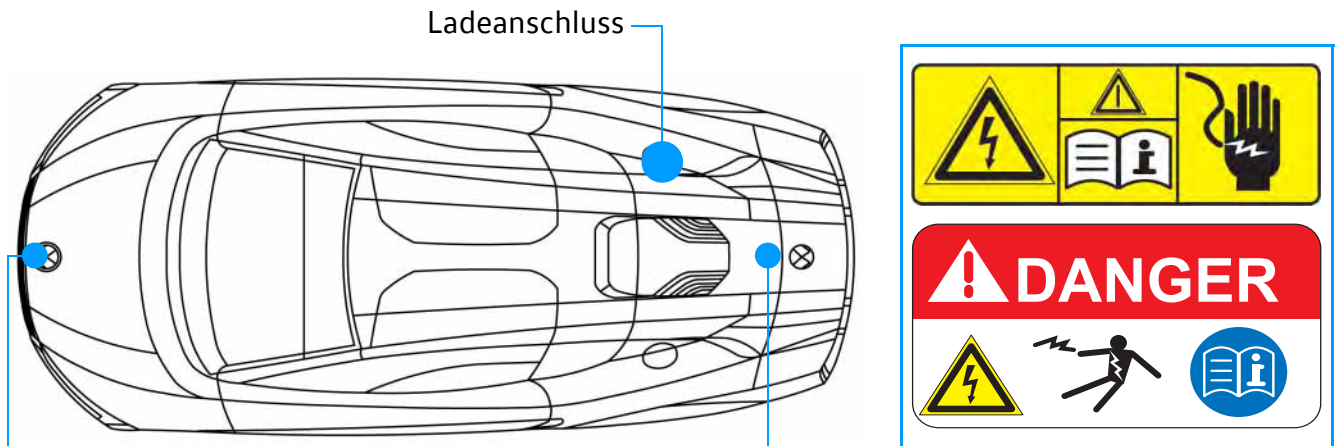

Hochvolt-Warnhinweise unter der Fronthaube und unter der Heckklappe



Fahrzeugdesign:

Das Fahrzeug ist einmalig in seiner Formgebung und verfügt über einen Ladeanschluss.

Fahrzeug gegen Wegrollen sichern

1. Fahrzeug von außen gegen Wegrollen sichern.
2. Gangwahlhebel auf Stellung „P“ setzen.
3. Elektrische Feststellbremse betätigen.

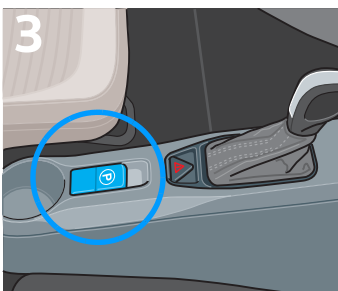

- Der Taster der elektrischen Feststellbremse in der Mittelkonsole zwischen Gangwahlhebel und Getränkehalter ist mit „P“ gekennzeichnet.

X

XL1 (Europa ab 2014)



XL1

(Europa ab 2014)



Fahrzeug deaktivieren

Antrieb und Hochvoltsystem deaktivieren

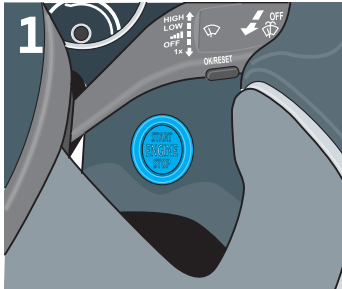

1. START/STOP-Knopf drücken

- Der START/STOP-Knopf befindet sich in Fahrtrichtung gesehen rechts, hinter dem Lenkrad.

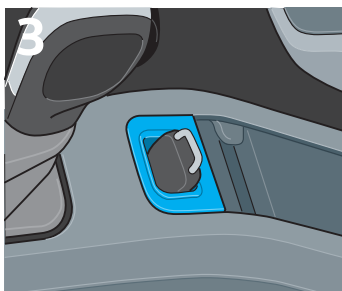

2. Deaktivierung anhand der Beleuchtung des START/STOP-Knopfs kontrollieren

- Ist die Beleuchtung des START/STOP-Knopfs ausgeschaltet, ist die Fahrbereitschaft des Fahrzeugs deaktiviert.

3. Zündschlüssel aus dem Zündschloss in der Mittelkonsole herausziehen und mindestens 5 Meter vom Fahrzeug entfernen.

- Das Zündschloss befindet sich in Fahrtrichtung gesehen vor dem Gangwählhebel, in der Mittelkonsole.

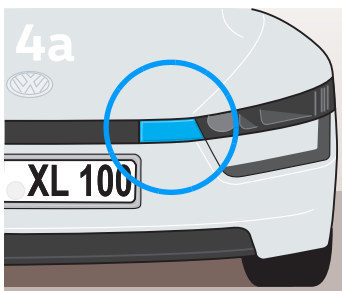

UND ZUSÄTZLICH

4a. Rettungstrennstelle am Fahrzeug vorne trennen

- Die Rettungstrennstelle befindet sich in Fahrtrichtung links vorn, hinter einer Service-Klappe.
Die Service-Klappe kann von außen entfernt werden.
- Service-Klappe entfernen.
- Rettungstrennstelle anhand der gelben Markierung lokalisieren. Die Vorgehensweise zum Trennen ist auf der Markierung beschrieben.
- 12V-Leitung gemäß der auf der Markierung vorgegebener Vorgehensweise trennen.

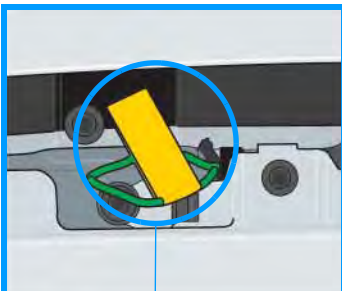

X

XL1 (Europa ab 2014)



XL1

(Europa ab 2014)



Fahrzeug deaktivieren

Antrieb und Hochvoltssystem deaktivieren (Fortsetzung)

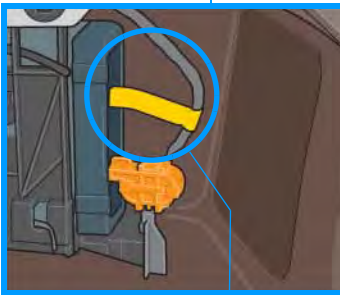
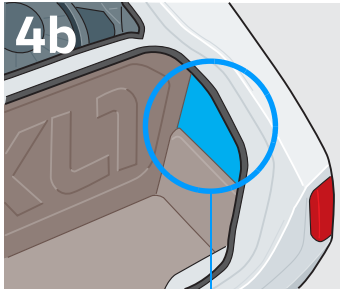

ODER

4b. Rettungstrennstelle am Fahrzeug hinten trennen

- Die Rettungstrennstelle befindet sich in Fahrtrichtung rechts im Gepäckraum, unter einer Service-Klappe.
- Service-Klappe entfernen.
- Rettungstrennstelle anhand der gelben Markierung lokalisieren. Die Vorgehensweise zum Trennen ist auf der Markierung beschrieben.
- 12V-Leitung gemäß der auf der Markierung vorgegebener Vorgehensweise trennen.



Innerhalb von ca. 15 Sekunden nach der Deaktivierung wird das Hochvoltssystem deaktiviert.

Danach ist das Hochvoltssystem, mit Ausnahme der Hochvoltbatteriespannungsfrei und die passiven Sicherheitssysteme wie Airbags und Gurtstraffer deaktiviert.

Nach Betätigung des START/STOP-Knopfs, dem Entfernen des Schlüssels und dem Abklemmen der 12V-Bordnetzbatterie sind die passiven Sicherheitssysteme wie Airbags und Gurtstraffer nach Ablauf der Entladungszeit des Airbagsteuergerätes von ca. 4 Sekunden deaktiviert.

Vor Ablauf der Entladungszeit besteht eine Gefahr der Airbagauslösung aufgrund der Beschädigung des Airbagsystems.



Bei Unfällen mit Fahrerairbagauslösung wird das Hochvoltssystem automatisch deaktiviert.

Vor jeglichen Arbeiten an einem Fahrzeug mit Hochvoltssystem ist dieses von der Ladeinfrastruktur zu trennen.



XL1

(Europa ab 2014)



Fahrzeug deaktivieren

Airbag und Gurtstraffer deaktivieren

Zusätzlich besteht die Möglichkeit, die 12V-Bordnetzbatterie vom 12V-Bordnetz abzutrennen und damit die Airbags und Gurtstraffer zu deaktivieren.



Bei aktiviertem Hochvoltsystem führt das Abklemmen der 12V-Bordnetzbatterie **NICHT** zur Deaktivierung des Hochvoltsystems.



Das Deaktivieren des Hochvoltsystems **MUSS** über die Rettungstrennstellen erfolgen.

1

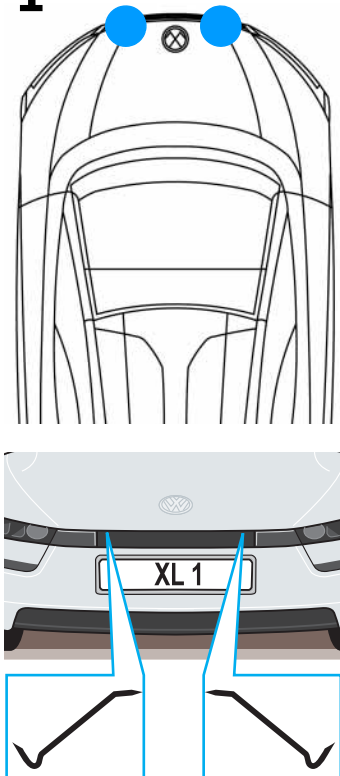

1. 12V-Bordnetzbatterie an der Masseverbindung vom 12V-Bordnetz trennen

- Die 12V-Bordnetzbatterie befindet sich unter der Fronthaube.
- **Die Fronthaube ist entgegen konventionellen Fahrzeugen fest mit der Karosserie verschraubt.**
- Fronthaube mit geeignetem Werkzeug von vorn an den Verschraubungen abhebeln, bis die Verschraubungen abscheren .
- Fronthaube entfernen.
- 12V-Bordnetzbatterie lokalisieren und Masseverbindung der 12V-Bordnetzbatterie trennen.

X

XL1 (Europa ab 2014)



XL1

(Europa ab 2014)



Weitere Informationen zum Fahrzeug

Dach- und Türsystem

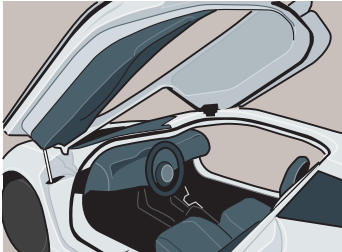

Das Fahrzeug verfügt über zwei Flügeltüren.

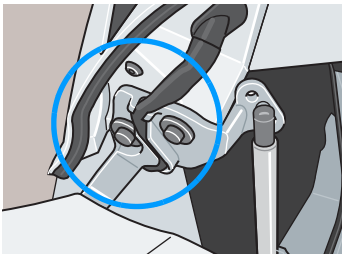

Die Flügeltüren sind mit Trennbolzen befestigt.

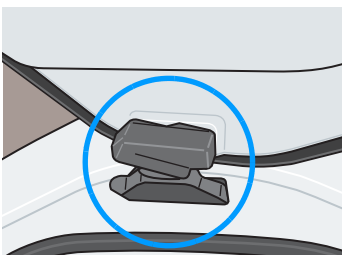

Im Crashfall (**nur bei Rollover**) werden die Trennbolzen automatisch getrennt und die Türen lassen sich entfernen.

X

XL1 (Europa ab 2014)

An der Ladesäule angeschlossenes Fahrzeug

Fahrzeug entriegeln. Das Ladekabel vom Fahrzeug trennen und ggf. bei schweren Unfällen das Hochvoltssystem des Fahrzeugs deaktivieren (siehe unter „Fahrzeug deaktivieren“)!